

# SIEMENS

## SIMATIC

### ET 200S distributed I/O IM 151-8 PN/DP CPU interface module

#### Operating Instructions

Preface	
Description	1
Operating and display elements	2
Communication	3
PROFINET	4
Memory concept	5
Mounting and connecting	6
Addressing	7
Commissioning	8
Service and maintenance	9
Functions	10
Debugging functions, diagnostics and troubleshooting	11
Technical data	12
Appendix	A

## Legal information

### Warning notice system

This manual contains notices you have to observe in order to ensure your personal safety, as well as to prevent damage to property. The notices referring to your personal safety are highlighted in the manual by a safety alert symbol, notices referring only to property damage have no safety alert symbol. These notices shown below are graded according to the degree of danger.

<b>⚠ DANGER</b>
indicates that death or severe personal injury <b>will</b> result if proper precautions are not taken.
<b>⚠ WARNING</b>
indicates that death or severe personal injury <b>may</b> result if proper precautions are not taken.
<b>⚠ CAUTION</b>
with a safety alert symbol, indicates that minor personal injury can result if proper precautions are not taken.
<b>CAUTION</b>
without a safety alert symbol, indicates that property damage can result if proper precautions are not taken.
<b>NOTICE</b>
indicates that an unintended result or situation can occur if the corresponding information is not taken into account.

If more than one degree of danger is present, the warning notice representing the highest degree of danger will be used. A notice warning of injury to persons with a safety alert symbol may also include a warning relating to property damage.

### Qualified Personnel

The product/system described in this documentation may be operated only by **personnel qualified** for the specific task in accordance with the relevant documentation for the specific task, in particular its warning notices and safety instructions. Qualified personnel are those who, based on their training and experience, are capable of identifying risks and avoiding potential hazards when working with these products/systems.

### Proper use of Siemens products

Note the following:

<b>⚠ WARNING</b>
Siemens products may only be used for the applications described in the catalog and in the relevant technical documentation. If products and components from other manufacturers are used, these must be recommended or approved by Siemens. Proper transport, storage, installation, assembly, commissioning, operation and maintenance are required to ensure that the products operate safely and without any problems. The permissible ambient conditions must be adhered to. The information in the relevant documentation must be observed.

### Trademarks

All names identified by ® are registered trademarks of the Siemens AG. The remaining trademarks in this publication may be trademarks whose use by third parties for their own purposes could violate the rights of the owner.

### Disclaimer of Liability

We have reviewed the contents of this publication to ensure consistency with the hardware and software described. Since variance cannot be precluded entirely, we cannot guarantee full consistency. However, the information in this publication is reviewed regularly and any necessary corrections are included in subsequent editions.

# Preface

## Purpose of the operating instructions

These operating instructions are intended to supplement the *ET 200S Distributed I/O System* Operating Instructions. It contains a description of all the functions performed by the IM 151-8 PN/DP CPU interface module. The operating instructions do not include functions that relate generally to ET 200S. These can be found in the *ET 200S Distributed I/O System* Operating Instructions.

The information contained in these operating instructions and the *ET 200S Distributed I/O System* Operating Instructions allows you to commission ET 200S with the IM 151-8 PN/DP CPU interface module and to run it as an IO controller on the PROFINET. You will also find information on how the IM 151-8 PN/DP CPU interface module can be operated together with the DP master module on the PROFIBUS DP.

## Basic knowledge required

To understand these operating instructions you should have general experience in the field of automation engineering.

## Range of validity of these operating instructions

These Operating Instructions are valid for

- the IM 151-8 PN/DP CPU interface module (order number 6ES7151-8AB01-0AB0)
- the DP master module (order number 6ES7138-4HA00-0AB0)
- the components of the ET 200S distributed I/O system specified in the *ET 200S Distributed I/O System* Operating Instructions.

---

### Note

A description of the special features of the interface module IM151-8F PN/DP CPU can be found in the product information on the Internet (<http://support.automation.siemens.com/WW/view/en/29713139>).

---

These operating instructions contain a description of the components that was valid at the time of publication. We reserve the right to issue a Product Information which contains up-to-date information about new components and new versions of components.

## Changes since the previous version

The following changes have been made compared with the previous version of these *Distributed I/O ET 200S, interface module IM151-8 PN/DP CPU* operating instructions, edition 06/2008, A5E02049033-01:

- **PROFINET**
  - Support of isochronous real-time communication with "high performance"
  - Support of isochronous mode on PROFINET
  - Media redundancy
  - can be configured as an I device
  - Shared Device
  - IP parameters are configurable via the DCP (Discovery and Configuration Protocol) or SFB 104 "IP\_CONF"
  - Configuration and operation of I/O transfer areas in the case of operation as an I device (direct access by a higher level IO controller to the local IM151-8 CPU I/O as an I device)
  - Initialized for PROFINergy (SFB 73 / SFB 74)
  - Keep Alive function supported
- **Open communication via Industrial Ethernet**
  - Increased data lengths during open communication
  - Several connections can be established for each port
  - Using TCP/IP: several passive connections can be established for a port (multi-port)
  - Extended system diagnostics of PROFINET interface:  
Overview and detailed diagnostics of connections of "open communication via Industrial Ethernet"

- **Additional web server functionality**
  - Users can be configured for login
  - Connections via http(s)
  - Module state
  - Display of the communication connections during open communication via Industrial Ethernet (OUC)
  - Extended connection diagnostics during open communication
  - Display of resources during communication
  - Display of the port statistics of IO devices
  - Topology
  - User pages (new SFC 99 required)
  - Link to Web servers of other configured devices
  - Status overview of all configured devices of the PROFINET IO system
  - Automatic page update for all dynamic pages on the Web server
  - Diagnostic buffer entries and messages can be downloaded as CSV file.
- **Further functionalities**
  - Increased work memory
  - Increased performance due to shorter instruction processing times
  - Reading out service data
  - Number of blocks that can be monitored using the status block increased from 1 to 2
  - Effective from STEP 7 V5.5, increase in the status information that can be monitored using the status block
  - Number of breakpoints increased from 2 to 4
  - Supports the status byte for power modules
  - Encryption of blocks using S7 Block Privacy
  - Local data stack size increased (32 kB per execution level/2 kB per block)
  - Expansion of the block number range
  - Time-delay interrupts: uniform OB 21 / OB 22
  - Cyclic interrupts: uniform OB 32 - OB 35
  - Number of displayed diagnostic buffer entries in CPU RUN mode is configurable
  - Extension of the diagnostic buffer entries in the event of problems on the local I/O bus of the IM151-8 PN/DP CPU
  - Extension of the SFC 12 by 2 new modes for triggering the OB 86 when activating / deactivating PROFIBUS slaves or PROFINET IO devices

## Guide

The operating instructions contain the following guides which provide quick access to the specific information you need:

- At the beginning of the documentation you will find a comprehensive table of contents.
- Important terms are explained in the glossary.
- Navigate to the most important topics in our documents using the index.

## Recycling and disposal

The IM 151-8 PN/DP CPU interface module is recyclable due to its non-toxic materials. For environmentally compliant recycling and disposal of your electronic waste, please contact a company certified for the disposal of electronic waste.

## Further support

If you have any questions relating to the products described in these operating instructions, and do not find the answers in this document, please contact your Siemens partner at our local offices.

You will find information on who to contact on the Web (<http://www.siemens.com/automation/partner>).

A guide to the technical documentation for the various SIMATIC products and systems is available in the Internet (<http://www.siemens.com/automation/simatic/portal>).

The online catalog and ordering systems are available on the Internet (<http://www.siemens.com/automation/mall>).

## Training center

We offer courses to help you get started with the ET 200S and the SIMATIC S7 automation system. Please contact your regional training center or the central training center in D -90327, Nuremberg, Germany.

You will find more information on the Web (<http://www.siemens.com/sitrain>).

## Service & Support on the Internet

In addition to our documentation, we offer a comprehensive knowledge base on the Internet (<http://www.siemens.com/automation/service&support>).

There you will find:

- Our Newsletter, which constantly provides you with the latest information about your products.
- The right documentation for you using our Service & Support search engine.
- The bulletin board, a worldwide knowledge exchange for users and experts.
- Your local contact for Automation & Drives in our contact database.
- Information about on-site service, repairs, spare parts, and much more is available under "Repairs, spare parts, and consulting".

## See also

Support (<http://support.automation.siemens.com/WW/view/en/11669702/133300>)





# Table of contents

	<b>Preface .....</b>	<b>3</b>
<b>1</b>	<b>Description.....</b>	<b>15</b>
1.1	Function of the IM 151-8 PN/DP CPU interface module .....	15
1.2	Properties of the IM 151-8 PN/DP CPU interface module.....	16
1.3	Properties of the DP master module.....	19
1.4	Example configurations.....	20
<b>2</b>	<b>Operating and display elements .....</b>	<b>23</b>
2.1	Operating and display elements of the IM 151-8 PN/DP CPU interface module .....	23
2.2	Status and error displays of the IM 151-8 PN/DP CPU interface module .....	25
2.3	Display elements of the DP master module.....	26
<b>3</b>	<b>Communication.....</b>	<b>27</b>
3.1	Interfaces .....	27
3.1.1	PROFINET (PN).....	27
3.1.2	PROFIBUS DP.....	32
3.2	Communication services.....	33
3.2.1	Overview of communication services .....	33
3.2.2	PG communication.....	35
3.2.3	OP communication.....	36
3.2.4	S7 communication .....	36
3.2.5	Routing.....	37
3.2.6	Data set routing.....	38
3.2.7	Data consistency.....	40
3.3	SNMP communication service.....	40
3.4	Open communication via Industrial Ethernet.....	41
3.5	S7 connections .....	44
3.5.1	S7 connection as communication path.....	44
3.5.2	Assignment of S7 connections.....	45
3.5.3	Distribution and availability of S7 connection resources .....	47
3.5.4	Connection resources for routing.....	48
3.6	DPV1.....	49
3.7	.....	51
3.7.1	Language settings.....	54
3.7.2	Settings in HW Config, "Web" tab.....	56
3.7.3	Updating and saving information .....	59

3.7.4	Web pages .....	60
3.7.4.1	Start page with general CPU information.....	60
3.7.4.2	Identification .....	62
3.7.4.3	Diagnostic buffer .....	64
3.7.4.4	Module state.....	66
3.7.4.5	Messages .....	72
3.7.4.6	Communication .....	73
3.7.4.7	Topology.....	80
3.7.4.8	Variable status .....	87
3.7.4.9	Variable tables .....	88
3.7.4.10	User pages .....	91
<b>4</b>	<b>PROFINET .....</b>	<b>95</b>
4.1	Communication by means of PROFINET .....	95
4.1.1	Introduction .....	95
4.1.2	PROFINET IO and PROFINET CBA .....	96
4.1.3	PROFINET IO System .....	98
4.1.4	Blocks for PROFINET IO .....	100
4.2	Isochronous real time communication .....	103
4.3	Prioritized startup .....	103
4.4	Device replacement without removable media / PD .....	104
4.5	IO devices that can be switched during operation .....	105
4.6	Isochronous mode.....	105
4.7	I-Device .....	106
4.8	Shared Device.....	107
4.9	Media redundancy.....	108
<b>5</b>	<b>Memory concept .....</b>	<b>109</b>
5.1	Memory areas and retentive memory .....	109
5.1.1	Memory areas of the IM 151-8 PN/DP CPU interface module .....	109
5.1.2	Retentivity of load memory, system memory and RAM .....	110
5.1.3	Retentivity of memory objects .....	111
5.1.4	Address areas of system memory .....	113
5.1.5	Properties of the SIMATIC Micro Memory Card .....	116
5.2	Memory functions.....	117
5.2.1	General: Memory functions .....	117
5.2.2	Downloading user programs via SIMATIC Micro Memory Card to the IM 151-8 PN/DP CPU interface module .....	118
5.2.3	Handling blocks.....	119
5.2.3.1	Encryption of blocks .....	119
5.2.3.2	Download of new blocks or delta downloads .....	120
5.2.3.3	Uploading blocks .....	120
5.2.3.4	Deleting blocks.....	121
5.2.3.5	Compressing blocks.....	121
5.2.3.6	Promming (RAM to ROM).....	121
5.2.4	CPU memory reset and restart .....	121
5.2.5	Recipes .....	122
5.2.6	Measured value log files .....	124
5.2.7	Backup of project data to SIMATIC Micro Memory Card .....	126

<b>6</b>	<b>Mounting and connecting</b> .....	<b>127</b>
6.1	Content.....	127
6.2	Installing the IM 151-8 PN/DP CPU interface module .....	127
6.3	Connecting the IM 151-8 PN/DP CPU interface module .....	128
6.4	Installing and connecting the DP master module .....	131
<b>7</b>	<b>Addressing</b> .....	<b>133</b>
7.1	Addressing the I/O modules.....	133
7.1.1	Slot-oriented addressing of the centralized I/O modules.....	133
7.1.2	User-oriented addressing of the I/O Modules.....	136
7.2	Addressing on PROFIBUS DP.....	137
7.3	Addressing PROFINET IO .....	138
7.3.1	Addressing on PROFINET IO.....	138
7.3.2	Assignment of the IP address parameters and device name.....	139
<b>8</b>	<b>Commissioning</b> .....	<b>143</b>
8.1	Overview .....	143
8.2	Commissioning procedure .....	143
8.2.1	Procedure: Commissioning the hardware.....	143
8.2.2	Procedure: Software commissioning .....	145
8.3	Commissioning check list.....	147
8.4	Commissioning the modules.....	148
8.4.1	Inserting/Replacing a SIMATIC Micro Memory Card.....	148
8.4.2	Initial power on .....	150
8.4.3	Reset the IM 151-8 PN/DP CPU interface module using the mode selector switch .....	151
8.4.4	Formatting the SIMATIC Micro Memory Card .....	155
8.4.5	Resetting to the as-delivered state .....	156
8.4.6	Connecting a programming device / PC to the integrated PROFINET interface of the IM 151-8 PN/DP CPU interface module .....	158
8.4.7	Starting SIMATIC Manager.....	160
8.4.8	Monitoring and modifying I/Os .....	161
8.5	Commissioning PROFIBUS DP .....	165
8.5.1	Commissioning the PROFIBUS DP network .....	165
8.5.2	Commissioning the IM 151-8 PN/DP CPU interface module with DP master module as a DP master .....	166
8.5.3	Direct data exchange .....	170
8.6	Commissioning PROFINET IO .....	172
8.6.1	Requirements for commissioning PROFINET .....	172
8.6.2	Configuring and commissioning the PROFINET IO system .....	173
<b>9</b>	<b>Service and maintenance</b> .....	<b>181</b>
9.1	Overview .....	181
9.2	Backing up firmware on a SIMATIC Micro Memory Card.....	181
9.3	Updating the firmware.....	182
9.3.1	When should you update the IM 151-8 PN/DP CPU interface module? .....	182
9.3.2	Firmware update using a SIMATIC Micro Memory Card.....	183
9.3.3	Updating the firmware online (via networks).....	185
9.4	Backing up project data on a SIMATIC Micro Memory Card.....	186
9.5	Replacing the IM 151-8 PN/DP CPU interface module .....	188
9.6	Replacing the DP master module .....	190

<b>10</b>	<b>Functions</b> .....	<b>193</b>
10.1	Assigning parameters of the reference junction for the connection of thermocouples.....	193
10.2	Removal and insertion of modules during operation .....	195
10.2.1	Overview .....	195
10.2.2	What happens when modules are removed during operation .....	196
10.2.3	Procedure when modules are inserted during operation .....	196
10.3	Switching power modules off and on during operation .....	198
10.4	Power module with status byte .....	199
<b>11</b>	<b>Debugging functions, diagnostics and troubleshooting</b> .....	<b>201</b>
11.1	Overview .....	201
11.2	Reading/saving service data .....	201
11.3	Identification and maintenance data of the IM 151-8 PN/DP CPU interface module .....	202
11.4	Debugging functions .....	204
11.4.1	Overview: Debugging functions .....	204
11.4.2	Overview: Diagnostics.....	207
11.4.3	Diagnostic functions available in STEP 7 .....	210
11.4.4	Network infrastructure diagnostics (SNMP).....	211
11.5	Diagnostics using status and error LEDs.....	213
11.5.1	Introduction .....	213
11.5.2	Status and error displays of the IM 151-8 PN/DP CPU interface module .....	213
11.5.3	Evaluating the SF LED in case of software errors .....	215
11.5.4	Evaluating the SF LED in case of hardware errors.....	217
11.5.5	Status and error displays for the PN interface .....	219
11.5.6	Status and Error Indicators: PROFINET IO Devices .....	222
11.5.7	Status and error displays of the DP master module .....	223
11.6	Diagnostics on the PROFIBUS DP .....	224
11.6.1	Diagnostics of the IM 151-8 PN/DP CPU interface module as a DP master.....	224
11.7	Defective configuration statuses of the ET 200S.....	227
11.8	Failure of the load voltage from the power module.....	227
11.9	Basics of diagnostics in PROFINET IO.....	228
<b>12</b>	<b>Technical data</b> .....	<b>229</b>
12.1	General technical data .....	229
12.2	IM 151-8 PN/DP CPU interface module.....	229
12.2.1	IM 151-8 PN/DP CPU with DP master module block diagram .....	229
12.2.2	IM 151-8 PN/DP CPU technical specifications .....	230
12.3	DP master module .....	242
12.3.1	Technical specifications - DP master module .....	242

---

<b>A</b>	<b>Appendix.....</b>	<b>243</b>
A.1	Order numbers.....	243
A.1.1	Module order numbers.....	243
A.1.2	Order numbers of accessories.....	244
A.2	Dimension drawings.....	245
A.2.1	IM 151-8 PN/DP CPU interface module.....	245
A.2.2	DP master module.....	246
A.3	Cycle and response times.....	246
A.3.1	Overview.....	246
A.3.2	Cycle time.....	247
A.3.2.1	Overview: Cycle time.....	247
A.3.2.2	Calculating the cycle time.....	250
A.3.2.3	Communication load.....	252
A.3.2.4	Cycle time extension as a result of testing and commissioning functions.....	254
A.3.3	Response time.....	255
A.3.3.1	Overview: Response time.....	255
A.3.3.2	Shortest response time.....	257
A.3.3.3	Longest response time.....	258
A.3.4	Interrupt response time.....	259
A.3.4.1	Overview: Interrupt response time.....	259
A.3.4.2	Reproducibility of Time-Delay and Watchdog Interrupts.....	260
A.4	Additional documentation.....	261
	<b>Glossary.....</b>	<b>263</b>
	<b>Index.....</b>	<b>295</b>



## 1.1 Function of the IM 151-8 PN/DP CPU interface module

The IM 151-8 PN/DP CPU interface module is a component of the ET 200S distributed I/O system with degree of protection IP20. The IM 151-8 PN/DP CPU interface module is an "intelligent preprocessor". It enables you to decentralize control tasks.

Therefore, an ET 200S with IM 151-8 PN/DP CPU can exercise full and, if necessary, independent control over a process-related functional unit.

- Functions of the IM151-8 PN/DP CPU on PROFINET:
  - IO controller
  - I-Device
  - I device and IO controller
  - PROFINET CBA device with or without proxy functionality for PROFIBUS DP (for proxy functionality for PROFIBUS DP, the DP master module must additionally be plugged in)
- Functions of the IM151-8 PN/DP CPU on PROFIBUS DP:
  - DP master together with the optional DP master module

The use of the IM 151-8 PN/DP CPU interface module leads to further modularization and standardization of process-related functional units and simple, clear machine concepts.

## 1.2 Properties of the IM 151-8 PN/DP CPU interface module

### Properties of the IM 151-8 PN/DP CPU interface module

The IM 151-8 PN/DP CPU interface module has the following special features:

- The interface module has PLC functionality (integrated CPU component with 192 kB work memory).
- The interface module can only be used with the load memory inserted (SIMATIC Micro Memory Card).
- The interface module can be enhanced with up to 63 I/O modules from the ET 200S range.
- The maximum bus length is 2 m.
- Connection to PROFINET via a PROFINET interface with integrated switch and 3 RJ45 ports.
  - The IP address for PROFINET can be saved, for example, on the SIMATIC Micro Memory Card during the hardware configuration but can also be assigned by the user program (SFB 104) or assigned externally via DCP (for instance, using the Setup Tool or even by a higher level IO controller).
  - Ports 1 and 2 can also be used as ring ports for the creation of redundant ring structures on the Ethernet (media redundancy)
  - Communication is established via PROFINET, for which PROFINET IO is supported as an IO controller (to which up to 128 IO devices can be connected) and / or and I device or PROFINET CBA.
  - The PROFINET interface allows both PD/OP communication and other types of communication, such as open communication and S7 communication.
- As a PROFINET IO controller, the IM 151-8 PN/DP CPU interface module also supports
  - the real-time communication via RT and IRT
  - the prioritized start-ups of PROFINET IO devices
  - the replacement of devices without exchangeable medium/PD
  - the exchange of IO devices during operation (changing partner ports)
  - Isochronous mode on PROFINET
  - Shared Device.
- The IM151-8 PN/DP CPU interface module can also be used as an I device at the PROFINET IO. It can then exchange data with a higher level controller and thus be used as an intelligent pre-processing unit for subprocesses.
  - An IM151-8 PN/DP interface module used as an I device can at the same time function as an IO controller and thus power a lower level PROFINET IO subnet of its own.
  - An IM151-8 PN/DP interface module used as an I device can also be used as a shared I device.
  - When used as an I device, I/O transfer areas can be configured which allow a higher level IO controller to access an IM151-8 PN/DP interface module directly via the local I/O.



- Down times are minimized thanks to the integrated diagnostics.
- It is possible to update the firmware via SIMATIC Micro Memory Card or online via the network.
- An integrated web server for user-defined web pages, information, status and diagnostics provides the respective data to any location.
- The interface module has a mode selector with positions for RUN, STOP and MRES.
- There are 10 LEDs on the front of the interface module to indicate the following:
  - ET 200S faults (SF)
  - bus faults on PROFINET (BF-PN)
  - available maintenance information (MT)
  - Supply voltage for electronic components (ON)
  - Force requests (FRCE)
  - operating mode of the IM 151-8 PN/DP CPU interface module (RUN and STOP)
  - Connection status at ports 1 and 3 of the PROFINET interface (P1 - LINK, P2 - LINK, P3 - LINK)
- The IM 151-8 PN/DP CPU interface module can be expanded by **one** DP master module. This also lends it the functionality of a DP master.

### Integration of the IM 151-8 PN/DP CPU interface module in ET 200S

The IM 151-8 PN/DP CPU interface module is integrated in ET 200S just like any other module; i. e. same configuration concept, installation and expansion capability. Information on this can be found in the *ET 200S distributed I/O system* Operating Instructions.

### How do I configure and program the ET 200S with IM 151-8 PN/DP CPU ?

To configure an ET 200S with IM 151-8 PN/DP CPU (configuration and parameter assignment) and to program the IM 151-8 PN/DP CPU interface module you will need the *STEP 7* project design software, V5.5 or later. The procedure for configuring the ET 200S with IM 151-8 PN/DP CPU is described in the Commissioning (<http://support.automation.siemens.com/WW/view/en/31977679>) section of these Operating Instructions. In the *S7-300 Instruction List* you will find the *STEP 7* instruction set for programming the IM151-8 PN/DP CPU interface module. The instruction list is available as a download from the Internet (<http://support.automation.siemens.com/WW/view/en/31977679>).

**Constraints on using motor starters and ET 200S modules**

With central use in an ET 200S with IM 151-8 PN/DP CPU the following motor starters and ET 200S modules can cause disturbing responses. The product versions specified of these motor starters and ET 200S modules should **not** be used in an ET 200S with IM 151-8 PN/DP CPU.

Table 1- 1 Constraints on using motor starters and ET 200S modules

Motor starter / module	Order number	Up to and including product version
DS1e-x direct-on-line starter; HF	3RK1301-0□B10-□AA2	E06
RS1e-x reversing starters; HF		
F-DS1e-x fail-safe direct starters; HF	3RK1301-0□B13-□AA2	E06
F-RS1e-x fail-safe reversing starters; HF		
DS1e-x direct-on-line starter; HF	3RK1301-0□B□0-□AA3	E03
RS1e-x reversing starters; HF		
DSS1e-x direct soft starters; HF		
DS1e-x direct-on-line starter; HF	3RK1301-0□B□□-□AA4	E02
RS1e-x reversing starters; HF		
DSS1e-x direct soft starters; HF		
F-DS1e-x fail-safe direct starters; HF		
F-RS1e-x fail-safe reversing starters; HF		
2AI I 2WIRE HS analog electronic module	6ES7134-4GB52-0AB0	E03
2 AI I 4WIRE HS analog electronic module	6ES7134-4GB62-0AB0	E01
Analog electronic module 2AI U HS	6ES7134-4FB52-0AB0	E01
2AO I HS analog electronic module	6ES7135-4GB52-0AB0	E01
2AO U HS analog electronic module	6ES7135-4FB52-0AB0	E03

## 1.3 Properties of the DP master module

Together with the DP master module you can operate the IM 151-8 PN/DP CPU interface module as a DP master.

---

### Note

The IM 151-8 PN/DP CPU interface module can be expanded by no more than **one** DP master module.

---

### Properties of the DP master module

The DP master module has the following special features:

- The PROFIBUS DP address is saved alongside the HW Config configuration on the SIMATIC Micro Memory Card in the IM 151-8 PN/DP CPU interface module.
- There is 1 LED on the front of the DP master module to indicate bus faults on the PROFIBUS DP (BF).
- Connection to PROFIBUS DP via the DP interface (RS 485) on the DP master module

### Integration of the DP master module in ET 200S

The DP master module is connected to the IM 151-8 PN/DP CPU from the right and hence integrated in the ET 200S.

### How do I configure and program the ET 200S with IM 151-8 PN/DP CPU and master module?

To configure an ET 200S with IM 151-8 PN/DP CPU and DP master module (configuration and parameter assignment) and to program the IM 151-8 PN/DP CPU interface module you will need the *STEP 7* project design software, V5.5 or later.

The procedure for configuring the ET 200S with IM 151-8 PN/DP CPU and DP master module is described in the Commissioning (Page 172) section of these Operating Instructions.

## 1.4 Example configurations

### Example configuration of an ET 200S with IM 151-8 PN/DP CPU

The figure below shows an example configuration of an ET 200S with IM 151-8 PN/DP CPU.

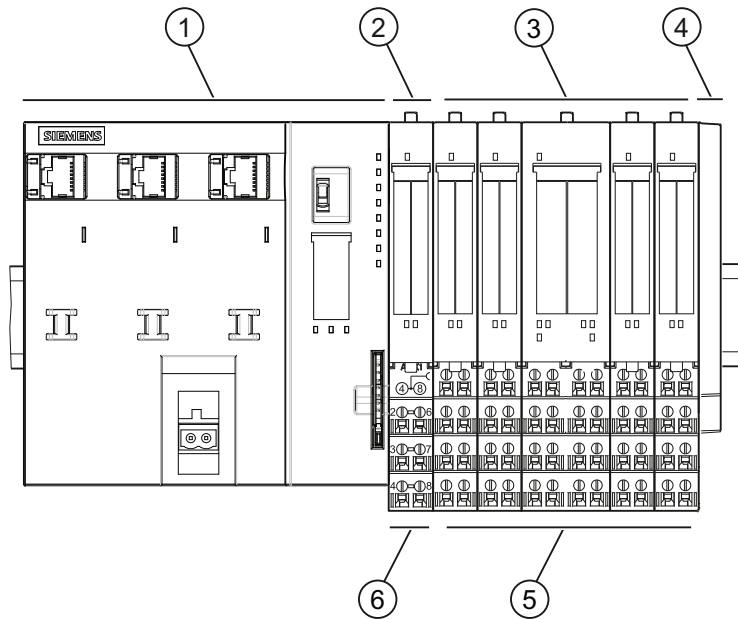

Figure 1-1 View of the ET 200S distributed I/O system with IM 151-8 PN/DP CPU

- |                                            |                                                |
|--------------------------------------------|------------------------------------------------|
| ① IM 151-8 PN/DP CPU interface module      | ④ Terminating module                           |
| ② PM-E power module for electronic modules | ⑤ TM-E terminal modules for electronic modules |
| ③ Electronic modules                       | ⑥ TM-P terminal modules for PM-E power modules |

### Example configuration of an ET 200S with IM 151-8 PN/DP CPU and DP master module

The figure below shows an example configuration of an ET 200S with IM 151-8 PN/DP CPU and DP master module.

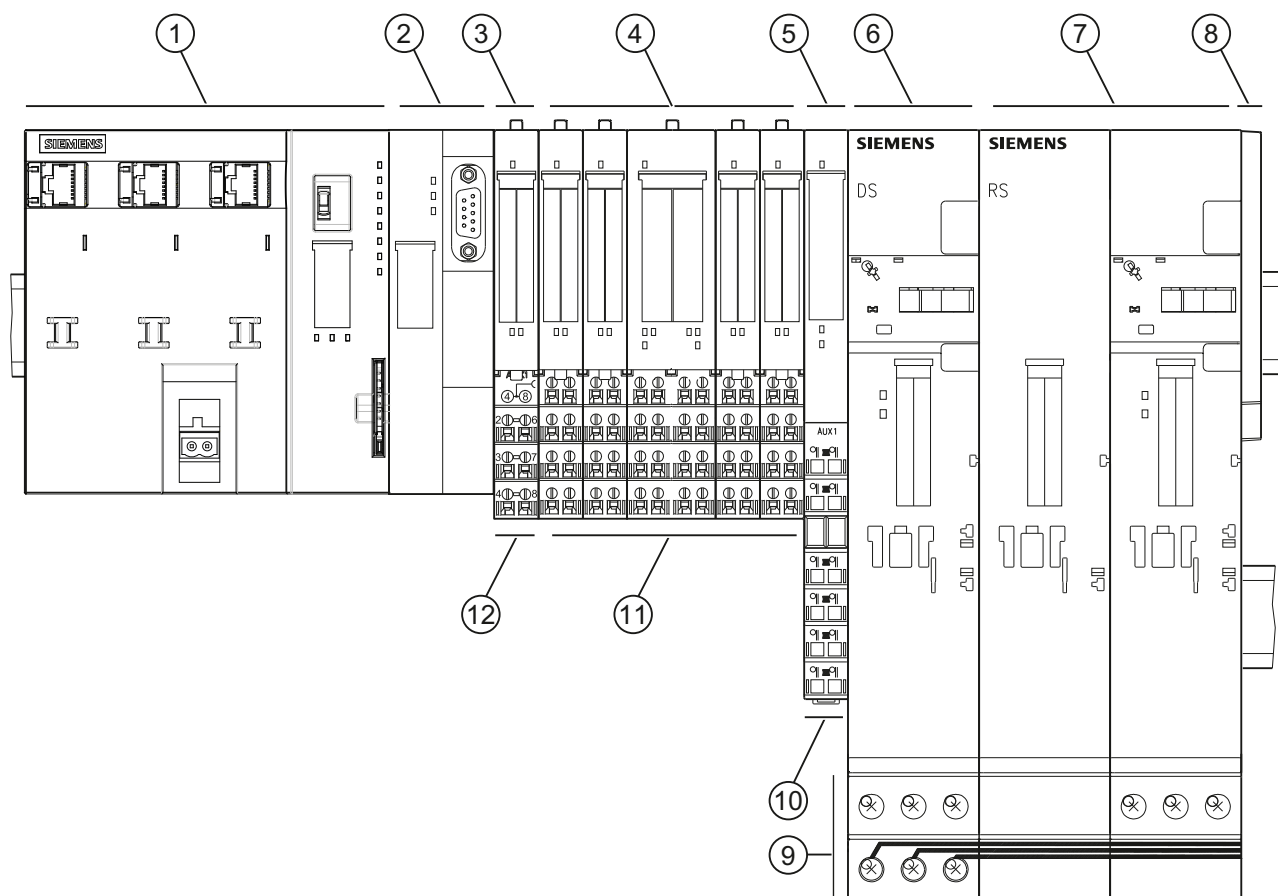

Figure 1-2 View of the ET 200S distributed I/O system with IM 151-8 PN/DP CPU and DP master module

- |                                            |                                                |
|--------------------------------------------|------------------------------------------------|
| ① IM 151-8 PN/DP CPU interface module      | ⑦ Reversing starter                            |
| ② DP master module                         | ⑧ Terminating module                           |
| ③ PM-E power module for electronic modules | ⑨ Power bus                                    |
| ④ Electronic modules                       | ⑩ TM-P terminal module for PM-D power modules  |
| ⑤ PM-D power module for motor starters     | ⑪ TM-E terminal modules for electronic modules |
| ⑥ Direct starters                          | ⑫ TM-P terminal modules for PM-E power modules |

*Description*

---

*1.4 Example configurations*

## Operating and display elements

### 2.1 Operating and display elements of the IM 151-8 PN/DP CPU interface module

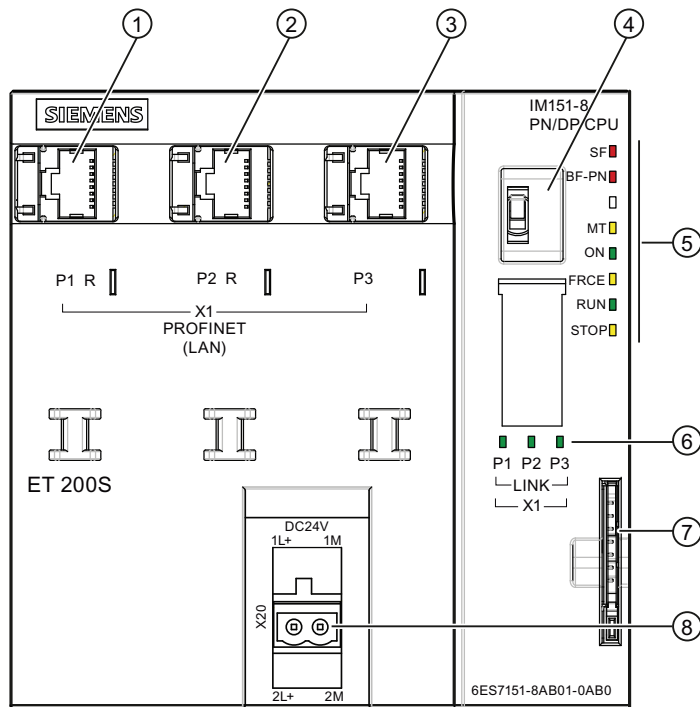

Number	Designation
①	RJ45 socket (port 1 of the PROFINET interface) R: Ring port for creation of ring topology with media redundancy
②	RJ45 socket (port 2 of the PROFINET interface) R: Ring port for creation of ring topology with media redundancy
③	RJ45 socket (port 3 of the PROFINET interface)
④	Mode selector switch
⑤	Status and error displays of the IM 151-8 PN/DP CPU interface module
⑥	Status displays of the PROFINET interface
⑦	Slot for the SIMATIC Micro Memory Card
⑧	Connection for supply voltage

### Slot for the SIMATIC Micro Memory Card

Memory module is a SIMATIC Micro Memory Card. You can use MMCs as load memory and as portable storage media. The slot for the SIMATIC Micro Memory Card can be accessed from the front of the interface module. The *Inserting/Replacing a Micro Memory Card* section contains detailed information on inserting the SIMATIC Micro Memory Card.

---

#### Note

The IM151-8 PN/DP CPU interface module does not have an integrated load memory, so you will need to connect a SIMATIC Micro Memory Card to the IM 151-8 PN/DP interface module in order to use it.

---

### Mode selector switch

You can use the mode selector switch to set the current operating mode of the IM 151-8 PN/DP CPU .

Table 2- 1 Mode selector switch settings

Position	Meaning	Description
RUN	RUN mode	The IM 151-8 PN/DP CPU interface module processes the user program.
STOP	STOP mode	The IM 151-8 PN/DP CPU interface module does not process the user program.
MRES	Memory reset	Mode selector switch setting for <ul style="list-style-type: none"><li>• Memory reset of the IM 151-8 PN/DP CPU interface module</li><li>• Backing up the firmware to the SIMATIC Micro Memory Card</li><li>• Resetting to the as-supplied state</li></ul> A memory reset using the mode selector requires a number of steps to be carried out in a set order.

### Reference

- Operating modes of the IM 151-8 PN/DP CPU interface module: *STEP 7 Online Help*.
- Information on performing a memory reset of the IM 151-8 PN/DP CPU interface module: Section *Resetting the IM 151-8 PN/DP CPU interface module using the mode selector switch*)
- Evaluation of the LEDs for errors or diagnostics: See the *Diagnostics using status and error LEDs* section.

### See also

Inserting/Replacing a SIMATIC Micro Memory Card (Page 148)



## 2.2 Status and error displays of the IM 151-8 PN/DP CPU interface module

### General status and error displays

Table 2- 2 General status and error displays of the IM 151-8 PN/DP CPU interface module

LED designation	Color	Meaning
SF	Red	Group fault for hardware or software error
MT	Yellow	Maintenance information
ON	Green	Supply voltage for the IM 151-8 PN/DP CPU
FRCE	Yellow	LED is lit: Active force job LED flashes at 2 Hz: Node flash test function.
RUN	Green	IM 151-8 PN/DP CPU in RUN The LED flashes during STARTUP at a rate of 2 Hz, and in HOLD state at 0.5 Hz.
STOP	Yellow	IM 151-8 PN/DP CPU in STOP or in HOLD or STARTUP The LED flashes at 0.5 Hz when the CPU requests a memory reset, and during the reset at 2 Hz.

### Status and error displays for the bus interfaces

Table 2- 3 Status and error displays for the bus interfaces of the IM 151-8 PN/DP CPU interface module

LED designation	Color	Meaning
BF-PN	Red	Bus fault on the PROFINET
P1 - LINK	Green	Connection at port 1 is active
P2 - LINK	Green	Connection at port 2 is active
P3 - LINK	Green	Connection at port 3 is active

### Reference

- Operating modes of the IM 151-8 PN/DP CPU interface module: *STEP 7 Online Help*
- Information on performing a memory reset of the IM 151-8 PN/DP CPU interface module: Section *Resetting the IM 151-8 PN/DP CPU interface module using the mode selector switch*)
- Evaluation of the LEDs for errors or diagnostics: See the *Diagnostics using status and error LEDs* section

## 2.3 Display elements of the DP master module

### Display elements

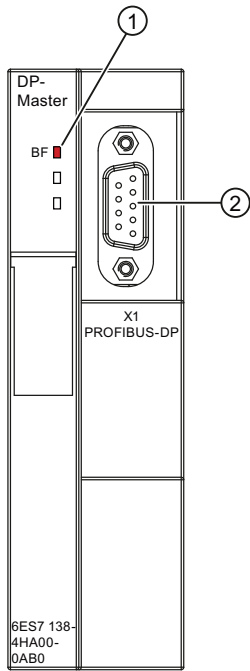

Figure 2-1 Display elements of the DP master module

The figure shows ...	the following elements of the DP master module
①	Status and error displays
②	9-pin sub D socket for PROFIBUS DP

# Communication

## 3.1 Interfaces

### 3.1.1 PROFINET (PN)

#### Availability

The IM151-8 PN/DP CPU interface module has a PROFINET interface with integral switch and 3 ports (RJ45 sockets).

- At these ports, the network can be configured with a line structure with no additional external switch.
- When ports 1 and 2 are designated as ring ports (P1 R, P2 R), they can be used to create a redundant ring topology.
- You can also connect an additional PROFINET device, such as a PD for commissioning or an OP for operation and monitoring.

#### Connecting to Industrial Ethernet

You can use the integrated PROFINET interface of the IM 151-8 PN/DP CPU interface module to establish a connection to Industrial Ethernet.

The integrated PROFINET interface of the IM 151-8 PN/DP CPU interface module is configured via the PROFINET interface.

#### Time Synchronization using PROFINET

The IM 151-8 PN/DP CPU interface module can be used as a time client at the PROFINET interface by using the NTP method. This is set in HW Config. The default setting is no time synchronization.

As the time client, the IM 151-8 PN/DP CPU receives synchronization message frames from a time NTP server (e.g. SICLOCK TS) and accepts this time as its own internal time.

In addition to time synchronization at the PROFINET interface, there is also time synchronization at the DP interface of the DP master module. The IM 151-8 PN/DP CPU interface module can be the time slave on only one of these interfaces.

At the PN interface, there is **only** the functionality as a time client (functionality is the same as that of a time slave at the DP interface).

**Example:** The IM 151-8 PN/DP CPU interface module is synchronized by a time server over NTP via the PN interface (corresponding to the functionality as a time slave). The IM 151-8 PN/DP CPU interface module can then only be used as a time master at the DP interface.

**Devices capable of PROFINET (PN) communication**

- PROFINET IO controller
- PROFINET IO devices (for example, interface module IM 151-3 PN in an ET 200S)
- PROFINET CBA components
- S7-300 / S7-400 with PROFINET interface (for example, CPU 317-2 PN/DP or CP 343-1)
- Active network components (a switch, for example)
- IE/PB link
- Programming device / PC with network card

**Properties of the PROFINET interface**

Properties	
IEEE standard	802.3
Connector design	
• Ports 1 to 3	RJ45
Transmission speed	Up to 100 Mbps
Media	Twisted pair Cat5 (100 BASE-TX)
Media redundancy	to IEC 61158

---

**Note**

**Networking PROFINET components**

The use of switches, rather than hubs, for networking PROFINET components brings about a substantial improvement in decoupling bus traffic, and improves runtime performance under higher bus load. PROFINET CBA with cyclic PROFINET interconnections requires the use of switches in order to maintain compliance with performance specifications. Full duplex mode at 100 Mbps is mandatory for cyclic PROFINET interconnections.

PROFINET IO also requires the use of switches and 100 Mbps full duplex mode.

For PROFINET IO in IRT mode (Isochronous Real Time) all PROFINET devices in the sync domain must be IRT-capable, even the switches.

---

### Configuring the port properties of the PROFINET interface in *STEP 7*

The PROFINET interfaces in our devices are preset to a default "automatic setting" (Autonegotiation). Ensure that all devices connected to the PROFINET interface of the IM 151-8 PN/DP CPU interface module are also set to the "Autonegotiation" operating mode. This is the default setting of standard PROFINET / Ethernet components.

If you connect a device to the PROFINET interface of the IM 151-8 PN/DP CPU interface module that does not support the "automatic setting" (Autonegotiation) operating mode, or if you select a setting other than the "automatic setting" (Autonegotiation), note the following:

- PROFINET IO and PROFINET CBA require operation with 100 Mbps full-duplex, i.e. when the PROFINET interface of the IM 151-8 PN/DP CPU interface module for PROFINET IO / CBA communication and Ethernet communication is used at the same time, the PROFINET interface can only be operated with 100 Mbps full-duplex.
- If the PROFINET interface of the IM 151-8 PN/DP CPU interface module is used only for Ethernet communication, alongside the "automatic setting" (Autonegotiation) 100 Mbps full-duplex or 10 Mbps full-duplex operating modes can be used. Half-duplex mode is not allowed in any situation.

Reason: If, for example, a switch permanently set to "10 Mbps half-duplex" is connected to the PROFINET interface of the IM 151-8 PN/DP CPU interface module, due to the "Autonegotiation" setting the IM 151-8 PN/DP CPU interface module forwards this setting to the partner device - i.e. the communication operates de facto with "10 Mbps half-duplex". However, since PROFINET IO and PROFINET CBA require operation with 100 Mbps full-duplex, this operating mode is not allowed.

---

#### Note

To configure the ports of IO devices which are to perform a prioritized start-up refer to the special information under *PROFINET System Description*.

---

### Disabling a port of the PROFINET interface with IM 151-8 PN/DP CPU

In *STEP 7* HW Config you can disable a port of the PROFINET interface of an IM 151-8 PN/DP CPU interface module. This is enabled as default.

The IM 151-8 PN/DP CPU interface module cannot be reached via a disabled port in the PROFINET interface.

Note that it is not possible to perform communication functions, like for example, PD / OP functions, open IE communications or S7 communication, via a disabled port.

---

#### Note

In the case of an IM 151-8 PN/DP CPU interface module one port must always be enabled so that access to the module is always guaranteed.

---

### Addressing the ports

To diagnose the individual ports of a PROFINET interface, these ports must each have a separate diagnostics address. The addressing is done in HW Config. For further information, refer to the *PROFINET System Description*.

The diagnostic message (fault and maintenance information) can be enabled using OB 82 (enable in HW Config) and then analyzed using SFB 54, for example, in order to diagnose any problems identified in the user program. There are also various data records (read using SFB 52) and system status lists (read using SFC 51) provided for more detailed diagnostics.

Diagnostics is also possible in *STEP 7* (e.g. communication diagnostics, network connection, Ethernet statistics, IP parameters).

### Send clock and send cycle

Controllers and devices with a standardized send clock can be used in a PROFINET IO subnet. For devices that do not support a faster controller send clock, the send clock is adapted to the capabilities of the device. That is, you could operate devices both at a send clock of 250 µs and 1 ms on a IM151-8 PN/DP CPU interface module (IO controller) which operates at a send clock of 250 µs.

The device send cycle can be set within a relatively large range. This, in turn, depends on the send clock. The following update times can be configured when using the IM151-8 PN/DP CPU interface module:

Real-time communication	Send clock	Update Time
For RT:	250 µs	⇒ 250 µs to 128 ms
	500 µs	⇒ 500 µs to 256 ms
	1 ms	⇒ 1 ms to 512 ms
	2 ms	⇒ 2 ms to 512 ms
	4 ms	⇒ 4 ms to 512 ms
For IRT with the "high flexibility" option:	250 µs	⇒ 250 µs to 128 ms
	500 µs	⇒ 500 µs to 256 ms
	1 ms	⇒ 1 ms to 512 ms
For IRT with the "high performance" option:	250 µs	⇒ 250 µs to 4 ms
	500 µs	⇒ 500 µs to 8 ms
	1 ms	⇒ 1 ms to 16 ms
	2 ms	⇒ 2 ms to 32 ms
	4 ms	⇒ 4 ms to 64 ms

The minimum send cycle depends on the number of devices in use, the amount of configured user data and the communication portion for PROFINET IO. *STEP 7* automatically considers these dependencies during configuration.

### Non-whole number send clocks for IRT systems with the "high performance" option:

For IRT systems with the "High Performance" option, as well as the "whole number" send clocks (250  $\mu$ s, 500  $\mu$ s, 1 ms, 2 ms, 4 ms), any number of "non-whole number" send clocks can be set up in multiples of 125  $\mu$ s in the range between 250  $\mu$ s and 4 ms: 375  $\mu$ s, 625  $\mu$ s ... 3.875 ms.

For "non-whole number" send clocks, the rule for all PROFINET IO devices is:

- Update time = send clock
- IRT systems cannot be extended by RT devices into the "High performance" option

#### NOTICE

##### Communication shutdown during memory reset / firmware updates / after POWER OFF on CPUs with integrated switch

Note that the PROFINET interface and integrated switch are shut down during CPU memory reset and firmware updates, or after POWER OFF.

If a CPU is configured for operation in a line topology, communication to the following devices is shut down.

### Reference

- Details of how to configure the integral PROFINET interface of the IM 151-8 PN/DP CPU interface module are given in the *Connecting a PD/PC to the integrated PROFINET interface of the IM 151-8 PN/DP CPU interface module* and *Commissioning PROFINET IO* sections.
- For additional information on PROFINET, refer to PROFINET System Description (<http://support.automation.siemens.com/WW/view/en/19292127>).
- For more information on Ethernet networks, network configuration and network components, refer to the SIMATIC NET twisted pair and fiber optic networks (<http://support.automation.siemens.com/WW/view/en/8763736>) manual:
- Commissioning Component Based Automation Systems (<http://support.automation.siemens.com/WW/view/en/18403908>)
- Additional information about PROFINET can be found on the Internet (<http://www.profinet.com>).

### See also

Connecting a programming device / PC to the integrated PROFINET interface of the IM 151-8 PN/DP CPU interface module (Page 158)

Configuring and commissioning the PROFINET IO system (Page 173)

### 3.1.2 PROFIBUS DP

#### Availability

Together with the optional DP master module, the IM 151-8 PN/DP CPU interface module has an RS 485 interface with DP master functionality.

#### Properties

The PROFIBUS DP interface on the DP master module is mainly used to connect distributed I/O. PROFIBUS DP allows you to create large subnets, for example.

You can configure the PROFIBUS DP interface as master or to be inactive. It allows a transmission rate of up to 12 Mbps.

The IM 151-8 PN/DP CPU broadcasts its bus parameters (such as the baud rate) to the PROFIBUS DP interface when it is used as the master. A programming device, for example, can thus receive the correct parameters and automatically connect to a PROFIBUS subnet. In your configuration you can specify to disable bus parameter broadcasting.

#### Time synchronization using PROFIBUS

Time synchronization is possible via the DP interface on the DP master module of the IM 151-8 PN/DP CPU interface module. The IM 151-8 PN/DP CPU may act as the time master (with suitably programmed synchronization interval) or time slave. This is set in HW Config. The default setting is no time synchronization.

As the time master, the IM 151-8 PN/DP CPU interface module sends synchronization message frames to the DP interface at the configured synchronization interval in order to synchronize other stations on the connected PROFIBUS DP subnet.

If the IM151-8 PN/DP CPU interface module is configured on the DP interface as time master, then there will be no time synchronization of the connection time slaves, as the clock of the IM 151-8 PN/DP CPU interface module is still set to default.

Note that the clock of the IM151-8 PN/DP CPU interface module is not yet set when it ships, after a reset to factory setting by means of the mode selector switch or after a firmware update.

As soon as the time of day is set the first time, the time synchronization starts as the time master by means of:

- PD function
- SFC call or
- a different time master (if the IM 151-8 PN/DP CPU interface module has also be configured as a time client by the PROFINET interface).

As the time slave, the IM 151-8 PN/DP CPU interface module receives synchronization message frames from a different time master and accepts this time as its own internal time.

In addition to time synchronization at the DP interface of the DP master module, there is also time synchronization at the PROFINET interface. The IM 151-8 PN/DP CPU interface module can be the time slave on only one of these interfaces. At the PN interface, it can only act as a time client (functionality is the same as that of a time slave at the DP interface).

**Example:** The IM 151-8 PN/DP CPU interface module is time synchronized by a time server over NTP via the PN interface. The IM 151-8 PN/DP CPU interface module can then only be used as a time master at the DP interface.



### Devices capable of PROFIBUS DP communication

- Programming device / PC
- OP/TP
- DP slaves
- Actuators/Sensors
- S7-300/S7-400 with PROFIBUS DP interface

### Reference

Additional information on PROFIBUS: " PROFIBUS (<http://www.profibus.com>)"

## 3.2 Communication services

### 3.2.1 Overview of communication services

#### Selecting the communication service

You need to decide on a communication service, based on functionality requirements. Your choice of communication service will have no effect on:

- The functionality available
- Whether an S7 connection is required or not
- The time of connecting

The user interface can vary considerably (SFC, SFB, ...), and is also determined by the hardware used (IM 151-8 PN/DP CPU, PC, ...).

#### Overview of communication services

The table below provides an overview of the communication services provided by the IM 151-8 PN/DP CPU interface module.

Table 3- 1 Communication services of the IM 151-8 PN/DP CPU interface module

Communication service	Functionality	Time at which the S7 connection is established ...	via PN	via DP (optional)
Programming device communication	Commissioning, test, diagnostics	From the programming device, starting when the service is used	X	X
OP communication	Control and monitoring	From the OP at Power ON	X	X
S7 communication	Data exchange in server and client mode: Configuration of communication required	from the active partner at power on.	X	Only in server mode
Global data communication	Cyclic data exchange (for example, bit memory)	Does not require an S7 connection	–	–

3.2 Communication services

Communication service	Functionality	Time at which the S7 connection is established ...	via PN	via DP (optional)
Routing programming device functions	for example testing, diagnostics on other networks also	From the programming device, starting when the service is used	X	X
Data set routing	e.g. configuration and diagnostics of field devices on PROFIBUS DP, if the PD with the associated configuration tool (e.g. PDM) is not connection to the same PROFIBUS DP subnet as that of the field device, but, for example, on the PROFINET subnet at which the PN interface of the IM 151-8 PN/DP CPU interface module is also connected.	from the PD, starting when the service is being used	X	X
PROFIBUS DP	Data exchange between master and slave	Does not require an S7 connection	–	X only as DP master
PROFINET CBA	Data exchange by means of component based communication	Does not require an S7 connection	X	–
PROFINET IO	Data exchange between IO controllers and the IO devices	Does not require an S7 connection	X	–
Web server	Diagnostics	Does not require an S7 connection	X	–
SNMP (Simple Network Management Protocol)	Standard protocol for network diagnostics and configuration	Does not require an S7 connection	X	–
Open communication by means of TCP/IP	Data exchange via Industrial Ethernet with TCP/IP protocol (by means of loadable FBs)	Does not require an S7 connection, is handled in the user program by means of loadable FBs	X	–
Open communication by means of ISO on TCP	Data exchange via Industrial Ethernet with ISO-on-TCP protocol (by means of loadable FBs)	Does not require an S7 connection, is handled in the user program by means of loadable FBs	X	–
Open communication by means of UDP	Data exchange via Industrial Ethernet with UDP protocol (by means of loadable FBs)	Does not require an S7 connection, is handled in the user program by means of loadable FBs	X	–
Time synchronization	Broadcast telegrams	Does not require an S7 connection	–	X
Time synchronization	NTP protocol	Does not require an S7 connection	X	–

See also

Distribution and availability of S7 connection resources (Page 47)

Connection resources for routing (Page 48)

## 3.2.2 PG communication

### Properties

Programming device communication is used to exchange data between engineering stations (programming device, PC, for example) and SIMATIC modules which are capable of communication. This service is available via PROFIBUS and Industrial Ethernet subnets. Transition between subnets is also supported.

Programming device communication provides the functions needed to download / upload programs and configuration data, to run tests and to evaluate diagnostic information. These functions are integrated in the operating system of the IM 151-8 PN/DP CPU interface module.

An IM 151-8 PN/DP CPU interface module can maintain several simultaneous online connections to one or multiple programming devices.

### IM 151-8 PN/DP CPU without configured PROFINET interface

If your IM 151-8 PN/DP CPU interface module still does not have a configured PROFINET interface (IP address), you can nevertheless communication from the PD with the IM 151-8 PN/DP CPU interface module.

- The IM 151-8 PN/DP CPU interface module logs on to the SIMATIC Manager with its MAC address via "Available nodes".

If the Ethernet interface of the PD is set to "TCP/IP (Auto)", then during the first establishment of a communication connection (e.g. call of the module status or the online table of contents of the CPU), a temporary IP address is automatically assigned by the PD to the PG interface of the IM 151-8 PN/DP CPU interface module. This is then maintained until the next power off / power on or memory reset, or until a HW configuration with a differing (retentive) IP address is loaded.

- Whilst downloading the parameters of the HW Config, the correct IP address can be allocated to IM 151-8 PN/DP CPU interface module during the loading process. The procedure for this can be found in section *Connecting a PD / PC to the integrated PROFINET interface of the an IM151-8 PN/DP CPU interface module*.
- An IP address can be assigned to a PN interface in the SIMATIC manager under "Target system > Edit Ethernet node". From V3.2 onward, this remains permanently stored.

### 3.2.3 OP communication

#### Properties

OP communication is used to exchange data between operator CPUs (OP, TP, WinCC, for example) and SIMATIC modules which are capable of communication. This service is available via PROFIBUS and Industrial Ethernet subnets.

OP communication provides functions you require for monitoring and modifying. These functions are integrated in the operating system of the IM 151-8 PN/DP CPU interface module.

An IM 151-8 PN/DP CPU interface module can maintain several simultaneous online connections to one or different OPs.

It is only after the PN interface of the IM 151-8 PN/DP CPU interface module has been operated with a configured IP address that an OP be run on the interface.

### 3.2.4 S7 communication

#### Properties

The IM 151-8 PN/DP CPU interface module can act as either a server or a client in S7 communication. A distinction is made between:

- Communication with unilateral configuration (for PUT/GET only)
- Communication with bilateral configuration (for USEND, URCV, BSEND, BRCV, PUT, GET)

The available functionality is described in the following table.

Table 3-2 client and server in S7 communication, using connections with unilateral / bilateral configuration

Interface module	Use in server mode for connections with unilateral configuration	Use in server mode for connections with bilateral configuration	Use as client
IM 151-8 PN/DP CPU	Usually possible at the DP/PN interface without programming the user interface	Possible at the PN interface with loadable FBs	Possible at the PN interface with loadable FBs

The user interface is implemented using standard function blocks (FBs) under communication blocks in the standard *STEP 7* library.

#### Reference

For additional information on communication, refer to the *Communication with SIMATIC* manual.

### 3.2.5 Routing

#### Properties

Using *STEP 7* you can use the PD / PC via your IM 151-8 PN/DP CPU interface module (with DP master module) to reach a CPU in a different subnet, in order, for example, to

- download user programs
- download a hardware configuration or
- perform tests and diagnostics functions.

#### Routing network nodes: PROFINET - PROFIBUS

Gateways between subnets are routed in a SIMATIC station that is equipped with interfaces to the respective subnets. The figure below shows the access from PROFINET to PROFIBUS. The CPU 1 (IM 151-8 PN/DP CPU with DP master module) is the router between subnet 1 and subnet 2.

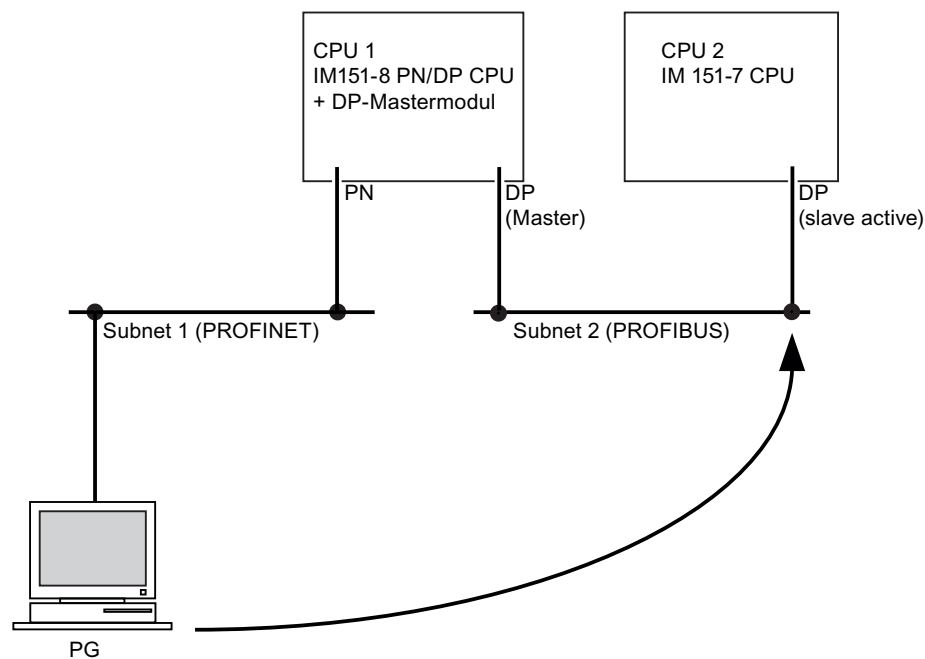

#### Number of connections for routing

A maximum of 4 connections are available on the PROFINET interface of the IM 151-8 PN/DP CPU interface module for the routing function.

## Requirements

- The station modules are "capable of routing" (CPUs or CPs).
- The network configuration does not exceed project limits.
- The modules have loaded the configuration data containing the latest "knowledge" of the entire network configuration of the project.

Reason: All modules participating in the network transition must receive the routing information defining the paths to other subnets.

- In your network configuration, the programming device/PC you want to use to establish a connection via network node must be assigned to the network it is physically connected to.

## Reference

Additional information

- About configuring with *STEP 7* can be found in the *Configuring Hardware and Connections in STEP 7* manual
- On communication are found in the *Communication with SIMATIC* Manual.
- On SFCs, refer to the *S7-300 Instruction List*.  
A detailed description is given in the *STEP 7 Online Help* or *System and Standard Functions for S7-300/400* Reference Manual.

### 3.2.6 Data set routing

#### Availability

The IM 151-8 PN/DP CPU interface module supports data set routing if a DP master module is connected to it.

#### Routing and data set routing

Routing is the transfer of data beyond network boundaries. You can send information from a transmitter to a receiver across several networks.

Data record routing is an expansion of the "standard routing" and is used, for example, by *SIMATIC PDM*. The data sent through data set routing includes the parameters for the participating field devices (slaves) as well as device-specific information (e.g. setpoint values, limit values, etc.). The structure of the target address for data record routing depends on the data contents, i.e. the slave to which the data is to be sent.

With the PD, e.g. a parameter set that already exists on the field device can be read, edited and then sent back to the field device if the PD is not connected to the same PROFIBUS DP subnet as that of the field device.

The field devices themselves do not have to support data set routing, since they do not forward the information received.

## Data set routing

The following figure shows the access of the PD to a variety of field devices. In doing so, the PD is connected via PROFINET to the IM 151-8 PN/DP CPU interface module. The IM 151-8 PN/DP CPU interface module communicates via PROFIBUS with the field devices.

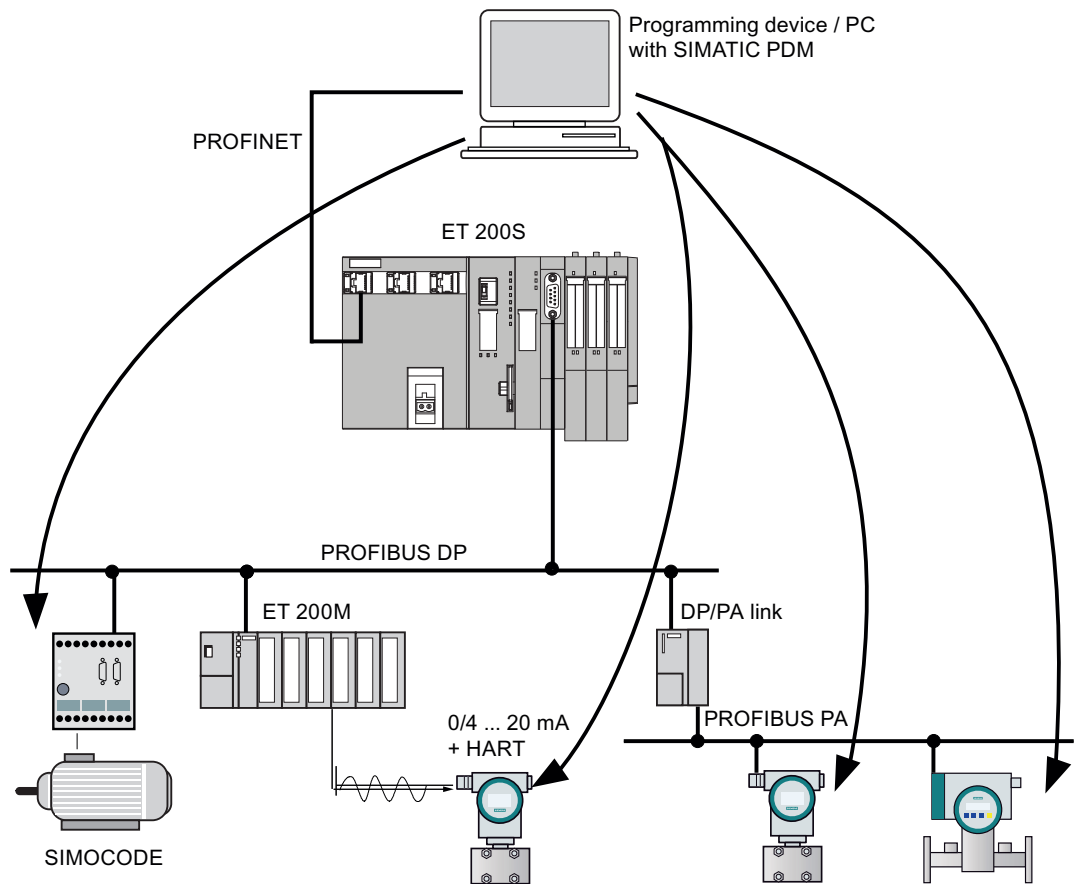

Figure 3-1 IM 151-8 PN/DP CPU data set routing

## See also

You can find additional information on *SIMATIC PDM* in the *The Process Device Manager Manual*.

### 3.2.7 Data consistency

#### Properties

A data area is consistent if it can be read or written to from the operating system as a consistent block. Data exchanged collectively between the stations should belong together and originate from a single processing cycle, that is, be consistent. If the user program contains a programmed communication function, for example, FB 12 "BSEND" / FB 13 "BRCV", which accesses shared data, access to that data area can be coordinated by means of the "BUSY" parameter itself.

#### With PUT/GET functions

For S7 communication functions, such as PUT / GET or write / read via OP communication, which do not require a block in the user program on the IM151-8 PN/DP CPU interface module (acting as a server), allowances must be made in the programming for the extent of the data consistency. The PUT / GET functions for S7 communication, or for read / write variables via OP communication, are executed at the IM151-8 PN/DP CPU interface module's cycle control point. In order to ensure a defined process interrupt reaction time, communication variables are copied consistently in blocks of up to 240 bytes to/from the user memory at the operating system's cycle control point. Data consistency is not guaranteed for larger data areas.

---

#### Note

If defined data consistency is required, the length of the communication variables in the IM151-8 PN/DP CPU interface module operating system's user program must not exceed 240 bytes.

---

## 3.3 SNMP communication service

#### Availability

The SNMP communication service is available for the IM 151-8 PN/DP CPU interface module with integrated PROFINET interface.

#### Properties

SNMP (Simple Network Management Protocol) is a standard protocol for TCP/IP networks.

#### Reference

For additional information on the SNMP communication service and diagnostics with SNMP, refer to the *PROFINET System Description*.



## 3.4 Open communication via Industrial Ethernet

### Requirement

- STEP 7 V5.4 + Servicepack 4 or higher

### Functionality

The IM 151-8 PN/DP CPU interface module with integrated PROFINET interface supports open communication functionality via Industrial Ethernet (abbreviated to *open IE communication*).

The following services are available for open IE communication:

- Connection oriented protocols
  - TCP to RFC 793, connection type B#16#01
  - TCP to RFC 793, connection type B#16#11
  - ISO on TCP to RFC 1006
- Connectionless protocols
  - UDP according to RFC 768

### Features of the communication protocols

The following distinctions are made between protocol types in data communication:

- Connection oriented protocols:

Prior to data transmission these establish a (logical) connection to the communication partner and close this again, if necessary, after transmission is completed. Connection oriented protocols are used when security is especially important in data transmission. A physical cable can generally accommodate several logical connections.

For the FBs to open communication by means of Industrial Ethernet, the following connection oriented protocols are supported:

  - TCP according to RFC 793 (connection types B#16#01 and B#16#11)
  - ISO on TCP according to RFC 1006 (connection type B#16#12)
- Connectionless protocols:

These operate without a connection. There is also no establishing or terminating a connection to remote partner. Wireless protocols transmit data to the remote partner without any acknowledgement; data transfer is, therefore, not secure.

The FBs for open communication over Industrial Ethernet support the following wireless protocol:

  - UDP according to RFC 768 (connection type B#16#13)

### How to use open IE communication

To allow data to be exchanged with other communication partners, *STEP 7* provides the following FBs and UDTs under "Communication Blocks" in the "Standard Library":

- Connection oriented protocols: TCP/ISO-on-TCP
  - FB 63 "TSEND" for sending data
  - FB 64 "TRCV" for receiving data
  - FB 65 "TCON", for connecting
  - FB 66 "TDISCON", for disconnecting
  - UDT 65 "TCON\_PAR" with the data structure for the configuration of the connection
- Connectionless protocol: UDP
  - FB 67 "TUSEND" for sending data
  - FB 68 "TURCV" for receiving data
  - FB 65 "TCON" for establishing the local communication access point
  - FB 66 "TDISCON" for resolving the local communication access point
  - UDT 65 "TCON\_PAR" with the data structure for configuring the local communication access point
  - UDT 66 "TCON\_ADR" with the data structure of the address parameters of the remote partner

### Data blocks for the configuration of the connection

- Data blocks for assigning parameters for TCP and ISO-on-TCP connections

To assign parameters for your connection at TCP and ISO-on-TCP, you need to create a DB that contains the data structure of UDT 65 "TCON\_PAR." This data structure contains all parameters you need to establish the connection. You need to create such a data structure for each connection, and you can also organize it in a global DB.

Connection parameter CONNECT of FB 65 "TCON" reports the address of the corresponding connection description to the user program (for example, P#DB100.DBX0.0 byte 64).
- Data blocks for the configuration the local UDP communication access point

To assign parameters for the local communication access point, create a DB containing the data structure from the UDT 65 "TCON\_PAR" This data structure contains the required parameters you need to establish the connection between the user program and the communication level of the operating system

The CONNECT parameter of the FB 65 "TCON" contains a reference to the address of the corresponding connection description (e.g. P#DB100.DBX0.0 Byte 64).

---

#### Note

##### Setting up the connection description (UDT 65)

You must enter the interface to be used for communication in the "local\_device\_id" parameter in UDT 65 "TCON\_PAR" (e.g. B#16#01: Communication via the integrated PN interface of the IM 151-8 PN/DP CPU interface module).

---

## Establishing a connection for communication

- Use with TCP and ISO-on-TCP

Both communication partners call FB 65 "TCON" to establish the connection. In your connection configuration, you define which communication partner activates the connection, and which communication partner responds to the request with a passive connection. To determine the number of possible connections, refer to your IM 151-8 PN/DP CPU interface module's technical specifications.

The IM 151-8 PN/DP CPU interface module automatically monitors and maintains the established connection.

If the connection is broken, for example by line interruption or by the remote communication partner, the active partner tries to reestablish the connection. You do not have to call FB 65 "TCON" again.

FB 66 "TDISCON" disconnects the IM 151-8 PN/DP CPU interface module from a communication partner, as does STOP mode. To reestablish the connection to have to call FB65 "TCON" again.

- Use with UDP

Both communication partners call FB 65 "TCON" to set up their local communication access point. This establishes a connection between the user program and operating system's communication level. No connection is established to the remote partner.

The local access point is used to send and receive UDP message frames.

## Disconnecting

- Use with TCP and ISO-on-TCP

FB 66 "TDISCON" disconnects the communication connection between the IM 151-8 PN/DP CPU interface module and a communication partner.

- Use with UDP

FB 66 "TDISCON" disconnects the local communication access point, i.e., the connection between the user program and the communication layer of the operating system is interrupted.

## Options for interrupting the communication connection

Events causing interruptions of communication:

- You program the cancellation of connections at FB 66 "TDISCON."
- The IM 151-8 PN/DP CPU interface module changes from RUN to STOP.
- With POWER OFF / POWER ON

## Reference

For detailed information on the blocks described earlier, refer to the *STEP 7 Online Help*.

## 3.5 S7 connections

### 3.5.1 S7 connection as communication path

An S7 connection is established when S7 modules communicate with one another. This S7 connection is the communication path.

---

#### Note

No S7 connections are required for communication via PROFIBUS DP, PROFINET CBA, PROFINET IO, web server, TCP/IP, ISO on TCP, UDP and SNMP.

---

Each communication link requires S7 connection resources on the IM151-8 PN/DP CPU interface module for the entire duration of this connection.

Thus, each IM151-8 PN/DP CPU interface module is provided with a specific number of S7 connection resources. These are used by various communication services (PG / OP communication or S7 communication).

#### Connection points

An S7 connection between modules with communication capability is established between connection points. The S7 connection always has two connection points: The active and passive connection points:

- The active connection point is assigned to the module that establishes the S7 connection.
- The passive connection point is assigned to the module that accepts the S7 connection.

Any module that is capable of communication can thus act as an S7 connection point. At the connection point, the established communication link always uses one S7 connection of the module concerned.

#### Transition point

If you use the routing functionality, the S7 connection between two modules capable of communication is established across a number of subnets. These subnets are interconnected via a network transition. The module that implements this network transition is known as a router. The router is thus the point through which an S7 connection passes.

Each IM 151-8 PN/DP CPU interface module (with DP master module) can be a route for an S7 connection. You can establish a certain maximum number of routing connections. This does not limit the data volume of the S7 connections.

#### See also

Connection resources for routing (Page 48)

## 3.5.2 Assignment of S7 connections

There are several ways to allocate S7 connections on a communication-capable module:

- Reservation during configuration
- Assigning connections in the program
- Allocating connections during commissioning, testing and diagnostics routines
- Allocating connection resources to HMI services

### Reservation during configuration

One connection resource each is automatically reserved on the IM151-8 PN/DP CPU interface module for programming device and OP communication. Whenever you need more connection resources (for example, when connecting several OPs), configure this increase in the IM151-8 PN/DP CPU interface module properties dialog box in *STEP 7*.

Connections must also be configured (using *NetPro*) for the use of S7 communication. For this purpose, connection resources have to be available, which are not allocated to programming device/OP or other connections. The required S7 connections are then permanently allocated for S7 communication when the configuration is uploaded to the IM151-8 PN/DP CPU interface module.

### Assigning connections in the program

In open Industrial Ethernet communication with TCP/IP, the user program establishes the connection. In doing so, the operating system of the IM151-8 PN/DP CPU interface module initiates the connection. The open IE communication does not use any S7 connections. The maximum number of eight connections also applies to this type of communication.

### Using connections for commissioning, testing and diagnostics

An active online function on the engineering station (programming device /PC with *STEP 7*) assigns S7 connections for programming device communication:

- An S7 connection resource for programming device communication which was reserved in your IM151-8 PN/DP CPU interface module hardware configuration is assigned to the engineering station, that is, it just needs to be allocated.
- If all reserved S7 connection resources for programming device communication are allocated, the operating system automatically assigns a free S7 connection resource which has not yet been reserved. If no more connection resources are available, the engineering station cannot communicate online with the IM151-8 PN/DP CPU interface module.

### Allocating connection resources to HMI services

An online function on the HMI station (OP/TP/... with *WinCC*) is used for assigning S7 connection resources for the OP communication:

- An S7 connection resource for programming device communication which was reserved in your IM151-8 PN/DP CPU interface module hardware configuration is assigned to the HMI station, that is, it just needs to be allocated.
- If all reserved S7 connection resources for OP communication are allocated, the operating system automatically assigns a free S7 connection resource which has not yet been reserved. If no more connection resources are available, the HMI station cannot communicate online with the IM151-8 PN/DP CPU interface module.

### Chronological order in which S7 connection resources are assigned

When you program your project in *STEP 7*, the system generates parameter assignment blocks which are read by the modules in the startup phase. This allows the module's operating system to reserve or assign the relevant S7 connection resources. This means, for example, that OPs cannot access an S7 connection resource that has been reserved for programming device communication. If the IM151-8 PN/DP CPU interface module has S7 connection resources that have not been reserved, these can be used freely. These S7 connection resources are allocated in the order they are requested.

### Example

If there is only one free S7 connection left on the IM151-8 PN/DP CPU interface module, you can still connect a programming device to the bus. The programming device can then communicate with the IM151-8 PN/DP CPU interface module. However, the S7 connection will always be used if the PD is communicating with the IM151-8 PN/DP CPU interface module. If you connect an OP to the bus while the programming device is not communicating, the OP can establish a connection to the IM151-8 PN/DP CPU interface module. Since an OP maintains its communication link at all times, in contrast to the PG, you cannot subsequently establish another connection via the PG.

### See also

Open communication via Industrial Ethernet (Page 41)

### 3.5.3 Distribution and availability of S7 connection resources

#### Distribution of connection resources

Table 3- 3 Distribution of connections

Communication service	Distribution
Programming device communication OP communication S7 basic communication	In order to avoid allocation of connection resources being dependent only on the chronological sequence in which various communication services are requested, connection resources can be reserved for these services. For PG and OP communication, at least one connection resource is reserved by default. The following table and the technical specifications for the IM151-8 PN/DP CPU interface module contain the configurable S7 connections and the default setting. You "redistribute" the connection resources by setting the relevant IM151-8 PN/DP CPU interface module parameters in <i>STEP 7</i> .
S7 communication	Available connection resources that are not specially reserved for a service (programming device / OP communication, S7 basic communication) are used for this.
Routing PG functions	Together with the DP master module, the IM 151-8 PN/DP CPU interface module has a number of connection resources available for routing purposes. These connections are available in addition to the connection resources. The subsection below shows the number of connection resources.
PROFIBUS DP	This communication service requires no S7 connection resources.
PROFINET CBA	This communication service requires no S7 connection resources.
PROFINET IO	This communication service requires no S7 connection resources.
Web server	This communication service requires no S7 connection resources.
Open communication via TCP/IP	This communication service requires no S7 connection resources.
Open communication by means of ISO on TCP	Independently of the S7 connections, a total of 8 own resources are available for connections or local access points (UDP) for TCP/IP, ISO on TCP, UDP.
Open communication by means of UDP	
SNMP	This communication service requires no S7 connection resources.

### Availability of connection resources

Table 3- 4 Availability of connection resources

Interface module	Total number connection resources	Reserved for			Free S7 connections
		Programming device communication	OP communication	S7 basic communication	
IM 151-8 PN/DP CPU	12	1 to 11 default 1	1 to 11 default 1	0 to 10 default 0	Displays all non-reserved S7 connections as free connections.

**Note**

If you are using the IM151-8 PN/DP CPU interface module, you can configure up to 10 connection resources for S7 communication in *NetPro*. These connections are then reserved.

### 3.5.4 Connection resources for routing

#### Number of connection resources for routing

In addition to the S7 connection resources, a maximum of 4 connections are available on the PROFINET interface of the IM151-8 PN/DP CPU interface module for the routing function. Routing is only possible if the DP master module is connected and configured.

#### Example for the IM 151-8 PN/DP CPU

The IM 151-8 PN/DP CPU interface module makes available 12 connection resources:

- Reserve two connection resources for programming device communication.
- Reserve two connection resources for OP communication.
- In *NetPro* you configure 3 S7 connection resources for S7 communication via the integrated PROFINET interface.

This leaves 5 S7 connections available for any communication services, e.g. S7 communication, OP communication, etc.

However, no more than 10 connection resources for S7 communication at the integrated PN interface can be configured in *NetPro*.

There are also 4 routing connections available for the IM151-8 PN/DP CPU interface module that do not affect the S7 connection resources mentioned above.



## 3.6 DPV1

New automation and process engineering tasks require the range of functions performed by the existing DP protocol to be extended. In addition to cyclical communication functions, acyclical access to non-S7 field devices is another important requirement of our customers, and was implemented in the EN 50170 standard. In the past, acyclic access was only possible with S7 slaves. The standard concerning distributed I/Os (EN 50170) has been further developed. All the changes concerning new DPV1 functions are included in IEC 61158/ EN 50170, volume 2, PROFIBUS.

### Definition DPV1

The term DPV1 is defined as a functional extension of the acyclic services (to include new interrupts, for example) provided by the DP protocol.

### Availability

Together with the DP master module you can operate the IM 151-8 PN/DP CPU interface module as a DP master via the expanded DPV1 functionality.

### Requirement for using the DPV1 functionality with DP slaves

For DPV1 slaves from other vendors, you will need a GSD file conforming to EN 50170, revision 3 or later.

### Extended functions of DPV1

- Use of any DPV1 slaves from external vendors (in addition to the existing DPV0 and S7 slaves, of course).
- Selective handling of DPV1-specific interrupt events by new interrupt blocks.
- Reading/writing SFBs that conform to standards to the data record (although this can only be used for centralized I/O modules).
- User-friendly SFB for reading diagnostics.

### Interrupt blocks with DPV1 functionality

Table 3- 5 Interrupt blocks with DPV1 functionality

OB	Functionality
OB 40	Process interrupt
OB 55	Status interrupt
OB 56	Update interrupt
OB 57	Vendor-specific interrupt
OB 82	Diagnostic interrupt

**Note**

You can now also use organization blocks OB40 and OB82 for DPV1 interrupts.

### System blocks with DPV1 functionality

Table 3- 6 System function blocks with DPV1 functionality

SFB	Functionality
SFB 52	Read data record from DP slave / IO device or centralized I/O module
SFB 53	Write data record to DP slave / IO device or centralized I/O module
SFB 54	Read additional alarm information from a DP slave / IO device or a centralized I/O module in the relevant OB
SFB 75	Set any interrupts for intelligent slaves

**Note**

You can also use SFB 52 to SFB 54 for centralized I/O modules. SFBs 52 to 54 can also be used for PROFINET IO.

### Reference

For additional information on the above blocks can be found in the *System and Standard Functions for S7-300/400* reference manual, or in the *STEP 7 Online Help*.

### See also

PROFIBUS DP (Page 32)

## 3.7 Web server

### Introduction

The web server allows you to monitor your IM 151-8 PN/DP CPU interface module over the Internet or your company's intranet. This allows analyses and diagnostics to be carried out remotely.

Messages and status information are displayed on HTML pages.

### Web browser

You will need a web browser to access the HTML pages for the IM 151-8 PN/DP CPU interface module .

The following web browsers are suitable for communication with the IM 151-8 PN/DP CPU interface module:

- Internet Explorer (version 6.0 or later)
- Mozilla Firefox (version 1.5 or later)
- Opera (version 9.0 or later)
- Netscape Navigator (version 8.1 or later)

### Reading information via the web server

Via the web server, you can read the following information from the IM 151-8 PN/DP CPU interface module:

- firmware V2.7 or later
  - Start page with general information
  - Identification data
  - Contents of the diagnostics buffer
  - Messages (without acknowledgment option)
  - - PROFINET (communication)
  - Variable status
  - Variable tables
- from firmware V3.2 and configuration with STEP 7 V5.5
  - Module state
  - Communication: Display the OUC connections and the resources
  - Topology: Display the setpoint and current topology from the configuration
  - User pages (WEB2PLC required)

The following pages describe the HTML pages and contain detailed explanatory notes.

### Web access to the IM 151-8 PN/DP CPU interface module via PD / PC

Proceed as follows to access the web server:

1. Connect the client (programming device or PC) to the IM 151-8 PN/DP CPU interface module via the PROFINET interface.
2. Open the web browser (e.g. Internet Explorer).

Enter the IP address of the IM 151-8 PN/DP CPU interface module in the "Address" field of the web browser in the format `http://a.b.c.d` or `https://a.b.c.d` (for example: `http://192.168.3.141`).

The start page of the IM 151-8 PN/DP CPU interface module opens. From the start page you can navigate to additional information.

---

#### Note

Up to 5 http / https connections are possible.

---

### Web access to the IM 151-8 PN/DP CPU interface module via HMI devices and PDA

The web server also supports the Windows terminal service which means that thin client solutions with mobile devices (e.g. PDA or MOBIC T8) and robust local stations (e.g. SIMATIC MP370 with the ThinClient/MP option) can be implemented under Windows CE, in addition to the use of programming devices and PCs.

Proceed as follows to access the web server:

1. Connect the client (HMI device, PDA) to the IM 151-8 PN/DP CPU interface module via the PROFINET interface.
2. Open the web browser (for example, Internet Explorer).

Enter the IP address of the IM 151-8 PN/DP CPU interface module in the "Address" field of the web browser in the format `http://a.b.c.d/basic` or `https://a.b.c.d/basic` (for example: `http://192.168.3.141/basic`).

The start page of the IM 151-8 PN/DP CPU interface module opens. From the start page you can navigate to additional information.

The IM 151-8 PN/DP CPU interface module information is processed in a specially-designed browser for HMI devices running under Windows CE earlier than V 5.x. The information appears in a simplified format in this browser. The following illustrations show the detailed form respectively.

## Web servers without SIMATIC Micro Memory Card

---

### Note

#### Using SIMATIC Micro Memory Card together with Web server

The configuration data for the Web server is stored on the SIMATIC Micro Memory Card. We therefore recommend that you use a SIMATIC Micro Memory Card with at least 512 kB.

You can also use the web server without the SIMATIC Micro Memory Card inserted. The condition for operation is that you have assigned an IP address to the IM 151-8 PN/DP CPU interface module.

- The content of the diagnostics buffer is displayed in hex code.
  - Start page, identification and communication information as well as variable status are displayed in plain text.
  - Following displays remain empty:
    - Module state
    - Messages
    - Topology
    - Variable tables
    - User pages
  - Automatic page updating is activated by default with no need for configuration.
- 

## Security

The web server offers the following security functions:

- Access via the secure transmission protocol https
- configurable user rights via the user list

In addition, protect your web-compliant IM 151-8 PN/DP CPU interface module against unauthorized access by means of a firewall.

## See also

Language settings (Page 54)

### 3.7.1 Language settings

#### Display languages

The web server provides messages and diagnostics information in the following languages:

- German (Germany)
- English (United States)
- French (France)
- Italian (Italy)
- Spanish (traditional sorting)
- Simplified Chinese
- Japanese

Both Asian languages can be combined as follows:

- Chinese with English
- Japanese with English

#### Conditions for the availability of Asian languages

The following conditions must be fulfilled for the Asian languages Chinese and Japanese:

- The respective language package has been installed on the viewing device (e.g. PC).
- STEP 7 for Asian languages (V5.5) is installed on the PD for the configuration of the IM 151-8 PN/DP CPU interface module.

---

#### Note

SIMATIC HMI devices running the Windows CE operating system do not support any Asian languages.

---

#### What you need to display texts in different languages

You must make two language settings in *STEP 7* so that the web server displays the various languages correctly.

- Setting the language for display devices in SIMATIC Manager
- Set the language for the web in the IM 151-8 PN/DP CPU interface module Properties dialog. For further information, refer to section *Settings in HW Config, "Web" tab*.

## Setting the language for display devices in SIMATIC Manager

Select the languages for display devices in SIMATIC Manager:  
**Options > Language for display devices**

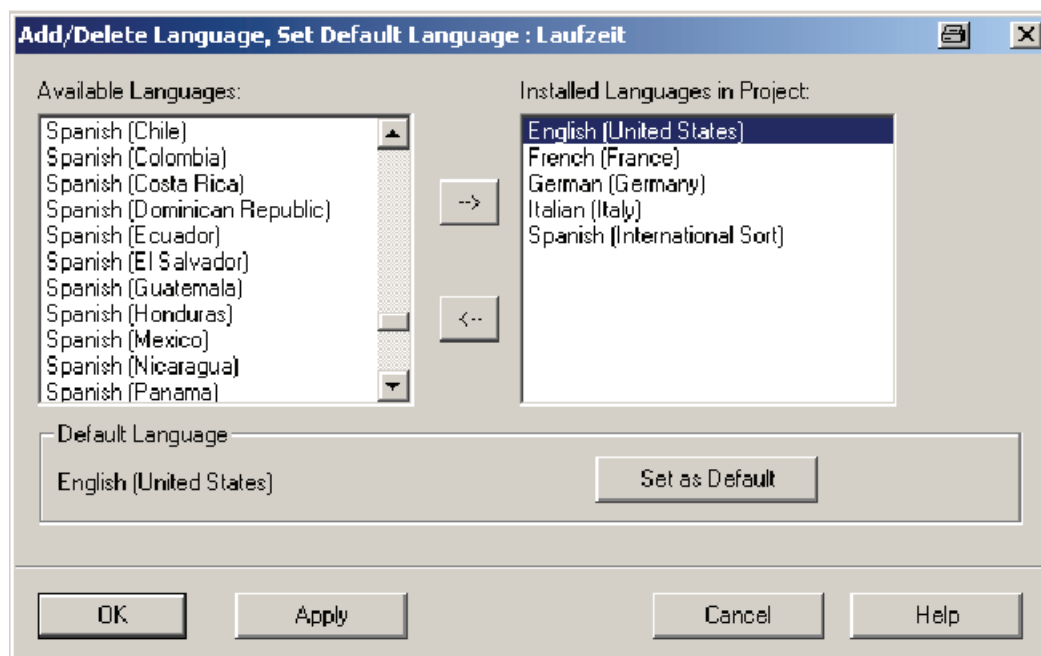

Figure 3-2 Example for selecting the display device language

### 3.7.2 Settings in HW Config, "Web" tab

#### Requirements

You have opened in HW Config the Properties dialog for the IM 151-8 PN/DP CPU interface module.

To use the full functionality of the web server, carry out the following settings in the "Web" tab:

- Activating the web server
- Set the language for Web
- Adding to the user list
- Access activation for HTTPS
- Activate automatic update
- Display classes of the messages

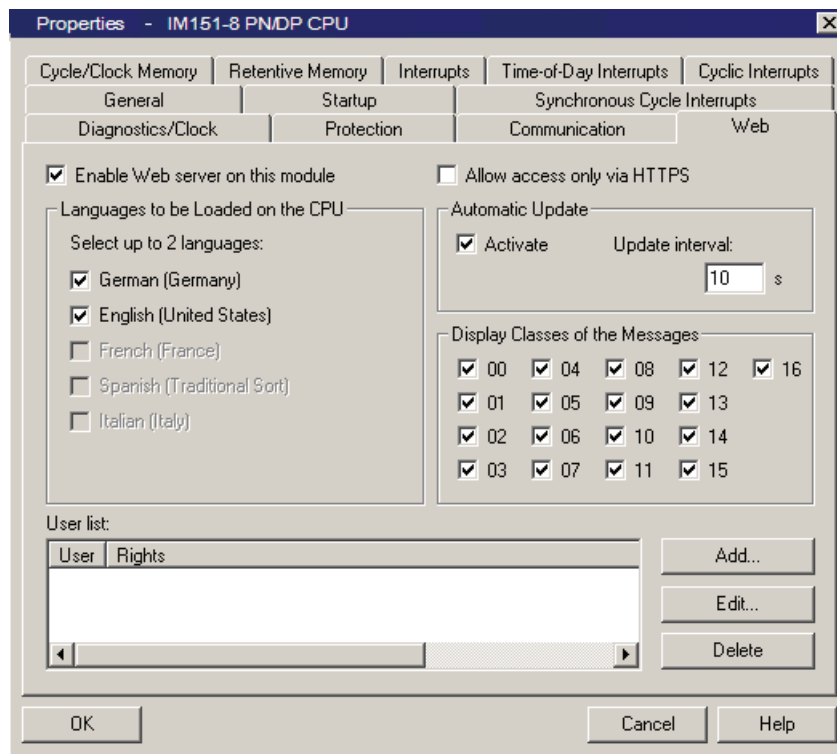

#### ① Activate the web server

The web server is deactivated in HW Config by default. You activate the web server in HW Config.

In the CPU properties dialog:

- Check the "Activate web server on this module" check box.



## ② Set the language for web

Select up to two languages for the Web from the languages installed for display devices.  
In the CPU properties dialog:

- Check the "Activate Web server on this module" check box
- Select up to two languages for the Web.

---

### Note

If you activate the web server and do not select a language, messages and diagnostic information will be displayed in hexadecimal code.

---

## ③ User list

The user list offers you the options to:

- create users,
- specify execution rights,
- assign passwords.

This assignment ensures that the users have access to precisely those options that are specified for those execution rights.

- If no users are specified in the hardware configuration, read-only access is granted to all web pages.
- If users are configured, until a user has logged in he/she has access only to the intro and the start page.
- Once a user is configured and logged in, he/she can access the web pages in accordance with his access rights.
- If a special user is configured with the login "everybody", a user who has not logged in has access **without prior input of the password** to those pages that are enabled for access by "everybody".

If, for instance, "everybody" has the access right to "Read variables", the "Variables table" web page is displayed by default in the main menu bar without prior input of the password.

A maximum of 20 users and "everybody" users can be set up.

## ④ Access only by HTTPS

https ensures encryption of the communication between the browser and web server.

For error-free https access to the IM, the following is required:

- The current time must be set in the IM.
- IP address of the IM (for example, input https://192.168.3.141)
- You require an installed and valid certificate

If no certificate is installed, a warning is displayed with the recommendation not to use the page. To view the page, the user must then explicitly "Add an exception".

A valid certificate (Certification Authority) can be obtained as a download from the "Intro" web page under "Download certificate". For instructions on how to install the certificate, see the "Help" for your respective web browser.

An encrypted connection is shown by a padlock icon in the status bar of the web page.

### ⑤ Activate automatic update

The following web pages can be updated automatically:

- Start page
- Diagnostics buffer
- Module state
- Messages
- Information about communication
- Topology
- Variable status
- Variable table

To enable automatic updates, proceed as follows:

- Set the "Activate" check box at "Automatic update" in the properties dialog of the IM (under the "Web" tab)
- Enter the update interval.

---

#### Note

##### Update time

The activation interval set in the HW Config represents the shortest update time. Larger amounts of data or several http / https connections increase the update time.

---

### ⑥ Display classes of the messages

All message display classes are activated in the basic configuration in HW Config. The messages for the selected display classes are displayed later on the "Messages" web page. Messages for display classes that are not selected are shown as hexadecimal code and not as plain text.

How to configure the message classes:

- For "Report system error" in HW Config under **Options > Report system error**
- For block-specific messages in STEP 7

Information about configuring message texts and classes can be found in *STEP 7*.

---

#### Note

##### Reducing the memory requirement of web SDBs

You can reduce the memory requirement of web SDBs by selecting just the message display classes that are to be filled in the web SDB.

---

### 3.7.3 Updating and saving information

#### Screen content refresh status and printing

##### Screen content

Automatic updating is deactivated in HW Config by default. This means that the screen of the Web server outputs static information.

Refresh the Web pages manually using the <F5> function key or the following icon:



#### Update status of printouts

Data output to the printer always returns the current interface module information. It is therefore possible that the information output to the printer may be more current than the screen contents.

To obtain a print preview of the web page, click the icon:



Filter settings have no effect on the print-out, The printout of the "Messages" and "Module status" web pages always shows the complete content of the pages.

#### Disabling automatic update for an individual web page

To deactivate automatic refresh for a Web page for a short time, select the following icon:



Enable automatic refresh again using the <F5> function key or the following icon:



#### Saving messages and entries of the diagnostics buffer

Messages and diagnostics buffer entries can be saved to a csv file. Use the following symbol to save the data.



A dialog box opens in which you can enter the file name and target directory.

To prevent incorrect display of the data in Excel, do not open the csv file with double-click. Import the file in Excel by selecting the "Data" and "Import external data" menu command.

### 3.7.4 Web pages

#### 3.7.4.1 Start page with general CPU information

##### Establishing a connection to the web server

Connect to the web server by entering the IP address of the configured IM151-8 PN/DP CPU interface module on the web browser's address bar (e.g. <http://192.168.1.158> or <https://192.168.1.158>). The connection is established and the "Intro" page opens.

---

##### Note

Here we show and explain **by way of examples**, how the various web pages may appear.

---

##### Intro

The web server calls the following page upon start-up:



Figure 3-3 Intro

Click on the ENTER link to access the web server pages.

### Note

#### Skip website intro

Check the "Skip Intro" check box to skip the intro. You will then access the web server's start page directly in future. You can reverse the "Skip intro" setting by clicking on the "Intro" link on the start page.

## Start page

The start page contains information as shown below. The image of the IM151-8 PN/DP CPU interface module with LEDs reflects your current status at the time of checking the data.

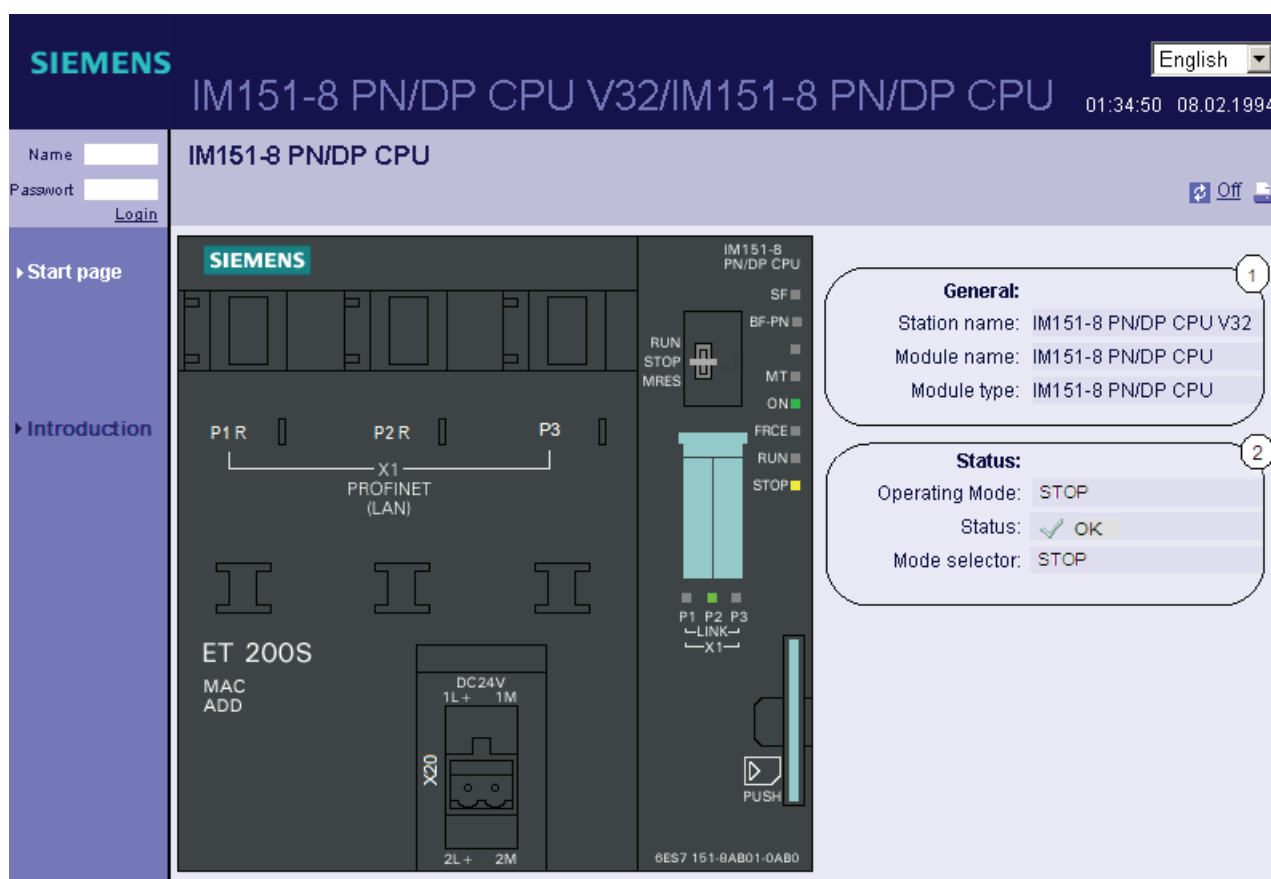

Figure 3-4 Start page before login

## Login

In order to use the full functionality of the web pages, you must be logged in: Log in using one of the user names and passwords specified in the WEB configuration for the hardware. You then have the user's access rights to the web pages assigned to them. For further information, refer to section Settings in HW Config, "Web" tab (Page 56).

① "General"

Information about the IM151-8 PN/DP CPU interface module, the web server with which you are currently connected, is combined in this group.

② "Status"

Status information about the IM151-8 PN/DP CPU interface module at the time of the query is displayed in the "Status" info field.

Reference

Further information about http / https connections can be found in section Settings in HW Config, "Web" tab (Page 56).

3.7.4.2 Identification

Characteristics

The "Identification" web page contains the characteristic data for the IM151-8 PN/DP CPU interface module.

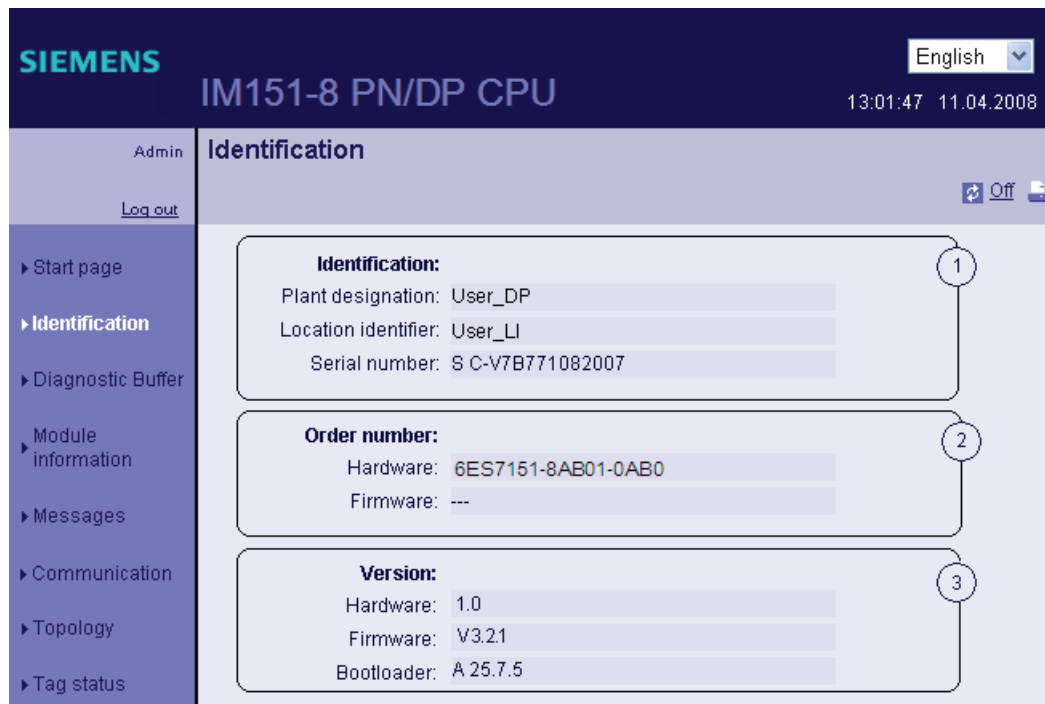

Figure 3-5 Identification

① **"Identification"**

The "Identification" info field contains the system and location designations as well as the serial number.

Plant and location designations can be configured in HW Config in the properties dialog box of the IM, "General" tab.

② **"Order number"**

The "Order number" info field contains order numbers for the hardware and software.

③ **"Version"**

The hardware, firmware and boot loader versions are displayed in the "Version" info field.

### 3.7.4.3 Diagnostic buffer

#### Diagnostics buffer

The browser displays the content of the diagnostics buffer on the "Diagnostics buffer" web page.

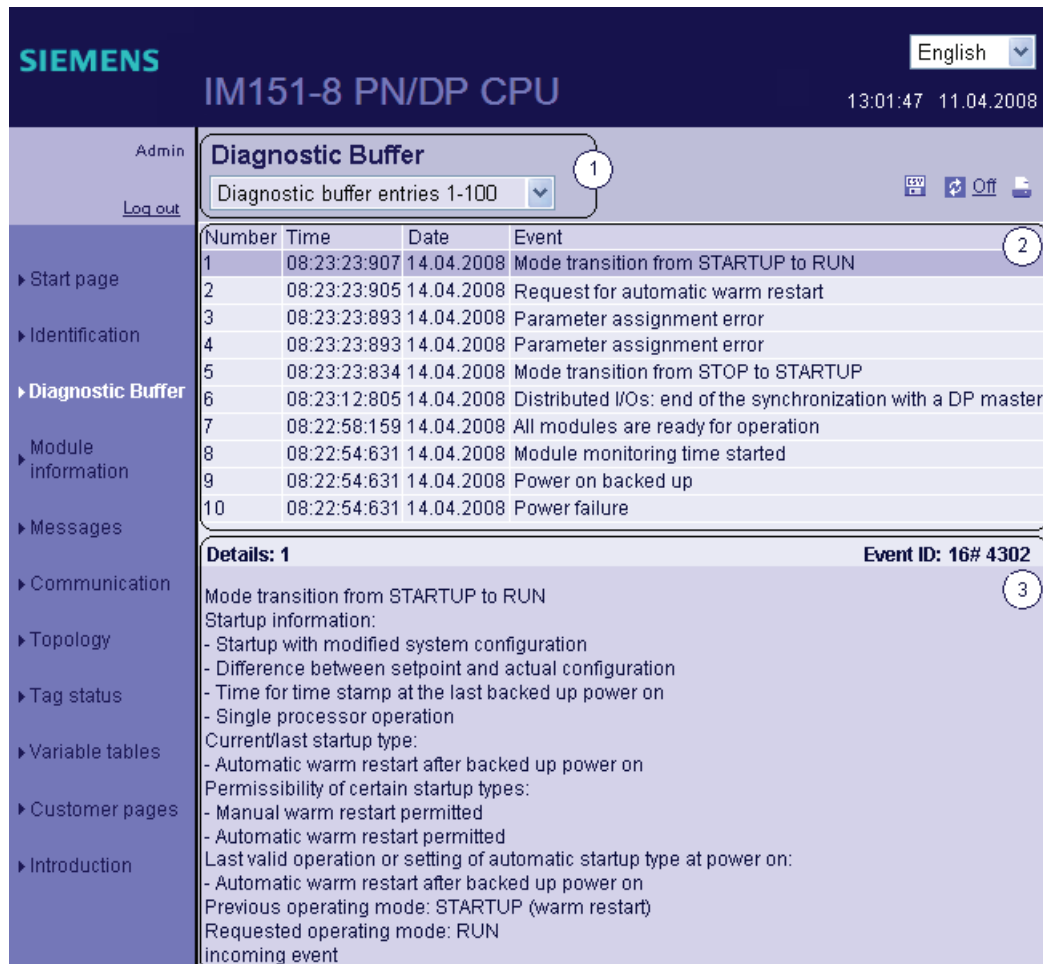

Figure 3-6 Diagnostics buffer

#### Requirement

You must have activated the web server, made the language setting and compiled and loaded the project in *STEP 7*.



### ① "Diagnostics buffer entries 1-100"

The diagnostics buffer may contain up to 500 messages. Select an interval for the buffer entries from the list box. Each interval contains 100 entries.

For interface modules  $\geq$  V3.2, the number of the displayed diagnostic buffer entries in the RUN can be assigned parameters between 10 and 499 in the properties dialog of the CPU ("Diagnostics / Clock" tab). In RUN, 10 entries are set as default.

### ② "Events"

The "Events" info field contains the diagnostic events with the date and time.

### ③ "Details"

This box contains detailed information about the selected event.

Select the event from the ② "Events" info field.

## Configuration

Configuration involves the following steps:

1. Select the "Object properties" dialog box from the context menu of the relevant IM151-8 PN/DP CPU interface module.
2. Select the "Web" tab and check the "Activate web server on this module" check box.
3. Select up to two languages to be used to display plaintext messages.
4. Save and compile the project and download it to the IM151-8 PN/DP CPU interface module.

## Point to note when changing between languages

You can change the language, e.g. from German to English, in the top right-hand corner. If you select a language that you have not configured, then the information will appear as hexadecimal code, rather than in plaintext.

### 3.7.4.4 Module state

#### Requirements

- You have carried out the following settings in HW Config:
  - Web server activated
  - Language settings carried out
  - "Report system error" generated and activated
- You have compiled the project using STEP 7 HW Config, loaded the SDB container and the user program (in particular the user program blocks generated by "Report system error")
- The IM is in RUN mode.

---

#### Note

##### "Report system error"

- **Duration of the display:** Depending on the plant extension level, the "Report system error" display requires some time to create the initial evaluation of the state of all the configured I/O modules and I/O systems. During this time there is no concrete display of the status on the "Module status" web page. A "?" is displayed in the "Status" column.
  - **Dynamic response:** "Report system error" has to be called up cyclically at least every 100 ms.  
Calling up can take place in OB 1, or if the cycle time amounts to more than 100 ms, in the watchdog interrupt OB 3x ( $\leq 100$  ms) and in the restart OB 100.
  - **Diagnostics support:** In the "Report system error" dialog box, the "Diagnostic status DB" tab must be selected in the "Diagnostics support" tab and a DB number entered. This check box is normally selected as default with configured Web servers. During the migration of old project, it may however be necessary to select this check box.
-

## Status of the modules

The state of a station is indicated by means of symbols and comments on the "Module status" web page.

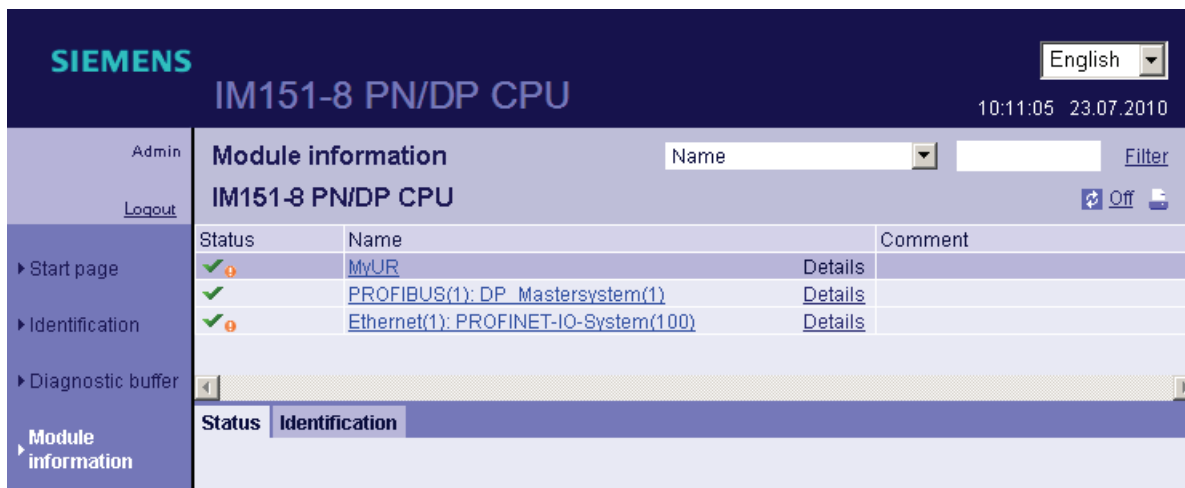

Figure 3-7 Module status - station

## Meaning of the symbols in the "Status" column

Symbol	Color	Meaning
	green	Component OK
	gray	Disabled PROFIBUS slaves or PROFINET devices Support conditions: <ul style="list-style-type: none"> <li>IM151-8 PN/DP CPU <math>\geq</math> V3.2 and STEP 7 V5.5</li> <li>Enabling/disabling the PROFIBUS slaves and PROFINET IO devices using SFC12 mode 3/4</li> <li>In the "Report System Error" dialog, in the "Diagnostics support" tab, area "Status activated/deactivated", a check must be set in the "Device interrogation for status 'activated/deactivated' after CPU start-up" check box, optionally also in the "Generate alarm at change of status" check box.</li> </ul>
	black	Component cannot be accessed/Status cannot be determined <ul style="list-style-type: none"> <li>The "Status cannot be determined" is, for example, always displayed in the STOP mode of the CPU or during the initial evaluation of "Report system error" for all the configured I/O modules and I/O systems after the CPU has been restarted.</li> <li>However, this status can also be displayed temporarily during operation if a diagnostic interrupt burst occurs at all modules.</li> <li>For modules of a subsystem, which is connected to a CP, no status can be determined.</li> </ul>
	green	Maintenance required
	yellow	Maintenance requested
	red	Error - component failed or faulty
	-	Error in a lower module level

### Navigation to further module levels

The status of individual components/modules/submodules is displayed when you navigate to the further module levels:

- To higher module levels using the links in the display of the module levels ②
- To lower module levels using the links in the "Name" column

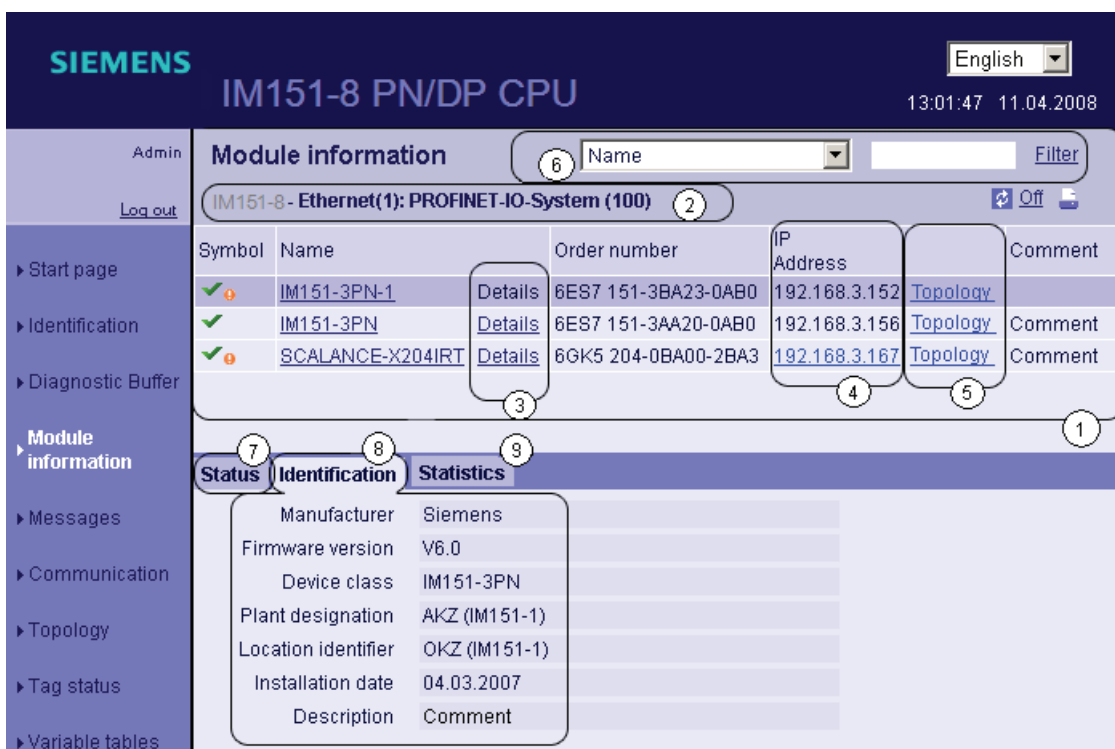

Figure 3-8 Module status - module

#### ① "Module status"

Depending on the selected level, the table contains information about the rack, the DP master system, the PNIO master system, about the nodes, the individual modules, or also the modules or submodules of the station.

#### ② "Display of the module levels"

The links are used to access the "Module status" of the higher module levels.

#### ③ "Details"

Further information about the selected module is provided in the "Status" and "Identification" tabs via the "Details" link.

④ "IP address"

If a link is available here, clicking on it will take you to the web server of the selected configured device.

⑤ "Topology"

The two web pages, "Topology" and "Module status", are linked. When you click on the "Topology" of the selected module, you automatically jump to this module in the graphic view of the setpoint topology on the "Topology" web page. The module appears in the visible area of the "Topology" web page and the device head of the selected module flashes for a few seconds.

⑥ "Filter"

You can search in the table by selecting specific criteria:

1. Select a parameter from the drop-down list box.
2. If applicable, enter the value of the selected parameter.
3. Click on "Filter".

The filter criteria are also retained when you update a page.

To deactivate the filter settings, click "Filter" again.

⑦ "Status" tab

The tab contains information about the status of the selected module when a fault or message exists.

⑧ "Identification" tab

The tab contains data on the identification of the selected module.

---

**Note**

This tab displays only data configured offline, no online data of modules.

---

⑨ "Statistics" tab

The tab is shown only for PROFINET IO devices. It contains the following information about the communications statistics of the selected IO device:

- Overall Statistics - "Transmitted Data Packets"  
The quality of the data transmission on the transmission line can be determined from the key figures in this info box.
- Overall Statistics - "Received Data Packets"  
The quality of the data transmission on the reception line can be determined from the key figures in this info box.
- Statistics port x - "Sent data packets"  
The quality of the data transmission on the transmission line can be determined from the key figures in this info box.
- Statistics port x - "Received data packets"  
The quality of the data transmission on the reception line can be determined from the key figures in this info box.

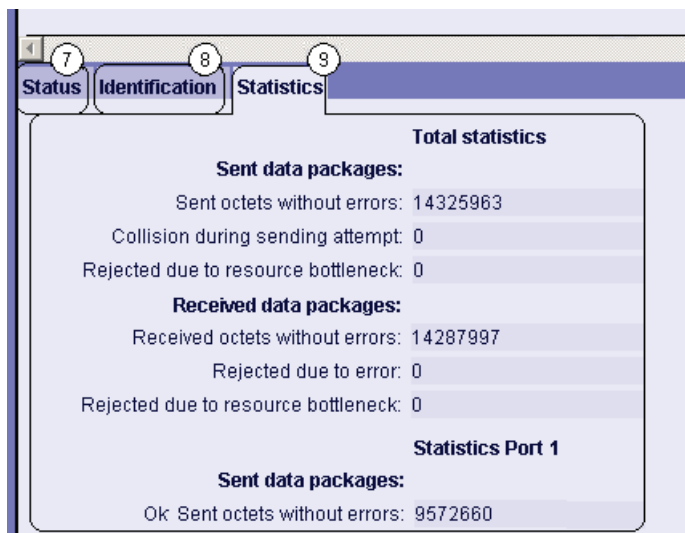

See also the tab "Statistics in the section "Communication (Page 73)".

Example: Module status - module

**SIEMENS** IM151-8 PN/DP CPU V32/IM151-8 PN/DP CPU 10:11:05 23.07.2010

Admin | **Module information** | Slot: [dropdown] | Filter

Logout | [IM151-8 PN/DP CPU V32 - Ethernet\(8\): PROFINET-IO-System \(100\)](#) - [IM151-3PNHFV60-1](#) | Off

Slot	Status	Name	Order number	I address	Q address	Comment
0	✓	IM151-3PNHFV60-1	6ES7 151-3BA23-0AB0		0.0	
1	✓	PM-E DC24V	6ES7 138-4CA01-0AA0	8171		
2	✓	4DI CD24V HF	6ES7 131-4BC01-0AB0	1.0		
3	🔧	4DO DC24V/0,5A ST	6ES7 132-4BD01-0AA0		1.0	

Module information: PN device 3 on PN system 100 Slot: 3: Module removed  
Name: IM151-3PNHFV60-1 Module: 2DO DC24V/0.5A HF  
I/O address: A1

Figure 3-9 Module status - module

Example: Module status - submodule

**SIEMENS** IM151-8 PN/DP CPU 13:01:47 11.04.2008

Admin | **Module information** | Slot: [dropdown] | Filter

Logout | [IM151-8 PN/DP -Ethernet\(1\): PROFINET-...](#) - [IM151-3PNHFV60-1](#) - [IM151-3PNHFV60-1](#) | Off

Slot	Symbol Name	Order number	I Addr.	O Addr.	Comment
X1	MyIM151-3PN (3)	6ES7 151-3BA23-0AB0	8172		...bus system PNIO
X1 P1	MyPort 1 (3)	6ES7 151-3BA23-0AB0	8175		...PNIO-Port 1 (3)
X1 P2	MyPort 2 (3)	6ES7 151-3BA23-0AB0	8174		...PNIO-Port 2 (3)

Status | Identification

Figure 3-10 Module status - submodule

**Reference**

For further information about the "Module status" and about the topic "Configuring 'Signaling system errors'", refer to the *STEP 7 Online Help*.

**3.7.4.5 Messages**

**Requirement**

The message texts must have been configured in the correct languages. For information about configuring message texts, refer to *STEP 7* and to the Service&Support pages (<http://support.automation.siemens.com/WW/view/en/23872245>).

**Messages**

The browser displays the content of the message buffer on the "Messages" web page. You cannot acknowledge the messages via the web server.

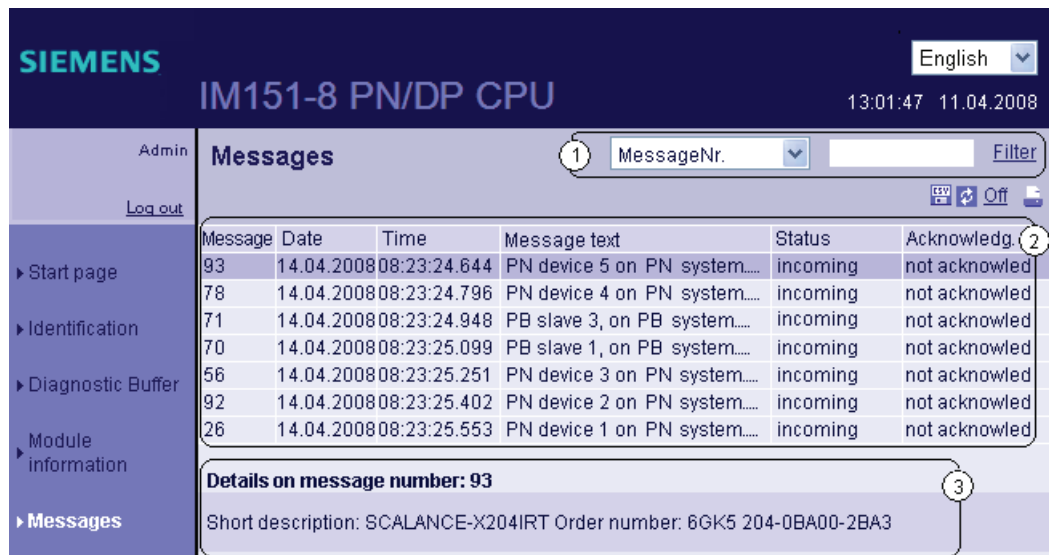

Figure 3-11 Messages

**① "Filter"**

It offers the ability to filter using certain criteria.

1. Select a parameter from the drop-down list box.
2. If applicable, enter the value of the selected parameter.
3. Click on "Filter".

The filter criteria are retained even when a page is automatically updated.

To deactivate the filter settings, click "Filter" again.

**Effects**

- The filter settings are also retained when you update a page.
- Filter settings have no effect on the print-out. The print-out always shows the entire contents of the message buffer.



## ② "Messages"

Interface module messages are displayed in chronological order in the info field ②, together with the **date** and **time**.

The **Message text** parameter relates to the entering of message texts configured for the particular error definitions.

### Sort

You also have the option of displaying the individual parameters in ascending or descending order. To do this, click on one of the parameters in the column header:

- Message number
- Date
- Time-of-day
- Message text
- State
- Acknowledgement

If you click "Date", the messages will be displayed in chronological order.

Incoming and outgoing events are output in the **Status** parameter.

## ③ "Details for message number"

This info field is used to display detailed information about a message. Select the message for which you are interested in the details from the info field ②.

### Point to note when changing between languages

You can change the language, e.g. from German to English, in the top right-hand corner. If you select a language that you have not configured or for which no message text was configured, then the information will appear as hexadecimal code, rather than in plaintext.

## 3.7.4.6 Communication

### Overview

On the "Communication" web page you can find detailed information about the following tabs:

- Parameters
- Statistics
- Resources
- Open user communication

### "Parameters" tab

The "Parameters" tab ① of this web page contains a summary of information about the integrated PROFINET interface of the interface module.

The designations of the modules are for illustrative purposes only.

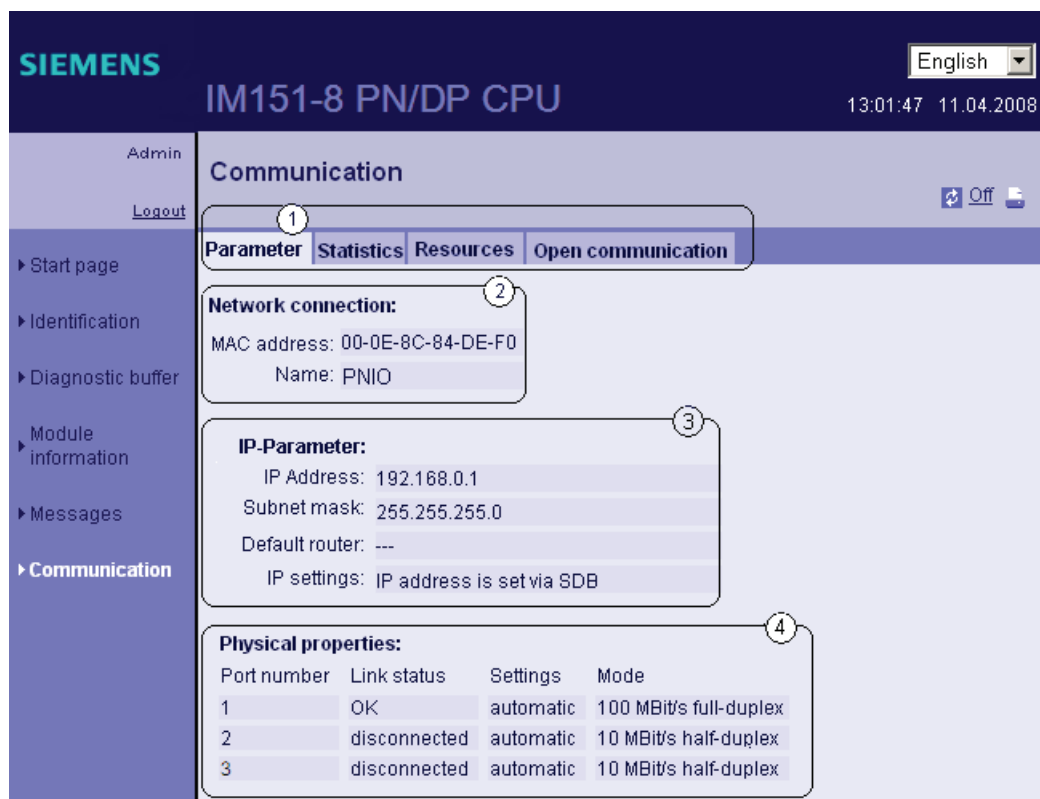

Figure 3-12 Parameters of the integrated PROFINET interface

#### ② "Network connection"

Here you will find information that will help you to identify the integrated PROFINET interface of the IM151-8 PN/DP CPU interface module.

#### ③ "IP parameters"

Information about the configured IP address and number of the subnet containing the IM151-8 PN/DP CPU interface module.

#### ④ "Physical properties"

The following information is available in the "Physical properties" info field:

- Port number
- Link status
- Settings
- Mode

"Statistics" tab

Information about the quality of the data transmission can be found in the tab ① "Statistics".

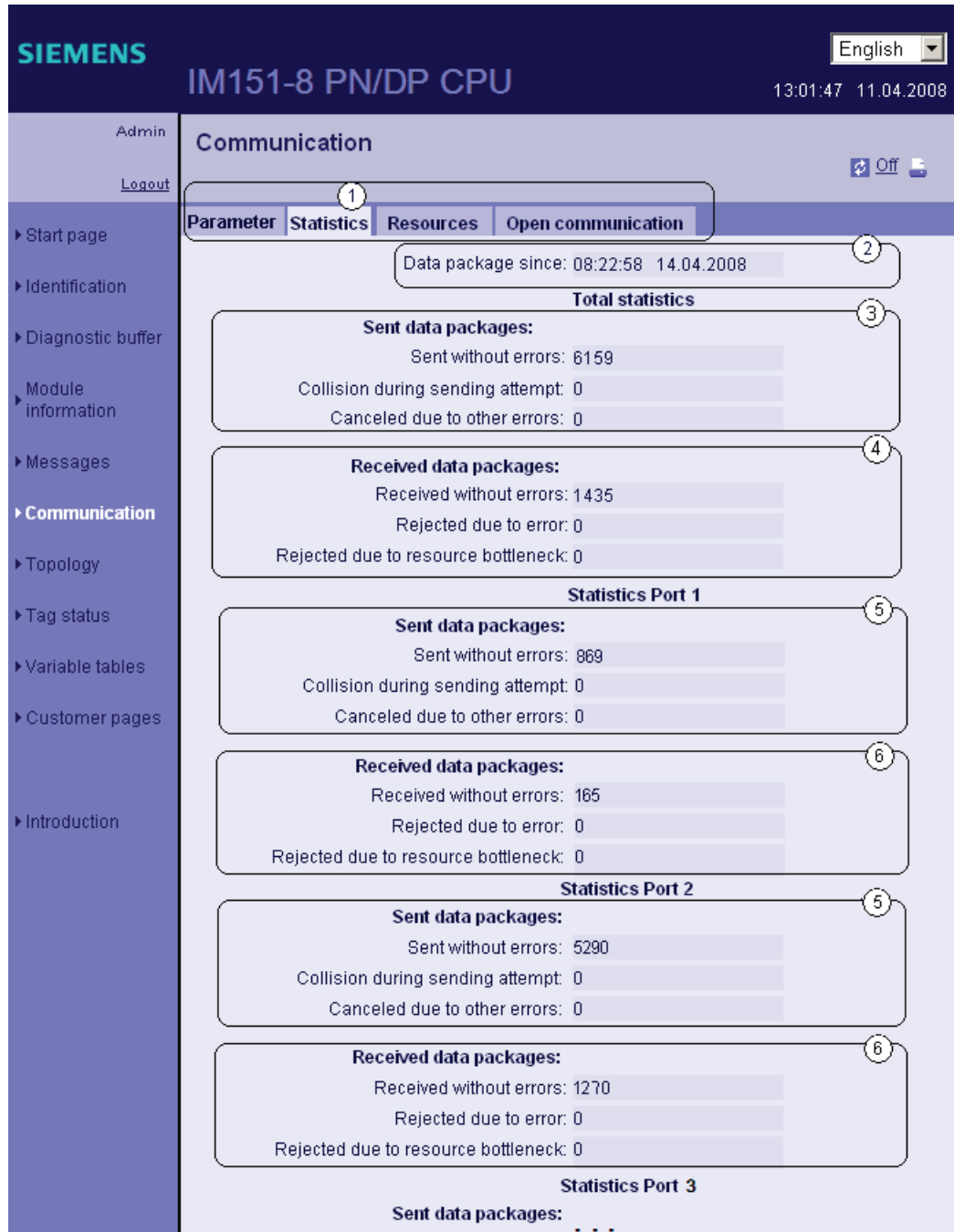

Figure 3-13 Key data transmission figures

② "Data packets since"

This shows the time at which the first data packet was sent or received after the last Power on/memory reset.

### ③ "Total statistics - Sent Data Packets"

The quality of the data transmission on the transmission line can be determined from the key figures in this info box.

### ④ "Overall Statistics - Received Data Packets"

The quality of the data transmission on the reception line can be determined from the key figures in this info box.

### ⑤ "Statistics Port 1 / Port 2 / Port 3- Sent Data Packets"

The quality of the data transmission on the transmission line can be determined from the key figures in this info box.

### ⑤ "Statistics Port 1 / Port 2 / Port 3 - Received Data Packets"

The quality of the data transmission on the reception line can be determined from the key figures in this info box.

## Tab "Resources"

Information on resource consumption by the connections can be found under the "Resources" tab ①.

The screenshot shows the Siemens IM151-8 PN/DP CPU web interface. The top bar includes the Siemens logo, the device name 'IM151-8 PN/DP CPU', a language dropdown set to 'English', and the time '13:01:47' and date '11.04.2008'. The left navigation menu has 'Communication' selected. The main content area has tabs for 'Parameter', 'Statistics', 'Resources', and 'Open communication'. The 'Resources' tab is active and contains two information boxes:

- Number of connections:**
  - Maximum connections: 12
  - Connections not assigned: 11
- Connections:**

	reserved	assigned
PG communication	1	1
OP communication	1	0
S7 Basic communication	0	0
S7 communication	0	0
Other communication	0	0

### ② Number of connections

Here you can find information about the maximum number of connections and the number of non- assigned connections.

### ③ Connections

Here you can find information about the number of reserved connections and assigned connections for PD, OP, S7 basic communication, S7 communication and other communications.

#### "Open communications" tab

Information on the status of the communication connections can be found in the "Open communications" tab ①.

The screenshot shows the Siemens IM151-8 PN/DP CPU interface. The top header displays 'SIEMENS IM151-8 PN/DP CPU' and 'English'. The left navigation menu includes 'Admin', 'Log out', 'Start page', 'Identification', 'Diagnostic buffer', 'Module information', 'Messages', 'Communication', 'Topology', 'Tag status', 'Variable tables', and 'Customer pages'. The main content area is titled 'Communication' and has a language dropdown set to 'English'. Below the title is a navigation bar with tabs: 'Parameter', 'Statistics', 'Resources', and 'Open communication' (marked with ①). The 'Open communication' tab displays a table with the following data:

Status	ID	Remote IP	Type
✔ Connection has been set up	#16 0001	---	UDP
✘ Connection is being established a	#16 0002	192.168.3.148	TCP
✔ Connection has been established	#16 0003	192.168.3.148	ISO on TCP

The table is marked with ②. Below the table is a 'Details: #16 0003' section (marked with ③) showing the following information:

- Local IP address: 192.168.3.147
- Local TSAP (hexadecimal): E0 02 AA
- Local TSAP (ASCII): ---
- Remote IP address: 192.168.3.148
- Remote TSAP (hexadecimal): E0 02 AA
- Remote TSAP (ASCII): ---
- Current connection establishment attempts: 0
- Successful connection establishment attempts: 1
- Bytes sent: 94139340
- Bytes received: 60496560
- Error message of last disconnection: ---

## ② Status information

Here you can find an overview of the connections being established and the connections already established or set up for open communication via industrial Ethernet.



The table contains the following information for each connection:

- "Status" column: Connection status incl. symbol
- "ID" column: Connection ID
- "Remote IP" column: Remote IP address
- "Type" column: Connection type

The connection statuses available depend on the connection type. This dependency is shown in the following table:

Connection type	Available connection statuses	Meaning
TCP, ISO on TCP	Connection is established actively / passively	The user has triggered the connection request for an active / passive connection using the TCON block.
	The connection is established actively / passively	The connection triggered using the TCON block has been established.
UDP	Connection is established	-

The following symbols are used for the connection status:

Icon	Color	Meaning
	green	<ul style="list-style-type: none"> <li>• connection is established (using UDP)</li> <li>• Connection is established actively / passively (at TCP and ISO on TCP)</li> </ul>
	red	<ul style="list-style-type: none"> <li>• Connection is established actively / passively (at TCP and ISO on TCP)</li> </ul>

## ③ Details

Here you can find detailed information on the selected connection.

## Reference

The explanation of the error messages that may be reported when a connection is lost or when an attempt to establish a connection fails, can be found in the online Help for STEP 7.

### 3.7.4.7 Topology

#### Topology of the PROFINET nodes

The "Topology" web page gives you information about the topological structure and the status of the PROFINET devices in your PROFINET IO system.

There are three tabs for the following views:

- Graphical view (setpoint and actual topology)
- Tabular view (only actual topology)
- Status overview (omitting the topological relationships)

The tabular view and the status overview can be printed out. Before printing, use the print preview of your browser and, if necessary, correct the format.

#### Set topology

Displays the topological structure configured using the STEP 7 Topology-Editor for the configured PROFINET devices in a PROFINET IO system, with the corresponding status displays. Adjacent PROFINET devices are also shown, insofar as their topological structure was also configured. For these, however, no status display is shown.

The topological assignment of defective PROFINET devices, together with setpoint-actual variations and the display of transposed ports can also be seen in this view.

---

#### Note

In the following scenarios, the configured setpoint topology is always shown:

- When the "Topology" web page is called via the navigation bar
  - during switch from the "Module status" web page, from the overview of the PROFINET IO devices, via the "Topology" link to the "Topology" web page
- 

If no design topology is configured, by default the actual topology is called up.

#### Actual topology

Displays the current topological structure of the "configured" PROFINET devices of a PROFINET IO system and the directly adjacent non-configured PROFINET devices insofar as they can be determined (display of the relationships to adjacent devices, insofar as they can be determined; for these adjacent PROFINET devices, however, no status display is shown).



## Topology - graphical view

### Requirements

For error-free use of the topology, the following preconditions must be satisfied:

- The language settings have been made.
- The topological interconnection of the ports has been configured in the topology editor of STEP 7. (Precondition for the display of the setpoint topology and the corresponding topological setpoint connections).
- The project has been implemented in HW config.
- "Report system errors" has been generated.
- The project has been fully downloaded (configuration and program).

### Setpoint topology and actual topology - graphical view

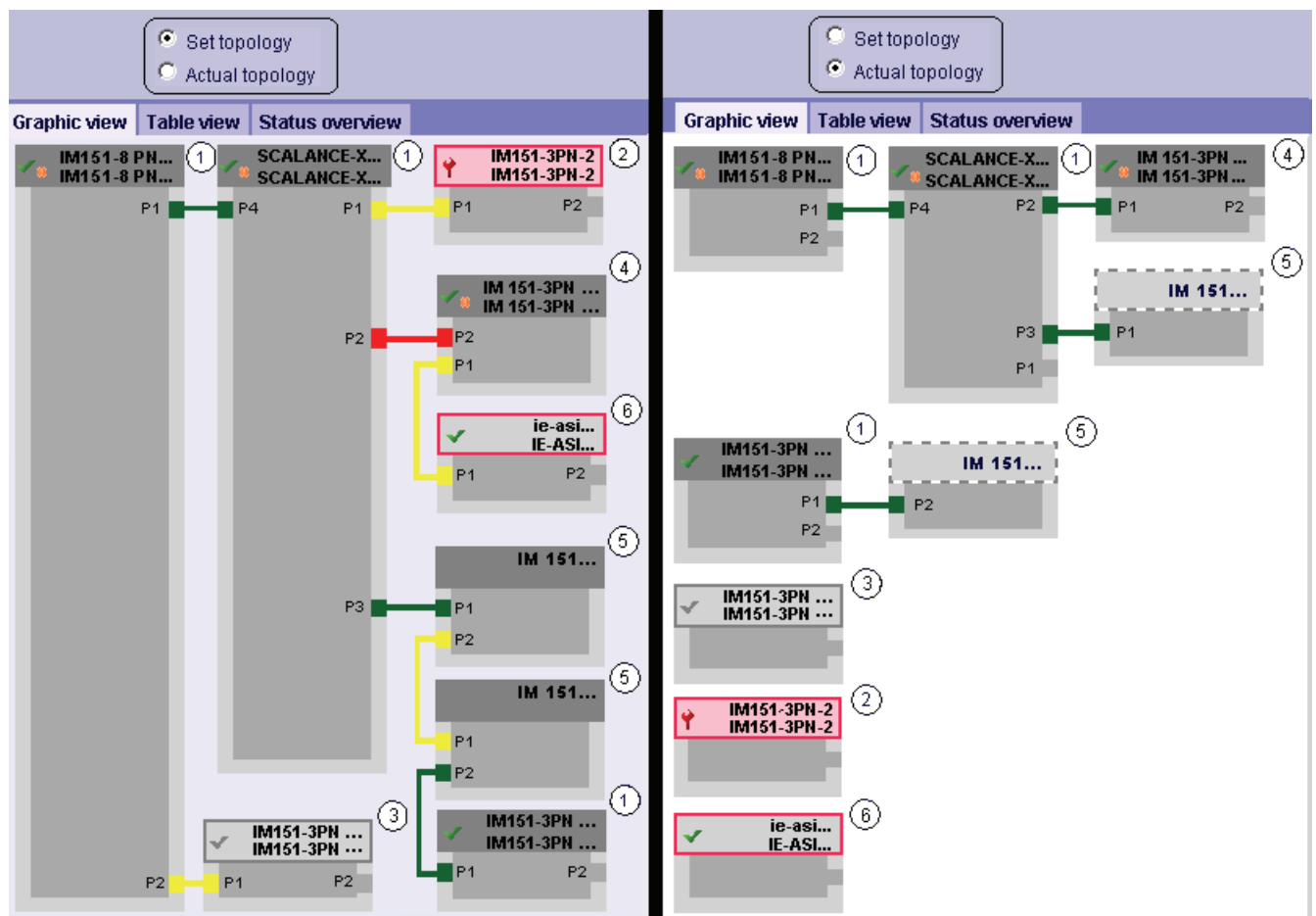

Figure 3-14 Graphical view - setpoint and actual topology

Meaning of the colored connections in the setpoint/actual topology:

Connection	Meaning	
	Set topology	Actual topology
green	The current actual connection corresponds to the configured setpoint connection.	Recognized connections
red	The current actual connection does not correspond to the configured setpoint connection (e.g. ports transposed).	-
Yellow	The connection cannot be diagnosed. Causes: <ul style="list-style-type: none"> <li>• The communication with a device has been lost (e.g. cable unplugged),</li> <li>• this is a connection to a passive component,</li> <li>• this is a connection to devices/PROFINET devices of another IO controller or IO subsystem.</li> </ul>	-

**① Configured and accessible PROFINET nodes**

Configured and accessible PROFINET nodes are displayed in dark gray. Connections show through which ports the PROFINET nodes of a CPU are connected.

**② Configured but inaccessible PROFINET nodes**

Pink with a red border shows the configured but inaccessible PROFINET nodes (e.g. device defective, cable unplugged)

**③ Deactivated nodes**

Pale gray shows all deactivated configured PROFINET nodes.

**④ Transposed ports**

Transposed ports are shown red in the setpoint topology view. The actual topology shows the ports actually connected, and the setpoint topology shows the configured setpoint connection.

### ⑤ PROFINET devices in another PROFINET IO subsystem

- In the setpoint topology:

A PROFINET device in another PROFINET IO subsystem is shown with a green connection (with in the case of transposed ports a red connection), if it adjoins directly a configured accessible PROFINET device ① and is itself also accessible.

If the PROFINET device in another PROFINET IO subsystem is not accessible, a yellow connection line is shown.

The connection between two PROFINET devices which both belong to another PROFINET IO subsystem, cannot be determined and is always shown yellow.

- In the actual topology:

A PROFINET device in another PROFINET IO subsystem is shown only if it directly adjoins a configured PROFINET device. Such devices are shown pale gray and with a dashed line.

For PROFINET devices in another PROFINET IO subsystem, **no** status display is shown in the device head.

### ⑥ Displaying faulty neighbor relationships

The nodes whose neighbor relationships are incomplete or can only be read out with an error are displayed in pale gray with a red border.

---



#### Note

#### Displaying faulty neighbor relationships

A firmware update of the affected component is required.

---

### Views for changes to the structure

- If a device becomes defective, that device remains in the same place on the "Setpoint Topology" view, but the device head is bordered with red and displays a red screwdriver .
- If a device becomes defective, that device is segregated to a lower area on the "Actual Topology" view, and the device head is bordered with red and displays a red screwdriver .

### Link between the "Topology" and "Module state" Web pages

The two web pages, "Topology" and "Module status", are linked. Clicking on the head of a configured module in a topology view skips automatically to this module on the "Module status" web page.

See also Section "Module status (Page 66)".

### Topology - tabular view

The "Tabular view" always shows the "Actual topology".

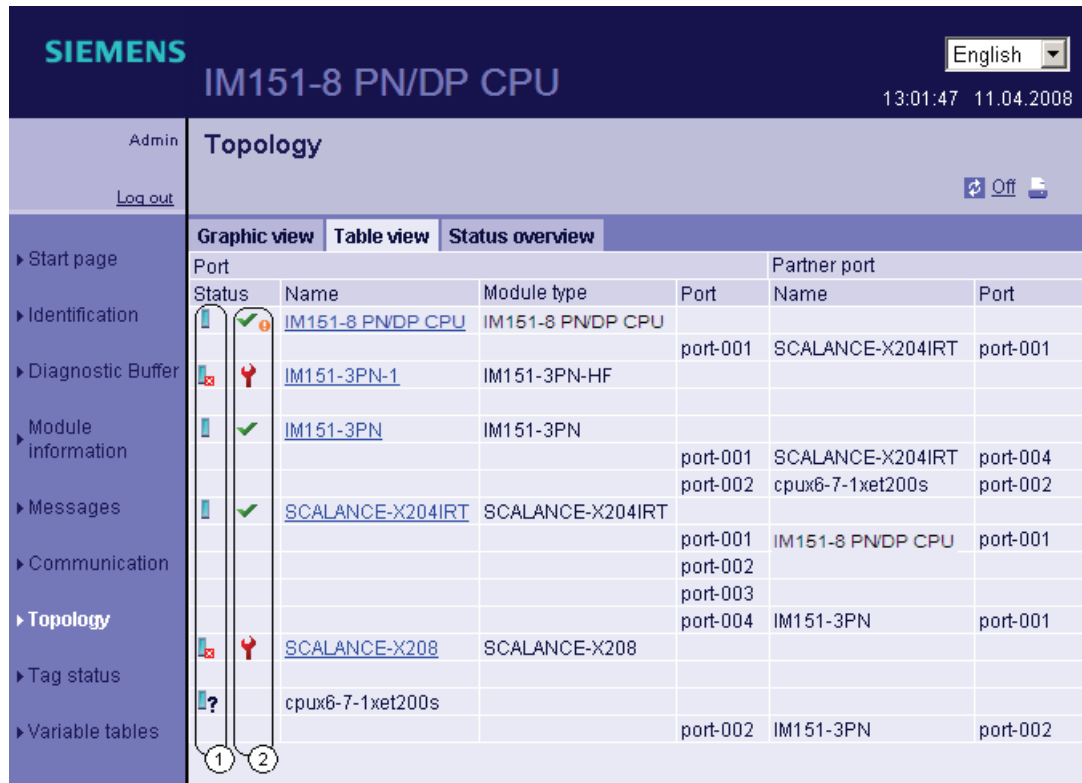









Figure 3-15 Topology - tabular view

### ① Meaning of the symbols relating to the status of the PROFINET nodes

Symbol	Meaning
	Configured and accessible PROFINET nodes
	Unconfigured and accessible PROFINET nodes
	Configured but inaccessible PROFINET nodes
	Nodes for which neighbor relations cannot be determined or for which the neighbor relationship could not be read out completely or only with errors

## ① Meaning of the symbols relating to the module status of the PROFINET nodes

Symbol	Color	Meaning
	green	Component OK
	gray	Disabled PROFIBUS slaves or PROFINET devices Requirement for support: <ul style="list-style-type: none"> <li>• IM151-8 PN/DP CPU <math>\geq</math> V3.2 and STEP 7 V5.5</li> <li>• Enabling/disabling the PROFIBUS slaves and PROFINET IO devices using SFC12 mode 3/4</li> <li>• In the "Report System Error" dialog, in the "Diagnostics support" tab, area "Status activated/deactivated", a check must be set in the "Device interrogation for status 'activated/deactivated' after CPU start-up" check box, optionally also in the "Generate alarm at change of status" check box.</li> </ul>
	black	Component cannot be accessed/Status cannot be determined <ul style="list-style-type: none"> <li>• The "Status cannot be determined" is, for example, always displayed in the STOP mode of the IM or during the initial evaluation of "Report system error" for all the configured I/O modules and I/O systems after the IM has been restarted.</li> <li>• However, this status can also be displayed temporarily during operation if a diagnostic interrupt burst occurs at all modules.</li> <li>• For modules of a subsystem that is connected to a CP, no status can be determined.</li> </ul>
	green	Maintenance required
	yellow	Maintenance requested
	red	Error - component failed or faulty
	-	Error in a lower module level

### Topology - status overview

The "Status overview" shows a clear representation of all PROFINET IO devices / PROFINET devices (without connection relationships) on one page. A quick error diagnostics is possible based on the symbols that show the module statuses.

Here, too, there is a link to the modules on the "Module status (Page 66)" web page.

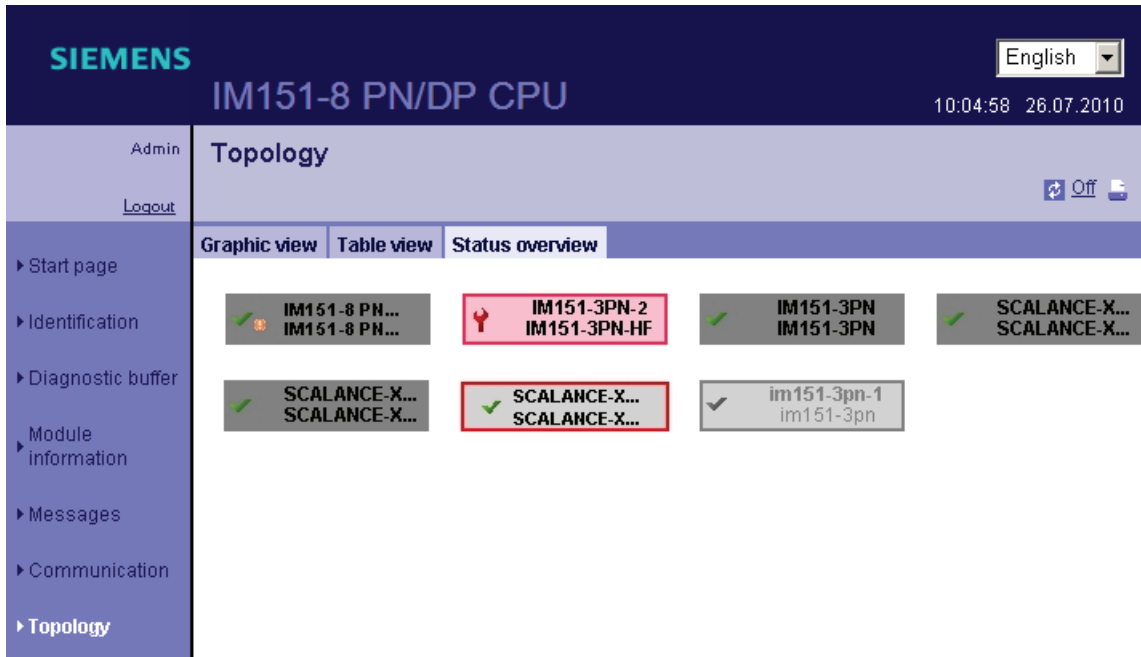

Figure 3-16 Topology - status overview

### 3.7.4.8 Variable status

#### Variable status

The variable status is displayed by the browser via the web page of the same name. You can monitor the status of up to 50 variables.

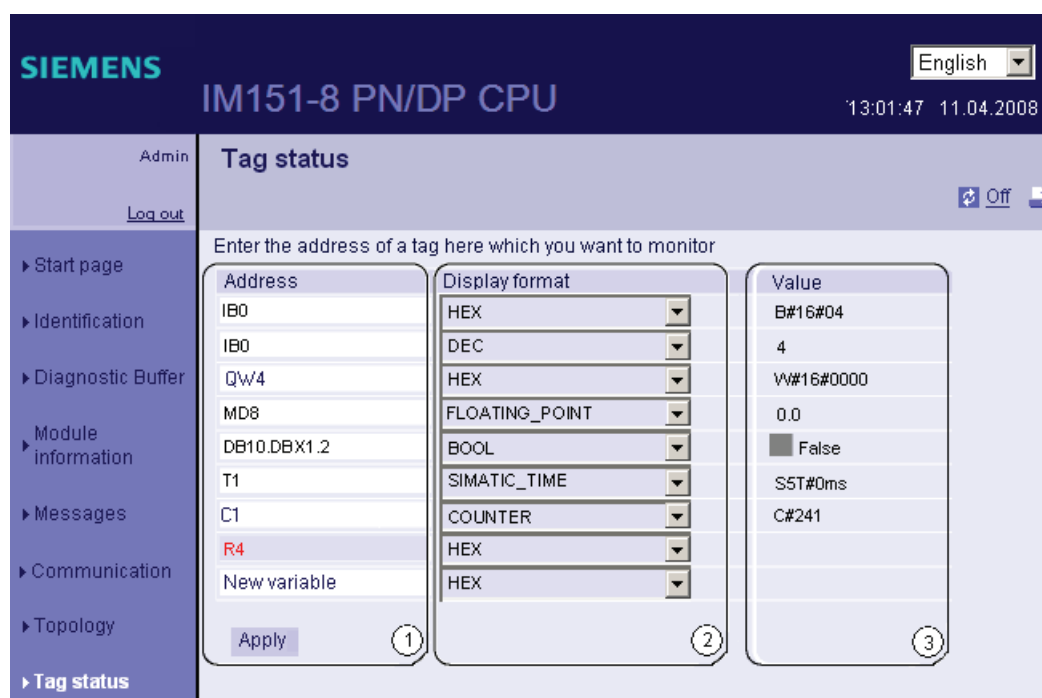

Figure 3-17 Variable status

#### ① "Address"

In the "Address" text box, enter the address of the operand whose behavior you wish to monitor. If you enter an invalid address, it is displayed in red.

#### ② "Display format"

Select the required display format for the variable from this drop-down list box. If the variable cannot be displayed in the required display format, it will be displayed in hexadecimal code.

#### ③ "Value"

This displays the value of the operand in the selected format.

### Point to note when changing between languages

You can change the language, e.g. from German to English, in the top right-hand corner. Please note that the mnemonic for German differs from that for the other languages. This means that the operand that you entered may have the wrong syntax when you change between languages. For example: ABxy rather than QBxy. Incorrect syntax is displayed in red in the browser.

### 3.7.4.9 Variable tables

#### Variable tables

The browser displays the content of the configured, web-compatible variable tables on the web page of the same name. You can monitor up to 200 variables with each variable table.

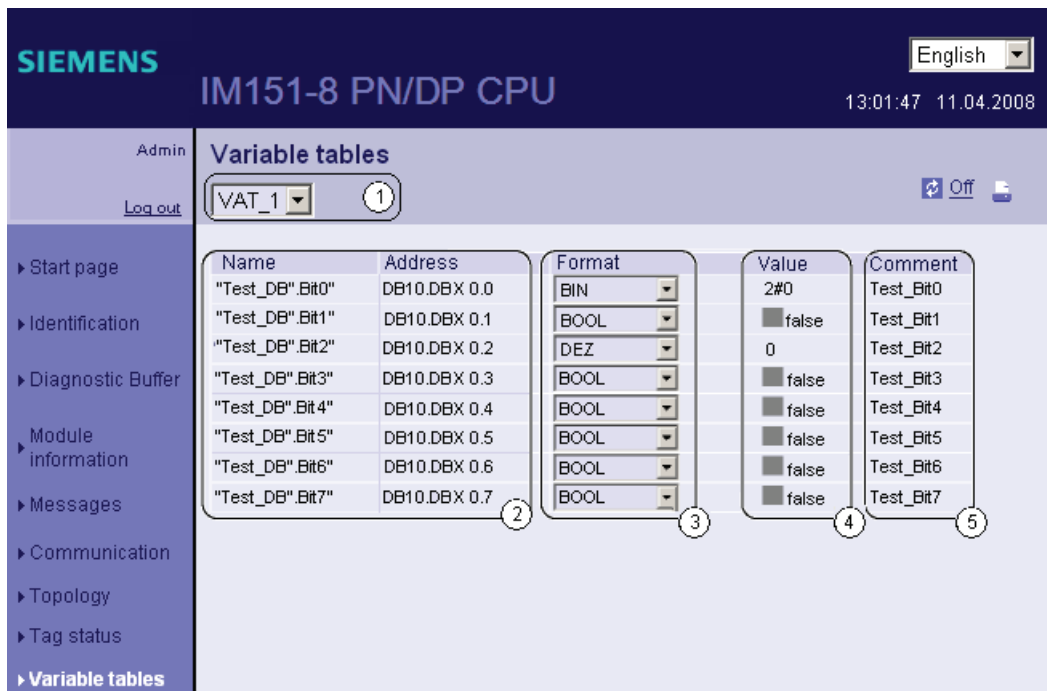

Figure 3-18 Variable tables

#### ① Selection

Select one of the configured variable tables from the drop-down box.

#### ② "Name" and "Address"

This info field displays the name of an operand and its address.



**③ "Format"**

Select the display format for the operand from this drop-down list box. The drop-down list box contains all the permitted display formats.

**④ "Value"**

This column shows the values in the display format.

**⑤ "Comment"**

The comment that you enter is displayed to make it easy to recognize the importance of an operand.

**Configuring variable tables for web servers**

The web server allows you to monitor up to 50 variable tables with up to 200 variables. As the available interface module memory is shared by messages and variables, the actually available number of variable tables may be reduced.

Example: The available memory is sufficient for around 400 messages and 50 variable tables with 100 variables (with symbol names, but without symbol comments).

If the permitted memory is exceeded by configured messages and variables, the variable tables displayed in the web browser will be incomplete. In this case, you will have to replace the memory needed by your messages and symbol comments. If at all possible, you should only use one language for the display.

You should also configure your variable tables with as few variables as possible, with short names and comments, in order to ensure that the variable tables are displayed in full by the web server and will also be updated faster than tables containing a large number of variables (limited memory).

### Creating a variable table for web servers

1. Create a variable table with *STEP 7*.
2. Open the properties dialog of the variable table and select the "General - Part 2" tab.
3. Activate the "Web server" check box.

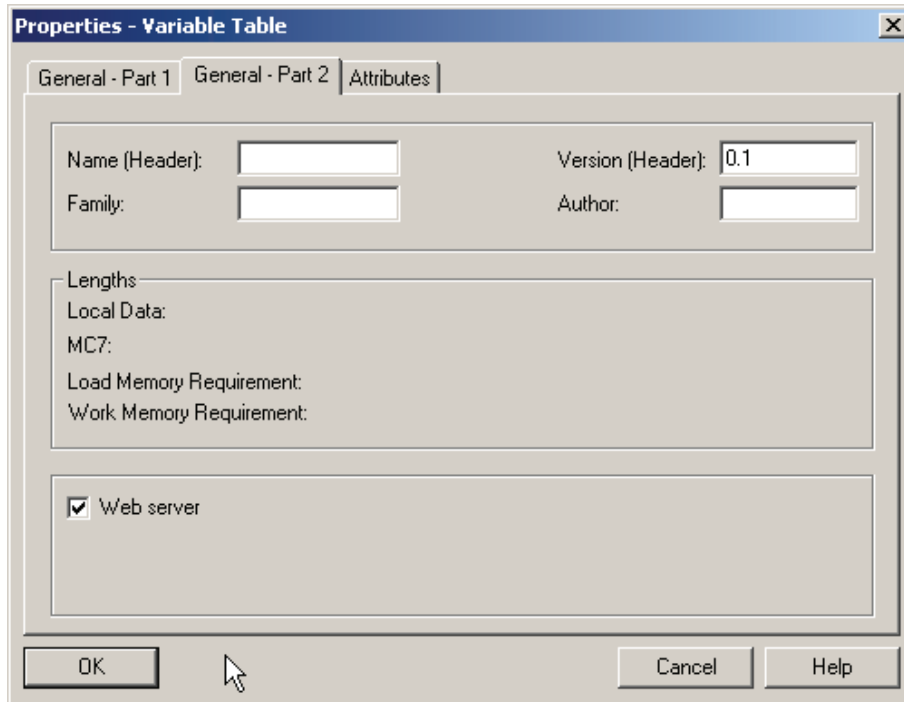

4. Save and compile the project and download the configuration data to the interface module.

### 3.7.4.10 User pages

#### User pages

On this Web page, you will find the link to your freely programmed user page.

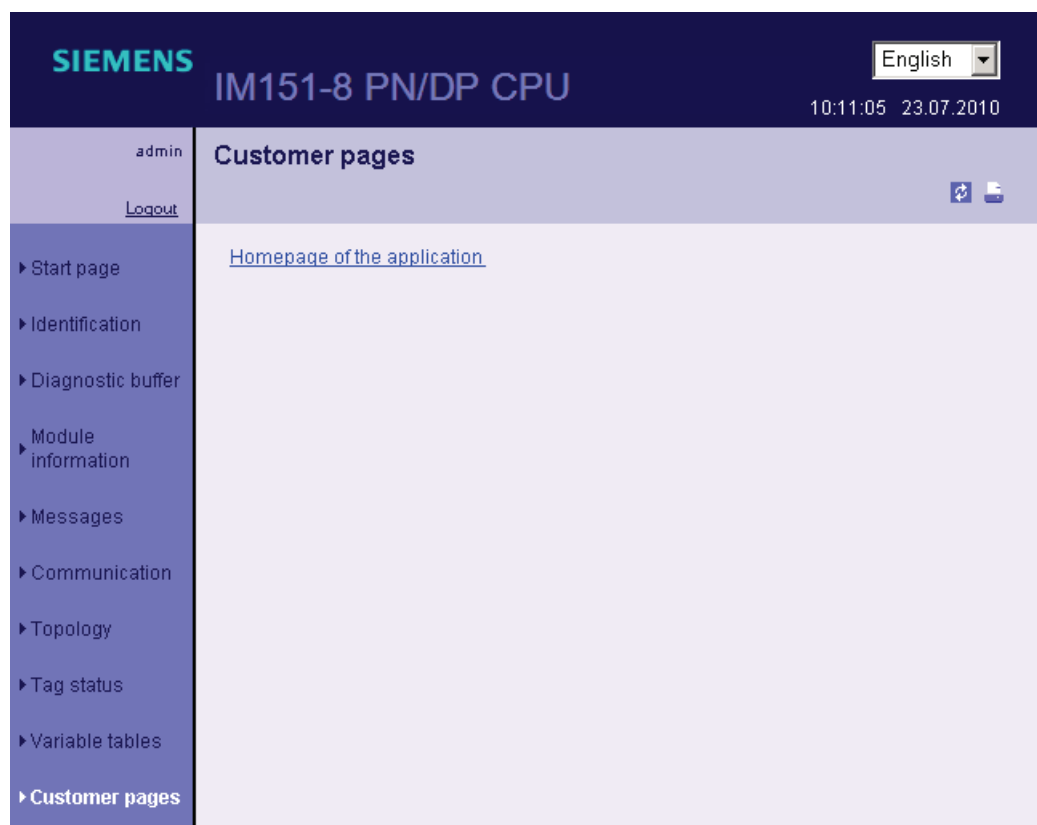

Figure 3-19 User pages

You can use the web server to create user-specific HTML pages which contain data from the CPU. For this purpose, you can use any web editor to create the web page, using the symbols from the STEP 7 user program. The Web2PLC program supplied with STEP 7 then converts the user page created into DBs. The DBs that are generated are downloaded to the CPU. The system function SFC 99 "WWW" links the user program to the internal web server on the CPU, and when SFC 99 "WWW" is called for the first time, the link to the user page is shown on the web page of the CPU. Clicking on the link starts the user page in a new window.

You can activate a maximum of two configured user pages concurrently.

## Requirements

- You have created the symbols for the input/output variables in your *STEP 7* project that you wish to use on your user page.
- In the properties dialog of the IM151-8 PN/DP CPU, under the "Web" tab, you have at least
  - activated the web server
  - entered a user in the user list
  - assigned this user (and any others) user read rights or read-write rights (see section "Settings in HW config, "Web" tab (Page 56)")
- You have performed the necessary settings for communications (IP address parameters, subnet mask, ...).
- You have saved and loaded the hardware configuration.
- You have created your user page by means of your chosen HTML editor:
  - automatic HTML pages, if control of the page structure is **not** desired by the user program (one-off call up of SFC 99 is required)
  - manual HTML pages, if control of the page structure is **not** desired by the user program (cyclical call up of SFC 99 is required)
- You have installed the Web2PLC program supplied on the CD for the *STEP 7* (installation path: CD2: \Optional Components\S7 Web2PLC)

## Creating a dynamized user page

To dynamize your user page you must use AWP (Advanced Web Programming) commands on your HTML user page. AWP commands are a command set from Siemens, by means of which CPU information can be accessed. The AWP- commands are described in the *online Help for Web2PLC*.

## Procedure

1. Select the directory "Blocks" in the SIMATIC Manager in the S7 program for the IM151-8 PN/DP CPU, and from the context menu select "S7-Web2PLC".  
The program S7-Web2PLC starts.
2. Select the **File > New Project...** menu command and enter the desired project name.
3. Select the **File > Change Project Settings...** menu command.  
The configuration settings dialog opens.
4. In the "General" tab, enter the path of your HTML folder.
5. Enter the HTML file to be started as the user page, and the desired name of the application.  
Confirm with **OK**. The dialog for the STEP 7 / web project opens.
6. In the "STEP 7" tab enter the desired DB numbers (default setting 333 and 334)  
Confirm with **OK**. The dialog for the STEP 7 / Web project opens.
7. Open your user page with the HTML editor and reference the variables that you wish to use in your user page, using the AWP commands and the symbolic names from STEP 7.  
To do this, use the online Help for the Web2PLC.

8. Once the HTML page has been edited and saved, return to your S7 Web2PLC project. Click successively on the following buttons:

- "Export symbols"
- "Generate DB source"
- "Compile DB source"

The corresponding actions are performed and a control DB ("Web DB") and at least one fragment DB in the S7 program of the IM151-8 PN/DP CPU, directory "Blocks", are created.

9. Click on the "Load to CPU" button to load the DBs into the CPU.

---

**Note**

During this procedure the IM should be in STOP mode. If the WEB DBs are transferred in Run mode, synchronization errors can occur during the loading period when access is gained from the user program to the control DB.

---

**Reference**

Further information on this and a description of the areas that can be modified can be found in the *online Help for the Web2PLC*.

For more detailed information on the SFC 99 block, refer to the *online Help for STEP 7*.



# PROFINET

## 4.1 Communication by means of PROFINET

### 4.1.1 Introduction

#### What is PROFINET?

Within the framework of Totally Integrated Automation (TIA), PROFINET represents a consequent enhancement of:

- PROFIBUS DP, the established field bus, and
- Industrial Ethernet, the communication bus for the cell level

Experience gained from both systems was and is being integrated into PROFINET.

PROFINET is an Ethernet-based automation standard of PROFIBUS International (previously PROFIBUS Users Organization e.V.), and defines a multi-vendor communication, automation, and engineering model. PROFINET has been part of the standard IEC 61158 since 2003.

#### Objectives in PROFINET

The objectives in PROFINET are:

- Open Ethernet Standard for automation based on Industrial Ethernet.  
Although Industrial Ethernet and Standard Ethernet components can be used together, the Industrial Ethernet devices are more sturdy and therefore better suited for industrial environments (temperature, immunity to interference, etc.)
- Using TCP / IP and IT standards
- Automation with real-time Ethernet
- Total integration of field bus systems

### Implementation of PROFINET in SIMATIC

We have integrated PROFINET as follows:

- We have implemented communication between field devices in SIMATIC with **PROFINET IO**.
- In SIMATIC, communication between controllers as components in distributed systems is implemented with **PROFINET CBA** (Component based Automation).
- Installation engineering and network components are available in SIMATIC NET.
- Established IT standards from the Office environment (e.g., SNMP=Simple Network Management Protocol for network parameter assignment and diagnosis) are used for remote maintenance and network diagnostics.

### Documentation from PROFIBUS International on the Internet

At the website of PROFIBUS International (previously PROFIBUS User Organization, PNO), you will find numerous documents on the topic of PROFINET. "PROFINET (<http://www.profinet.com>)"

For more information, go to: "Siemens PROFINET (<http://www.siemens.com/profinet>)"

#### 4.1.2 PROFINET IO and PROFINET CBA

##### What is PROFINET IO?

Within the framework of PROFINET, PROFINET IO is a communication concept for the implementation of modular, distributed applications.

PROFINET IO allows you to create automation solutions, which are familiar to you from PROFIBUS.

This means that you have the same application view in *STEP 7*, regardless of whether you are configuring PROFINET or PROFIBUS devices.

##### What is PROFINET CBA (Component Based Automation)?

Within the framework of PROFINET, PROFINET CBA is an automation concept for the implementation of applications with distributed intelligence.

PROFINET CBA lets you create distributed automation solutions, based on default components and partial solutions.

Component Based Automation allows you to use complete technological modules as standardized components in large systems.

The components are also created in an engineering tool which may differ from vendor to vendor. Components of SIMATIC devices are created, for example, with *STEP 7*.



## Extent of PROFINET CBA and PROFINET IO

PROFINET IO and CBA represent two different views of automation devices on Industrial Ethernet.

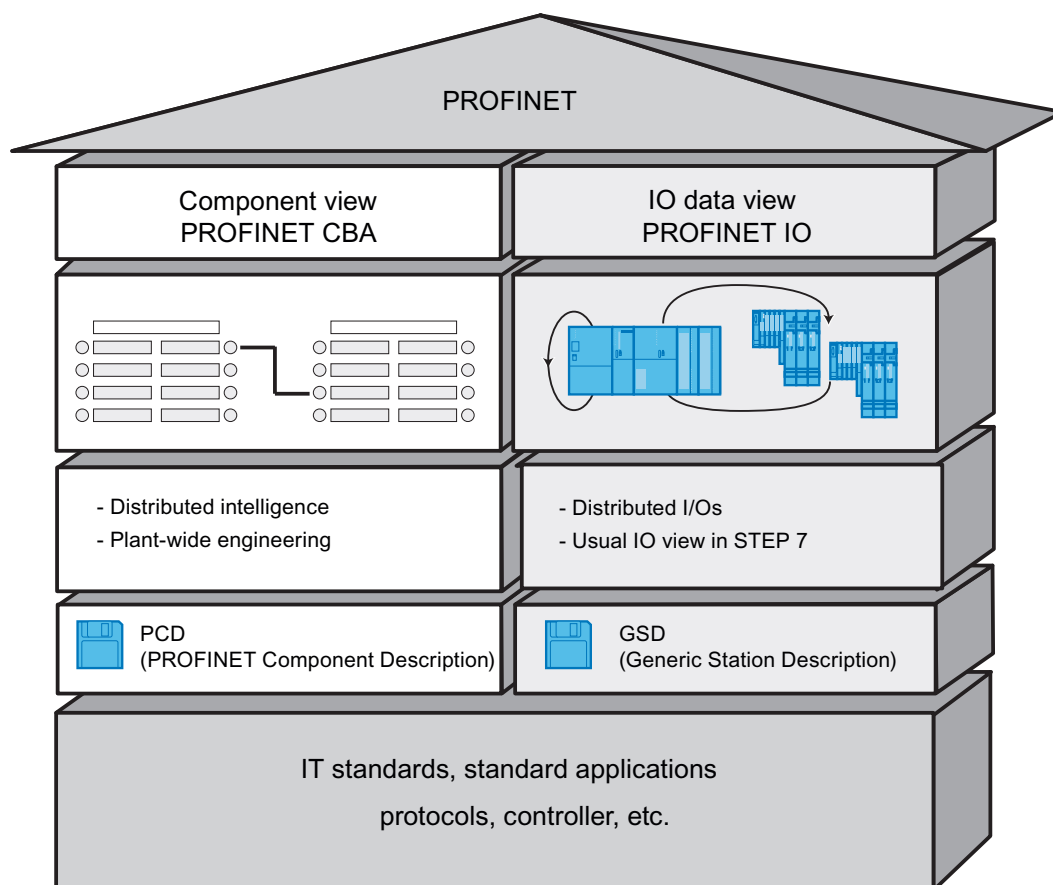

Figure 4-1 Extent of PROFINET IO and Component-Based Automation

Component Based Automation divides the entire system into various functions. These functions are configured and programmed.

PROFINET IO provides you with a view of the system that is very similar to the view obtained in PROFIBUS. You continue to configure and program the individual automation devices.

## Reference

### Additional information

- Details on PROFINET IO and PROFINET CBA are available in the PROFINET System Description. (<http://support.automation.siemens.com/WW/view/en/19292127>)
- Differences between and common properties of the PROFIBUS DP and PROFINET IO are described in the From PROFIBUS DP to PROFINET IO (<http://support.automation.siemens.com/WW/view/en/19289930>) Programming Manual.
- For additional information on PROFINET CBA, refer to the documentation on SIMATIC iMAP and Component Based Automation.

### 4.1.3 PROFINET IO System

#### Functions of PROFINET IO

The following graphic shows the new functions in PROFINET IO.

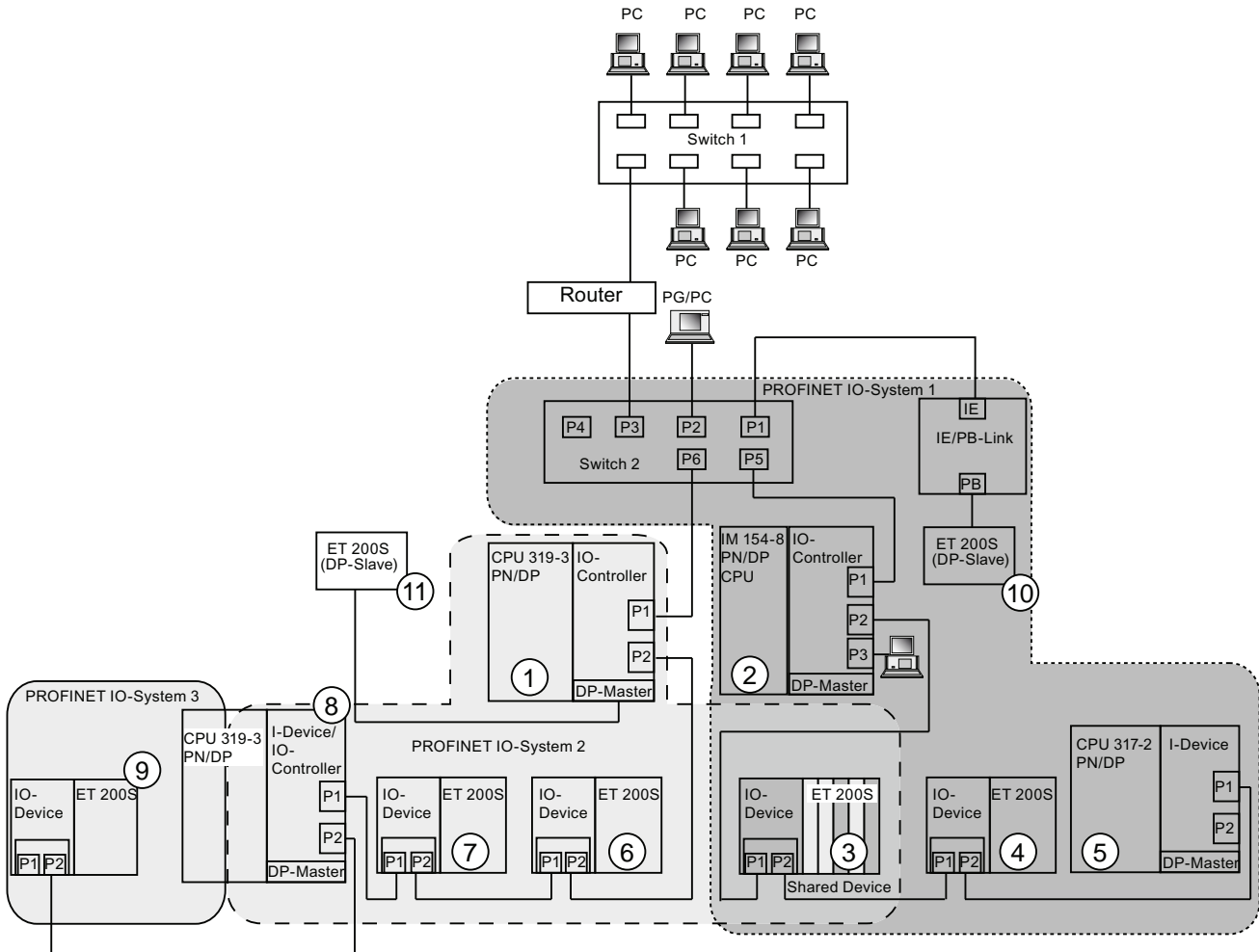

Figure 4-2 PROFINET IO

The graphic shows	Examples of connection paths
The connection of company network and field level	You can access devices at the field level from PCs in your company network Example: <ul style="list-style-type: none"> <li>PC - Switch 1 - Router - Switch 2 - CPU 319-3 PN/DP ①.</li> </ul>
Connections between the automation system and field level	You can also access other areas on the Industrial Ethernet from a programming device at the field level. Example: <ul style="list-style-type: none"> <li>PD - integrated switch IM 154-8 PN//DP CPU ② - Switch 2 - integrated switch CPU 319-3 PN/DP ① - integrated switch IO device ET 200S ⑥ - on IO device ET 200S ⑦.</li> </ul>
The IO controller of the CPU IM 154-8 PN/DP CPU ② powers the PROFINET IO system 1 and directly controls devices on the Industrial Ethernet and on the PROFIBUS	At this point, you can see IO features between the IO controller, I device and IO device(s) on the Industrial Ethernet: <ul style="list-style-type: none"> <li>The IM 154-8 PN/DP CPU ② is the IO controller for the two IO devices ET 200S ③ and ET 200 S ④, for the switch 2 and also for the I device CPU 317-2 PN/DP ⑤.</li> <li>The IO device ET200S ③ is thus operated as a shared device, so that the IM 154-8 CPU ② as controller can access only those (sub)modules of this IO device which are assigned to it as the controller.</li> <li>Via the IE/PB link, the IM 154-8 CPU ② is also the IO controller for the ET 200 (DP slave) ⑩.</li> </ul>
The CPU 319-3 PN/DP ① powers the PROFINET system 2 as its IO controller and is at the same time the DP master on PROFIBUS. As well as other IO devices, this controller also operates a CPU 319-3 PN/DP ⑧ as an I device, which in turn powers a lower level PROFINET system as the IO controller.	Here you can see that a CPU can be both the IO controller for an IO device and the DP master for a DP slave: <ul style="list-style-type: none"> <li>The CPU 319-3 PN/DP ① is the IO controller for the two IO devices ET 200S ⑥ and ET 200 S ⑦ and also for the I device CPU 319-3 PN/DP ⑧.</li> <li>Furthermore, the CPU319-3 PN/DP ① shares the IO device ET 200S operated as a shared device ③ with the IO controller IM 154-8 PN/DP CPU ②, so that the CPU 319-3 PN/DP ① as controller can access only those (sub)modules of this IO device, which are assigned to it as the controller.</li> <li>The CPU 319-3 ⑧, which is operated as an I device at the CPU 319-3 PN/DP ①, is also at the same time an IO controller and powers its own PROFINET system 3 on which the IO device ET 200S ⑨ is operated.</li> <li>The CPU 319-3 PN/DP ① is the DP master for one DP slave ⑪. The DP slave ⑪ is assigned locally to the CPU 319-3 PN/DP ① and is not visible on the Industrial Ethernet.</li> </ul>

## Reference

You will find further information about PROFINET in the documents listed below:

- in the system description PROFINET (<http://support.automation.siemens.com/WW/view/en/19292127>).
- In the programming manual From PROFIBUS DP to PROFINET IO. (<http://support.automation.siemens.com/WW/view/en/19289930>) programming manual. This manual also provides a clear overview of the new PROFINET blocks and system status lists.

**See also**

PROFINET (PN) (Page 27)

**4.1.4 Blocks for PROFINET IO**

**Content of this Section**

This section explains the following:

- Which blocks are intended for PROFINET
- Which blocks are intended for PROFIBUS DP
- Which blocks are intended for both PROFINET IO and PROFIBUS DP

**Compatibility of the New Blocks**

For PROFINET IO, it was necessary to create some new blocks, among other things, because larger configurations are now possible with PROFINET. You can also use the new blocks with PROFIBUS.

**Comparison of the System and Standard Functions of PROFINET IO and PROFIBUS DP**

For the IM 151-8 PN/DP CPU interface module with an integrated PROFINET interface, the table below provides an overview of:

- System and standard functions for SIMATIC that you may need to replace when converting from PROFIBUS DP to PROFINET IO.
- New system and standard functions

Table 4- 1 New System and Standard Functions/System and Standard Functions to be Replaced

Blocks	PROFINET IO	PROFIBUS DP
SFC 5 (determine logical start address of a module)	No (replacement: SFC70)	Yes
SFC 12 (deactivation and activation of DP slaves/IO devices)	Yes	Yes
SFC 13 (read diagnostic data of a DP slave)	No Substitute: • Event-related: SFB 54 • State-related: SFB 52	Yes
SFC 49 (determine the slot belonging to a logical address)	No Substitute: SFC 71	Yes
SFC 58/59 (write/read data record in I/O)	No Substitute: SFB 53/52	Yes You should use SFB 52 / 53 under DPV1.

Blocks	PROFINET IO	PROFIBUS DP
SFC 70 (determine start address of a module)	Yes	Yes
SFC 71 (determine the slot belonging to a logical address)	Yes	Yes
SFC 102 (read predefined parameters)	No Substitute: SFB 81	Yes
SFB 52/53 (read/write data record)	Yes	Yes
SFB 54 (evaluate interrupt)	Yes	Yes
SFB 73 ((PROFInergy) data blocks in the I device received by the higher level controller)	Yes	No
SFB 74 ((PROFInergy) data blocks in the I device available to the higher level controller)	Yes	No
SFB 81 (read predefined parameters)	Yes	Yes
SFB 104 (assignment of the IP suite and / or the device name from the user program)	Yes	No

The following table provides you with an overview of the system and standard functions for SIMATIC, whose functionality must be implemented by other functions when converting from PROFIBUS DP to PROFINET IO.

Table 4- 2 System and Standard Functions in PROFIBUS DP that must be Implemented with Different Functions in PROFINET IO

Blocks	PROFINET IO	PROFIBUS DP
SFC 55 (write dynamic parameters)	No Replicate via SFB 53	Yes
SFC 56 (write predefined parameters)	No Replicate via SFB 81 and SFB 53	Yes
SFC 57 (assign module parameters)	No Replicate via SFB 81 and SFB 53	Yes

You cannot use the following SIMATIC system and standard functions with PROFINET IO:

- SFC 11 (synchronize groups of DP slaves)
- SFC 72 (read data from a communication partner within local S7 station)
- SFC 73 (write data to a communication partner within local S7 station)
- SFC 74 (cancel an existing connection to a communication partner within local S7 station)
- SFC 103 (determine the bus topology in a DP master system)

**Comparison of the Organization Blocks of PROFINET IO and PROFIBUS DP**

Here, there are changes to OB 83 and OB 86, as shown in the following table.

Table 4- 3 OBs in PROFINET IO and PROFIBUS DP

Blocks	PROFINET IO	PROFIBUS DP
OB 83 (removal and insertion of modules during operation)	New error information	The removal and insertion of modules during operation is signaled by slaves added using a GSD file by means of a diagnostic interrupt, in other words OB 82.  In the case of S7 slaves, a swapping interrupt causes a CPU stop to be reported and OB 86 to be called.
OB 83 Return of submodule alarm for submodules in the transfer areas of an I device	corresponding info for the submodules	Not applicable
OB 86 (CPU stop)	New error information	Unchanged
OB 86 (partial CPU stop / partial CPU restart)	may occur when used as a shared I device	Not applicable

**Detailed Information**

For detailed descriptions of the individual blocks, refer to the *System and Standard Functions for S7-300/400* manual.

## 4.2 Isochronous real time communication

Synchronized transmission procedure for the cyclic exchange of IRT data between PROFINET devices. A reserved bandwidth is available within the send cycle for IRT IO data.

The reserved bandwidth ensures that the IRT data can be transmitted at reserved, synchronized intervals while remaining uninfluenced even by other greater network loads (e.g. TCP / IP communication or additional real-time communication).

PROFINET with IRT can be operated using either of the two following options:

- IRT option "high flexibility":  
Maximum flexibility in planning and extending the system.  
Topological configuration is **not** required.
- IRT option "high performance":  
Topological configuration is required.

---

### Note

#### **IO controller as a sync master at IRT communication with the IRT option "high performance"**

We recommend also operating the IO controller as a Sync-Master if you configure the IRT communication with the option "high performance". Otherwise, IRT and RT configured IO devices may fail if the sync master fails.

---

### Additional information

For further information about configuring PROFINET devices, refer to the STEP 7 online Help and the PROFINET System Description (<http://support.automation.siemens.com/WW/view/en/19292127>).

## 4.3 Prioritized startup

Prioritized startup describes the PROFINET functionality for the acceleration of IO devices (distributed I/O) in a PROFINET IO system with RT and IRT communication.

The function shortens the time required by the respective configured IO devices to reach the cyclic user data communication in the following cases:

- After restoration of power (not for a CPU that is operated as an I device with prioritized start-up)
- After a CPU has restarted
- After IO Devices have been activated

---

### Note

#### **Startup times**

The startup time depends on the number and type of modules.

---

**Note****Prioritized startup and media redundancy**

The inclusion of a IO device with prioritized startup in a ring topology with media redundancy is not possible.

---

**Additional information**

For additional information, refer to the STEP 7 online help and the PROFINET System Description (<http://support.automation.siemens.com/WW/view/en/19292127>).

## 4.4 Device replacement without removable media / PD

IO devices with this function can be exchanged easily:

- A removable medium (such as Micro Memory Card) with stored device name is not required.
- The device name does not have to be assigned with the PD.

The substituted IO device is given a device name by the IO controller and not by the removable media or the PD. To do this, the IO controller uses the configured topology and the neighborhood classifications established from the IO devices. In doing so, the configured set topology must agree with the actual topology.

Reset the IO devices, which were already in operation, back to the factory settings before using them again.

**Additional information**

For additional information, refer to the STEP 7 online help and the PROFINET System Description (<http://support.automation.siemens.com/WW/view/en/19292127>).



## 4.5 IO devices that can be switched during operation

Functionality of a PROFINET device. If the IO controller and IO devices support this functionality, "switchable partner ports" of different devices can be assigned to an IO device port by means of configuration, so that communication with each of these switchable IO devices is possible at a particular time via the IO device port. However, only the switchable device that is currently being communicated with may be physically connected to the switchable port.

---

### Note

The ports of a CPU can be assigned as "switchable partner ports" only if the CPU is being operated as an I device. This is not the case, if it is operated as an IO controller.

---

### Additional information

For additional information, refer to the STEP 7 online help and the PROFINET System Description (<http://support.automation.siemens.com/WW/view/en/19292127>).

## 4.6 Isochronous mode

Process data, transfer cycle via PROFINET IO and user program are synchronized with each other to achieve the highest deterministics. The input and output data of distributed I/O devices in the system are detected and output simultaneously. The constant bus cycle times of the PROFINET IO cycle forms the clock generator for it.

---

### Note

**The following components cannot be operated in isochronous mode:**

- A shared device.
  - An I device at the higher-level IO controller
- 

---

### Note

#### Constraints on the send clocks for isochronous applications

Isochronous operation can be performed by the IM 151-8 PN/DP CPU when the send clock is  $\geq 1$  ms. Depending on the size of the user data and the topology, it may be necessary to increase the application cycle factor or the send clock, in order to satisfy the timing requirements.

---

### Additional information

For additional information, refer to the STEP 7 online help and the PROFINET System Description (<http://support.automation.siemens.com/WW/view/en/19292127>).

## 4.7 I-Device

The "I-Device" (intelligent IO device) functionality of an IM151-8 PN/DP CPU permits the exchange of data with an IO controller, thereby allowing the IM151-8 PN/DP CPU, for example, to be used as an intelligent pre-processing unit for subprocesses. For this the I device is linked in the role of an IO device to a "higher level" IO controller.

The pre-processing is performed by the user program in the IM151-8 PN/DP CPU with the I device functionality. The centralized or decentralized (PROFINET IO or PROFIBUS DP) process values are pre-processed by the user program and delivered to a higher level CPU by a PROFINET IO device interface of the CPU.

---

### Note

#### Isosynchronous mode

An I device at the higher-level IO controller cannot be operated isochronously.

---

### Combination of functionalities

A CPU that is operated as an I device at a "higher-level" IO controller can operate in its own right as an IO controller and thus operate IO devices in a lower-level subnet.

An I device can also be operated as a shared device.

### Transfer areas

Communication between an IO controller and I device is established via the configured submodules of a transfer area. The transfer of user data is thus performed consistently in relation to the submodules.

There are two types of transfer areas:

- **Application transfer areas** form the interface for the user data transfer between the higher-level IO controller and the user program of the I device CPU. Inputs are processed in the user program and outputs are the result of processing in the user program.
- **I/O transfer areas** deliver data from higher-level IO controllers to I/O devices or vice versa. No values are processed in the I device.

### Special considerations when using I/O transfer areas

Information on the behavior within the IO controller and the I device during processing, diagnostics, insert/remove module interrupts and load voltage diagnostics of modules, that are configured in the I/O transfer area of an I device can be found in the PROFINET System Description. Section "Diagnostics and alarm behavior" and "Supplementary conditions for use of I devices".

### Additional information

Further information about the I device and configuration of an I device can be found in the STEP 7 online Help and the PROFINET System Description (<http://support.automation.siemens.com/WW/view/en/19292127>).

## 4.8 Shared Device

The "Shared Device" functionality permits the sub-modules of an IO device to be distributed between various IO controllers. An I device can also be operated as a shared device.

The IO controller and the shared device have to be located on the same Ethernet subnet so that the shared device function can be used.

The IO controllers can be located in the same STEP 7 project or in different STEP 7 projects. If they are located in the same STEP 7 project, the consistency checking is performed automatically.

---

**Note**

A shared device cannot be operated isochronously.

---

**Note**

Please note that power modules and electronics modules of a potential group of a shared IO device (such as an ET200S) must be assigned to the same IO controller, so that a loss of load voltage can be diagnosed.

---

### Additional information

Further information about the shared device and configuration can be found in the STEP 7 online Help and the PROFINET System Description (<http://support.automation.siemens.com/WW/view/en/19292127>).

## 4.9 Media redundancy

Function for ensuring the network and system availability. Redundant transmission links (ring topology) ensure that an alternative communication path is made available if a transmission link fails.

For the IO devices, switches and CPUs from V3.2 onward, the media redundancy protocol (MRP) can be activated, which is part of the PROFINET standardization in accordance with IEC 61158.

### Structure of a ring topology

To set up a ring topology with media redundancy, you bring together at a single device the two free ends of a linear bus topology. Closing the linear bus topology to form a ring is achieved with two ports (ring ports) of a device in the ring. For the IM 151-8 PN/DP CPU, two ring ports (port 1 and port 2) are available for selection and configuration.

On the module the ring ports are indicated by an "R" after the port number.

---

#### Note

##### **IRT communication / prioritized start-up**

If IRT communication or prioritized start-up is used, media redundancy is not supported.

---

### Additional information

For additional information, refer to the STEP 7 online help and the PROFINET System Description (<http://support.automation.siemens.com/WW/view/en/19292127>).

## Memory concept

### 5.1 Memory areas and retentive memory

#### 5.1.1 Memory areas of the IM 151-8 PN/DP CPU interface module

##### The three memory areas of your IM 151-8 PN/DP CPU interface module

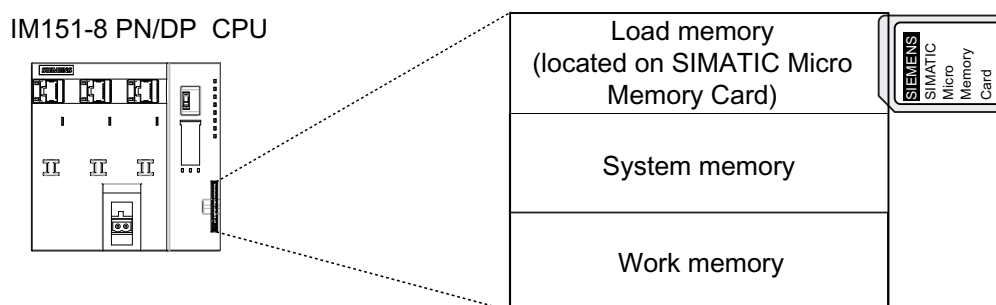

#### Load memory

The load memory is located on the SIMATIC Micro Memory Card. The size of the load memory corresponds exactly to the size of the SIMATIC Micro Memory Card. It is used to store code blocks, data blocks and system data (configuration, connections, module parameters, etc.). Blocks that are identified as non runtime-related are stored exclusively in load memory. You can also store all the configuration data for your project on the SIMATIC Micro Memory Card.

---

#### Note

User programs can only be downloaded and thus the IM151-8 PN/DP CPU interface module can only be used if the SIMATIC Micro Memory Card is inserted in the interface module.

---

#### System memory

The system memory is integrated in the IM151-8 PN/DP CPU interface module and cannot be extended.

It contains

- The address areas for address area memory bits, timers and counters
- The process image of the I/Os
- Local data

## Work memory

The working memory is integrated in the IM 151-8 PN/DP CPU interface module and cannot be extended. It is used to run the code and process user program data. Programs only run in work memory and system memory.

### 5.1.2 Retentivity of load memory, system memory and RAM

Your IM151-8 PN/DP CPU interface module is equipped with a maintenance-free retentive memory, i.e. its operation does not require a back-up battery. Data is kept in retentive memory across POWER OFF and restart (warm start).

#### Retentive data in load memory

Your program in the load memory is always retentive. It is stored on the SIMATIC Micro Memory Card, where it is protected against power failure or CPU memory restart

The configuration data for the interface of the IM151-8 PN/DP CPU interface module will be stored retentively in the load memory of an SDB.

#### Retentive data in system memory

In your configuration (IM151-8 PN/DP CPU interface module Properties, Retentivity tab), specify which parts of the bit memory, timers and counters should be kept retentive and which should be reinitialized to "0" on restart (warm restart).

The operating hour counter is usually stored in the retentive memory area on the IM151-8 PN/DP CPU interface module.

Only the last 100 entries in the diagnostics buffer are retentive with POWER OFF / POWER ON.

#### Retentive data in RAM

Therefore, the contents of retentive DBs are always retentive at restart and POWER OFF / POWER ON. Retentive data blocks can be uploaded to the work memory in accordance with the maximum limit allowed by the work memory.

The IM 151-8 PN/DP CPU interface module also supports non-retentive DBs. Non-retentive DBs are initialized from the load memory with their initial values whenever a restart is performed or with POWER OFF / POWER ON. Non-retentive data blocks and code blocks can be loaded in accordance with the maximum work memory limit.

64 KB of RAM can be used for retentive data blocks in the IM 151-8 PN/DP CPU interface module.

#### See also

Properties of the SIMATIC Micro Memory Card (Page 116)

### 5.1.3 Retentivity of memory objects

#### Retentive behavior of the memory objects

The table below shows the retentive behavior of memory objects during specific operating state transitions.

Table 5- 1 Retentive behavior of the memory objects

Memory object	Operating state transition		
	POWER OFF / POWER ON	STOP → RUN	Memory reset
User program / data (load memory)	X	X	X
<ul style="list-style-type: none"> <li>Retentive behavior of the DBs for the IM 151-8 PN/DP CPU interface module</li> </ul>	Can be set in the Properties of the DBs in <i>STEP 7</i> .		–
Bit memory, timers and counters configured as retentive data	X	X	–
Diagnostics buffers, operating hour counters	X <sup>1</sup>	X	X
IP suite / device name of the PN interface	Depending on the type of assignment of IP address parameters and device names.	X	Depending on the type of assignment of IP address parameters and device names.
X = retentive; – = not retentive <sup>1</sup> Only the last 100 entries in the diagnostics buffer are retained in the event of a POWER OFF / POWER ON.			

#### Reference

More detailed information about assignment of IP address parameters and device names can be found in the section "Assignment of IP address parameters and the device name (Page 139)".

**Retentive behavior of a DB with the IM 151-8 PN/DP CPU interface module**

For the IM 151-8 PN/DP CPU interface module you can specify in *STEP 7* or via SFC 82 "CREA\_DBL" (parameter ATTRIB -> NON\_RETAIN bit), whether, in response to a POWER ON / OFF or RUN-STOP, a DB

- Keeps the actual values (retentive DB), or
- Accepts the initial values from load memory (non-retentive DB)

Table 5- 2 Retentive behavior of the DB with the IM 151-8 PN/DP CPU interface module

After a POWER OFF / POWER ON or restart of the IM 151-8 PN/DP CPU interface module, the DB should...	
Receive the initial values (non-retentive DB)	Retain the last actual values (retentive DB)
Reason: After a POWER OFF / POWER ON and restart (STOP-RUN) of the IM 151-8 PN/DP CPU interface module, the actual values of the DB are non-retentive. The DB receives the start values from load memory.	Reason: After a POWER OFF / POWER ON and restart (STOP-RUN) of the IM 151-8 PN/DP CPU interface module, the actual values of the DB are retained.
Requirement in <i>STEP 7</i> : <ul style="list-style-type: none"> <li>• The "Non-retain" check box must be activated in the block properties of the DB, or</li> <li>• a non-retentive DB was generated with SFC 82 "CREA_DBL" and the associated block attribute (ATTRIB -&gt; NON_RETAIN bit).</li> </ul>	Requirement in <i>STEP 7</i> : <ul style="list-style-type: none"> <li>• The "Non-retain" check box must be deactivated in the block properties of the DB, or</li> <li>• A retentive DB was generated with SFC 82.</li> </ul>



### 5.1.4 Address areas of system memory

The system memory of the IM 151-8 PN/DP CPU interface module is broken down into operand areas (refer to the table below). In a corresponding operation of your user program, you address data directly in the relevant address area.

#### Address areas of system memory

Table 5- 3 Address areas of system memory

Address areas	Description
Process image of inputs	At every start of an OB 1 cycle, the IM 151-8 PN/DP CPU interface module reads the inputs from the input modules and saves the values to the process image input.
Process image of outputs	During its cycle, the program calculates the values for the outputs and writes these to the process image of outputs. At the end of the OB 1 cycle, the IM 151-8 PN/DP CPU interface module writes the calculated output values to the output modules.
Bit memory	This area provides memory for saving the intermediate results of a program calculation.
Timers	Timers are available in this area.
Counters	Counters are available in this area.
Local data	Temporary data in a code block (OB, FB, FC) is saved to this memory area while the block is being edited.
Data blocks	See <i>Recipes</i> and <i>Measured value logs</i>

#### Reference

The address areas of your IM 151-8 PN/DP CPU interface module are listed in the *S7-300 Instruction List*.

#### I/O process image

When the user program addresses the input (I) and output (Q) operand areas, it does not query the signal states of digital electronic modules. Instead, it accesses a memory area in the IM 151-8 PN/DP CPU interface module system memory. This particular memory area is the process image.

The process image is organized in two sections: The process image of inputs, and the process image of outputs.

##### Advantages of the process image

In contrast to direct access of the input / output modules, accessing the process image has the advantage that a consistent image of the process signals is made available to the IM 151-8 PN/DP CPU interface module during cyclic program execution. When the signal status at an input module changes during program execution, the signal status in the process image is maintained until the image is updated in the next cycle. Moreover, since the process image is stored in the IM 151-8 PN/DP CPU interface module system memory, access is significantly faster than direct access to the electronic modules.

### Process image update

The operating system updates the process image periodically. The figure below shows the sequence of this operation within a cycle.

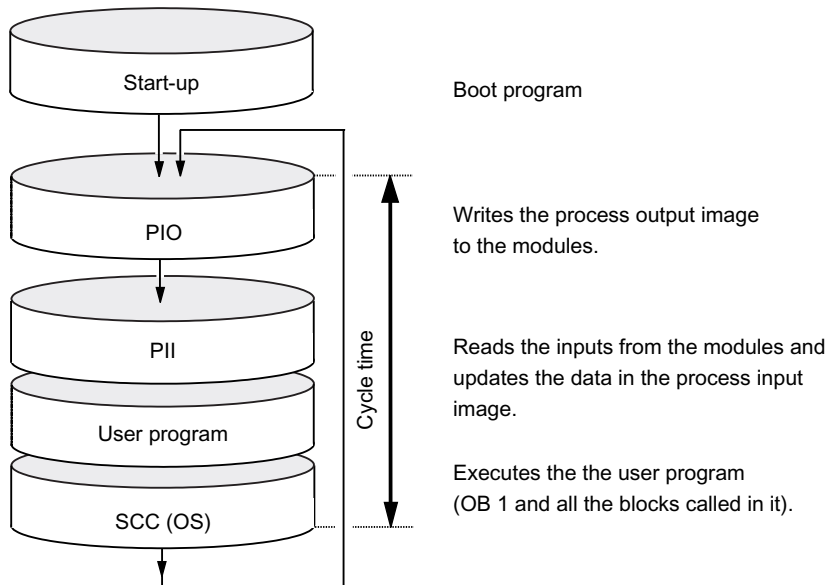

### Variable process image

In *STEP 7*, you can set the size of the I/O process image to any value from 0 to 2048 bytes for the IM151-8 PN/DP CPU.

Please observe the following::

#### Note

Currently, the dynamic setting of the process image only affects its update at the scan cycle control point. That is, the process input image is only updated up to the set PII size with the corresponding values of the peripheral input modules existing within this address area, or the values of the process output image up to the set POI size are written to the peripheral output modules existing within this address area.

This set size of the process image is ignored with respect to the *STEP 7* commands used to access the process image (for example U I100.0, L IW200, = Q20.0, T AD150, or the corresponding indirect addressing commands). However, up to the maximum size of the process image (that is, up to I/O byte 2047), these commands do not return any synchronous access errors, but rather access the permanently available internal memory area of the process image.

The same applies to the use of actual parameters of block calls from the I/O area (area of the process image).

Particularly if these process image limits were changed, you should check to which extent your user program continues to access the process image in the area between the set and the maximum process image size. If such access is to continue to take place, this means that inputs on the I/O module that change may not be detected or that outputs may not really be written to the output module without an error message being generated.

## Local data

Local data store:

- The temporary variables of code blocks
- The start information of the OBs
- Transfer parameters
- Intermediate results

### Temporary Variables

When you create blocks, you can declare temporary variables (TEMP) which are only available during block execution and then overwritten again. These local data have fixed length in each OB. Local data must be initialized prior to the first read access. Each OB also requires 20 bytes of local data for its start information.

The IM 151-8 PN/DP CPU interface module has memory for storing temporary variables (local data) of recently executed blocks. This memory is divided among the priority classes into partitions of equal size. Each priority class has its own local data area.

 <b>CAUTION</b>
--------------------------------------------------------------------------------------------------

<p>All temporary variables (TEMP) of an OB and its nested blocks are stored in local data. When using complex nesting levels for block processing, you may cause an overflow in the local data area.</p> <p>The IM 151-8 PN/DP CPU interface module will change to STOP mode if the permissible length of the local data for a priority class is exceeded.</p> <p>Make allowances for local data space required for synchronous error OBs. This is assigned to the respective triggering priority class.</p>
--------------------------------------------------------------------------------------------------------------------------------------------------------------------------------------------------------------------------------------------------------------------------------------------------------------------------------------------------------------------------------------------------------------------------------------------------------------------------------------------------------------

## See also

Retentivity of load memory, system memory and RAM (Page 110)

### 5.1.5 Properties of the SIMATIC Micro Memory Card

#### The SIMATIC Micro Memory Card as a memory module for the IM 151-8 PN/DP CPU interface module

The memory module used in your IM 151-8 PN/DP CPU interface module is a SIMATIC Micro Memory Card. It can be used as load memory or as a portable storage medium.

---

**Note**

The IM 151-8 PN/DP CPU interface module requires the SIMATIC Micro Memory Card for operation.

---

The following data are stored on the SIMATIC Micro Memory Card.

- User programs (all blocks)
- Archives and recipes
- Configuration data (*STEP 7* projects)
- Data for operating system update and backup

---

**Note**

You can either store user and configuration data or the operating system on the SIMATIC Micro Memory Card.

---

#### Properties of a SIMATIC Micro Memory Card

The SIMATIC Micro Memory Card ensures maintenance-free and retentive operation of the IM 151-8 PN/DP CPU interface module .

#### SIMATIC Micro Memory Card copy protection

Your SIMATIC Micro Memory Card has an internal serial number that implements an MMC copy protection. You can read this serial number from the SSL partial list 011C<sub>H</sub> index 8 using SFC 51 "RDSYSST." If the reference and actual serial number of your SIMATIC Micro Memory Card are not the same, program a STOP command in a know-how-protected module, for example.

#### Reference

Additional information

- on the *SSL partial list* refer to the *S7-300 Instruction list* or the *System and standard functions for S7-300/400* Reference Manual.
- to memory reset the IM 151-8 PN/DP CPU interface module, refer to section *Resetting the IM 151-8 PN/DP CPU interface module using the mode selector switch*.

### Useful life of a SIMATIC Micro Memory Card

The life of an SIMATIC Micro Memory Card depends mainly on the following factors:

1. The number of delete or programming cycles
2. External influences such as ambient temperature

At ambient temperatures up to 60 °C, up to 100,000 delete/write operations can be performed on a SIMATIC Micro Memory Card.



To prevent data losses, do not exceed this maximum of delete/write operations.

### See also

Retentivity of load memory, system memory and RAM (Page 110)

Operating and display elements of the IM 151-8 PN/DP CPU interface module (Page 23)

## 5.2 Memory functions

### 5.2.1 General: Memory functions

#### Memory functions

Memory functions are used to generate, modify or delete entire user programs or specific blocks. You can also ensure that your project data are retained by archiving these. If you created a new user program, use a programming device/PC to download the complete program to the SIMATIC Micro Memory Card.

## 5.2.2 Downloading user programs via SIMATIC Micro Memory Card to the IM 151-8 PN/DP CPU interface module

### User program download

The entire user program is downloaded from your PD / PC to the IM 151-8 PN/DP CPU interface module via the SIMATIC Micro Memory Card. The previous content of the SIMATIC Micro Memory Card is deleted in the process. Blocks use the load memory area as specified under "Load memory requirements" in "General block properties".

The figure shows the load and work memory of the IM 151-8 PN/DP CPU interface module .

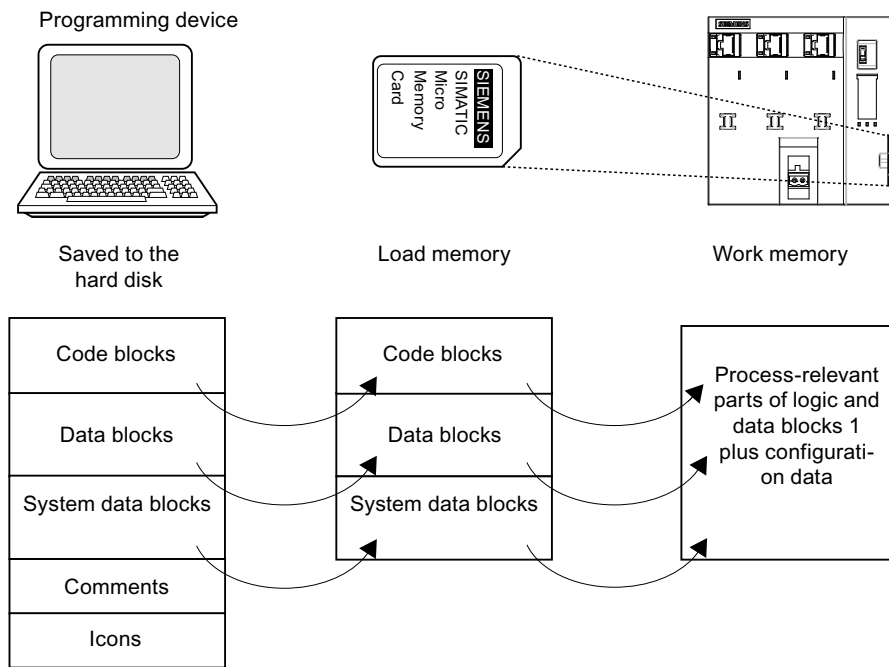

<sup>1</sup>: If not all of the work memory area is retentive, the retentive part is indicated in the *STEP 7* module status as retentive memory. You cannot run the program until all the blocks are downloaded.

### Note

This function is only permissible if the IM 151-8 PN/DP CPU interface module is in STOP mode. Load memory is cleared if the load operation could not be completed due to power loss or illegal block data.

## 5.2.3 Handling blocks

### 5.2.3.1 Encryption of blocks

#### Important information

---

**Note****Supported blocks**

S7 Block Privacy can be used to encrypt only function blocks (FBs) and functions (FCs).

---

Once blocks have been encrypted in STEP 7 they can no longer be edited or monitored. Nor can any test or commissioning functions, such as status blocks or breakpoints, be performed.

#### Requirement

The "S7 Block Privacy" extension package supplied with STEP 7 must be installed. Only by this means can blocks be hard encrypted.

#### General procedure

In order to encrypt the blocks, proceed as follows:

1. In the HW config, select the desired block (multiple selection can be made).
2. Right click on the block to be encrypted, and select "Encrypt block...". The "Block encryption" dialog box opens.
3. Select whether decompilation information should also be encrypted.

---

**Note**

If you deactivate the check box, there is no way the block can be decompiled.

---

4. Enter a code of at least 12 characters in both fields. Make sure the code is securely stored. Press the "OK" button to start the encryption.

Result: Your block is now encrypted. This is indicated by the following symbols:



Block that can be decompiled



Block that cannot be decompiled

---

**Note**

**Run time for the command**

Typically the run time for the command is extended because the encrypted blocks could not be executed in a fully optimized manner. The resulting cycle time can be determined only with encrypted blocks

---

**Note**

**Extended run times for POWER ON/memory reset/download**

The ramp-up time for the CPU, the time required for memory reset and the loading time of blocks can be extended significantly.

---

**Additional information**

For further information please refer to the STEP 7 online Help under "S7 Block Privacy".

**5.2.3.2 Download of new blocks or delta downloads**

There are two ways to download additional user blocks or download deltas:

- Download of blocks: You have already created a user program and downloaded it to the IM 151-8 PN/DP CPU interface module via the SIMATIC Micro Memory Card. You then want to add new blocks to the user program. In this case you do not need to reload the entire user program to the MCC. Instead you only need to download the new blocks to the SIMATIC Micro Memory Card (this reduces the download times for highly complex programs.)
- Delta download: In this case, you only download the deltas in the blocks of your user program. In the next step, perform a delta download of the user program, or only of the changed blocks to the SIMATIC Micro Memory Card, using the programming device/PC.

 <b>WARNING</b>
The delta down of block / user programs overwrites all data stored under the same name on the SIMATIC Micro Memory Card.

The data of dynamic blocks are transferred to RAM and activated after the block is downloaded.

**5.2.3.3 Uploading blocks**

In contrast to downloading, uploading involves the transfer of individual blocks or a complete user program from the IM 151-8 PN/DP CPU interface module to the programming device / PC. In doing so, the blocks have the content of the last download in the IM 151-8 PN/DP CPU interface module. Dynamic DBs form the exception, because their actual values are transferred. Uploading blocks or the user program from the IM 151-8 PN/DP CPU interface module in *STEP 7* does not affect the memory assignment of the IM 151-8 PN/DP CPU interface module.



#### 5.2.3.4 Deleting blocks

When you delete a block, it is deleted from load memory. In *STEP 7*, you can also delete blocks with the user program (DBs also with SFC 23 "DEL\_DB"). RAM used by this block is released.

#### 5.2.3.5 Compressing blocks

When data are compressed, gaps which have developed between memory objects in load memory/RAM as a result of load/delete operations will be eliminated. This releases free memory in a continuous block. You can compress both in STOP mode as well as in RUN mode of the IM 151-8 PN/DP CPU interface module.

#### 5.2.3.6 Promming (RAM to ROM)

When writing the RAM content to ROM, the actual values of the DBs are transferred from RAM to load memory to form the start values for the DBs.

---

**Note**

This function is only permissible if the IM 151-8 PN/DP CPU interface module is in STOP mode. Load memory is cleared if the function could not be completed due to power loss.

---

### 5.2.4 CPU memory reset and restart

#### Memory reset

After inserting or removing a SIMATIC Micro Memory Card, a complete memory reset restores the IM 151-8 PN/DP CPU interface module to defined conditions in order to make a restart (warm start) possible. When resetting the IM 151-8 PN/DP CPU interface module, the memory management of the IM 151-8 PN/DP CPU interface module is reestablished. Blocks in load memory are retained. All dynamic runtime blocks are transferred once again from load memory to RAM, in particular to initialize the data blocks in RAM (restore initial values).

#### Restart (warm start)

- All retentive DBs retain their current values. Non-retentive DBs are reset to their initial values.
- The values of all retentive M, C, T are retained.
- All non-retentive user data are initialized:
  - M, C, T, I, O with "0"
- All run levels are initialized.
- The process images are deleted.

### Reference

Read also section *Resetting the IM 151-8 PN/DP CPU interface module using the mode selector switch*.

### See also

Reset the IM 151-8 PN/DP CPU interface module using the mode selector switch (Page 151)

## 5.2.5 Recipes

### Introduction

A recipe represents a collection of user data. You can implement a simple recipe concept using static DBs. In this case, the recipes should have the same structure (length). One DB should exist per recipe.

### Processing sequence

#### Recipe is written to load memory:

- The individual data records of the recipes are created as static DBs in *STEP 7* and then downloaded to the IM 151-8 PN/DP CPU interface module. Therefore, recipes only use load memory, rather than RAM.

#### Working with recipe data:

- SFC83 "READ\_DBL" is called in the user program to copy the data record of a current recipe from the DB in load memory to a static DB that is located in work memory. As a result, the RAM only has to accommodate the data of one record. The user program can now access data of the current recipe. The figure below shows how to handle recipe data:

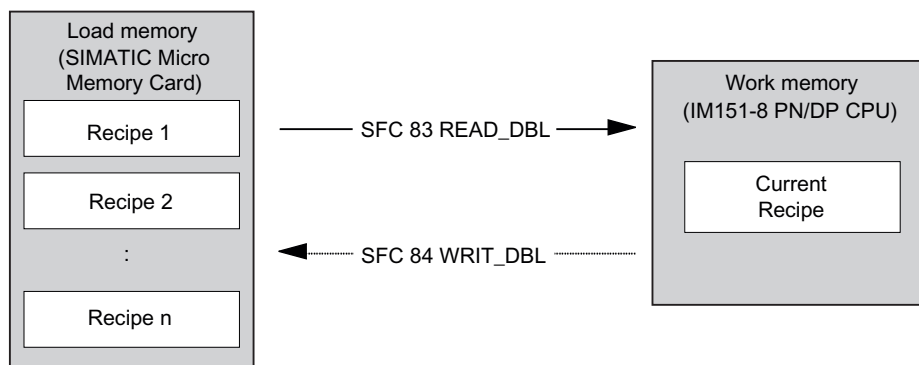

**Saving a modified recipe:**

- The data of new or modified recipe data records generated during program execution can be written to load memory. To do this, call SFC 84 "WRIT\_DBL" in the user program. The data written to load memory are portable and retentive on Memory reset. You can backup modified records (recipes) by uploading and saving these in a single block to the programming device/PC.

---

**Note**

Active system functions SFC82 to 84 (active access to the SIMATIC Micro Memory Card) have a distinct influence on programming device functions (for example, block status, variable status, download block, upload, open.) This typically reduces performance (compared to passive system functions) by a factor of 10.

---

**Note**

To prevent data losses, do not exceed this maximum of delete/write operations.

---

 **CAUTION**

Data on a SIMATIC Micro Memory Card can be corrupted if you remove the card while it is being accessed by a write operation. In this case, you may have to delete the SIMATIC Micro Memory Card on your PD, or format the card in the IM151-8 PN/DP CPU interface module.

Never remove a SIMATIC Micro Memory Card in RUN mode. Always remove it when power is off, or when the IM151-8 PN/DP CPU interface module is in STOP state, and when the PD is not writing to the card. If the CPU is in STOP mode and you cannot not determine whether or not a PD is writing to the card (e.g. load/delete block), disconnect the communication lines.

## 5.2.6 Measured value log files

### Introduction

Measured values are generated when the IM 151-8 PN/DP CPU interface module executes the user program. These measured values are to be logged and analyzed.

### Processing sequence

#### Acquisition of measured values:

- The IM 151-8 PN/DP CPU interface module writes all measured values to a DB (for alternating backup mode in several DBs) which is located in the work memory.

#### Measured value logging:

- Before the data volume can exceed work memory capacity, you should call SFC 84 "WRIT\_DBL" in the user program to swap measured values from the DB to load memory. The figure below shows how to handle measured value log files:

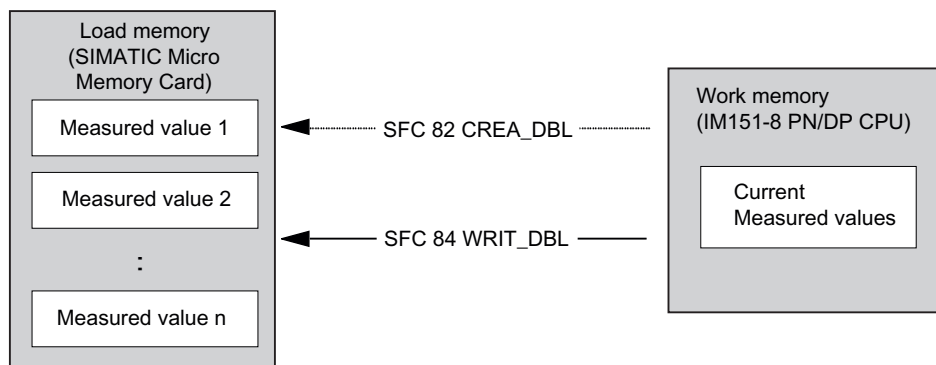

- You can call SFC 82 "CREA\_DBL" in the user program to generate new (additional) static DBs in load memory which do not require RAM space.

## Reference

For additional information on the block SFC 82 can be found in the *System and Standard Functions for S7-300/400* reference manual, or in the *STEP 7 Online Help*.

---

### Note

SFC 82 is terminated and an error message is generated if a DB already exists under the same number in load memory and/or work memory.

---

The data written to load memory are portable and retentive on Memory reset.

### Evaluation of measured values:

- Measured value DBs saved to load memory can be uploaded and evaluated by other communication partners (programming device, PC, for example).
- 

### Note

Active system functions SFC82 to 84 (active access to the SIMATIC Micro Memory Card) have a distinct influence on PG functions (for example, block status, variable status, download block, upload, open.) This typically reduces performance (compared to passive system functions) by a factor of 10.

---

### Note

With the IM 151-8 PN/DP CPU interface module you can also generate non-retentive DBs using SFC 82 (parameter ATTRIB -> NON\_RETAIN bit.)

---

### Note

To prevent data losses, do not exceed this maximum of delete/write operations.

---

## 5.2.7 Backup of project data to SIMATIC Micro Memory Card

### Function principle

Using the **Save project to Memory Card** and **Fetch project from Memory Card** functions, you can save all project data to a SIMATIC Micro Memory Card, and retrieve these at a later time. For this operation, the SIMATIC Micro Memory Card can be located in the IM 151-8 PN/DP CPU interface module or in the programming adapter of a programming device or PC.

Project data is compressed before it is saved to a SIMATIC Micro Memory Card, and uncompressed on retrieval.

---

#### Note

In addition to project data, you may also have to store your user data on the MMC. You should therefore first select a SIMATIC Micro Memory Card with sufficient free memory.

A message warns you if the memory capacity on your SIMATIC Micro Memory Card is insufficient

---

The volume of project data to be saved corresponds with the size of the project's archive file.

---

#### Note

For technical reasons, you can only transfer the entire contents (user program and project data) using the **Save project to memory card** action.

---

# Mounting and connecting

## 6.1 Content

### Where can I find what information?

You will find comprehensive information about fitting and connecting an ET 200S in the relevant sections of the *ET 200S Distributed I/O Device Operating Instructions*.

The following sections will show you the differences and special features associated with using an ET 200S with the IM 151-8 PN/DP CPU interface module.

## 6.2 Installing the IM 151-8 PN/DP CPU interface module

### Introduction

The IM 151-8 PN/DP CPU interface module connects the ET 200S with PROFINET.

### Requirement

The mounting rail is installed.

### Procedure

1. Mount the IM 151-8 PN/DP CPU interface module.
2. Mount the required terminal modules.

---

#### Note

##### Note the installation sequence

If you wish to extend the IM 151-8 PN/DP CPU interface module with an optional DP master module, you must first of all install the DP master module before you install the required terminal module.

---

3. Mount the terminating module.

### Reference

The mounting is described in the ET 200S Distributed I/O System (<http://support.automation.siemens.com/WW/view/en/1144348>) Operating Instructions.

## 6.3 Connecting the IM 151-8 PN/DP CPU interface module

### Introduction

You connect the supply voltage and PROFINET IO to the IM 151-8 PN/DP CPU interface module. The IM 151-8 PN/DP CPU interface module is equipped with an internal PROFINET switch. This allows the PROFINET to be looped through directly, or an additional IO device (e.g. ET 200S with IM 151-3 PN) to be connected directly.

The structure of a ring topology with media redundancy is performed using the ring ports P1 R and P2 R. Further IO devices can be connected at port P3; these will however lie outside the redundancy domain.

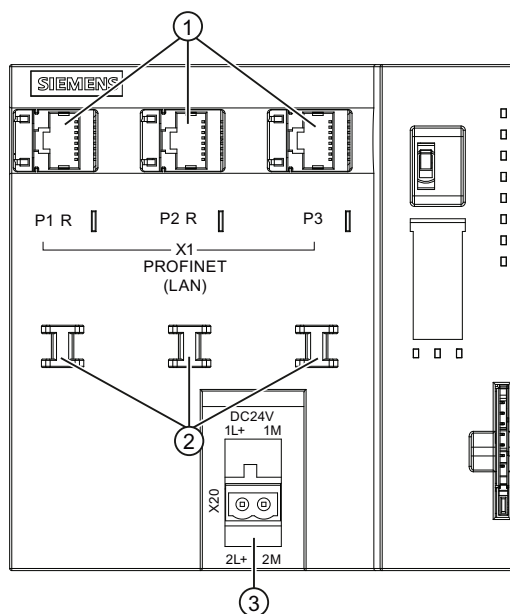

- ① Connection for PROFINET IO (RJ45 sockets, 3 ports)  
P1 R, P2 R: Ring port for creation of ring topology with media redundancy
- ② Cable holder
- ③ Connection for supply voltage

<p><b>⚠ CAUTION</b></p> <p><b>PROFINET</b></p> <p>Modules with PROFINET interfaces may only be operated in LANs (Local Area Network) in which all nodes are equipped with SELV / PELV power supplies or protection systems of equal quality.</p> <p>A data transfer terminal (modem, for example) is required to access the WAN (Wide Area Network) in order to ensure compliance with this safety standard.</p>
------------------------------------------------------------------------------------------------------------------------------------------------------------------------------------------------------------------------------------------------------------------------------------------------------------------------------------------------------------------------------------------------------------------



## Requirements

- The IM 151-8 PN/DP CPU interface module is installed on the mounting rail.
- Wire the interface module with the supply voltage switched off.

## Required tools

Industrial Ethernet Fast Connect stripping tool (6GK1901-1GA00)  
(stripping tool for Industrial Ethernet Fast Connect installation cables)

## Power supply

You may only use SELV / PELV-type power supply units with a guaranteed electrically isolated extra-low voltage ( $\leq 60$  V DC).

## Required accessories

- Cable with maximum 2.5 mm<sup>2</sup> conductor cross section for the supply voltage
- PROFINET connector (according to the specifications in the *PROFINET Installation Guide*)

The following are suitable:

PROFINET RJ45 connector with Fast Connect connection system, 90° cable outlet	6GK1901-1BB20-2AA0
-------------------------------------------------------------------------------------	--------------------

- Industrial Ethernet Fast Connect installation cables

The following are suitable:

Fast Connect standard cable	6XV1840-2AH10
Fast Connect trailing cable	6XV1840-3AH10
Fast Connect marine cable	6XV1840-4AH10

### Installing the PROFINET cable connector

Install the PROFINET cable connector according to the information in the *PROFINET Installation Guide*.

The *PROFINET Cabling and Interconnection Technology, Version 1.99* guideline can be found at "PROFINET (<http://www.profinet.com>)" in the *Downloads* area.

#### Pin assignment for the RJ45 cable connector

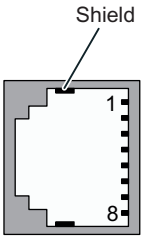
View of the RJ45 socket	Terminal	Assignment
 A diagram of an RJ45 socket. It shows a rectangular socket with a shield on the left side. The shield is labeled "Shield" with a line pointing to it. The socket has eight terminals on the right side, numbered 1 through 8. Terminal 1 is at the top, and terminal 8 is at the bottom.	1	RD (Receive Data +)
	2	RD_N (Receive Data -)
	3	TD (Transmit Data +)
	4	Ground
	5	Ground
	6	TD_N (Transmit Data -)
	7	Ground
	8	Ground

### Connecting PROFINET IO

Connect the PROFINET IO as follows:

1. Insert the PROFINET cable connector onto the PROFINET terminal X1 P1.
2. Clamp the PROFINET cable securely in the cable holder.

The integrated switch enables looping through of PROFINET IO.

If necessary, you can connect the PROFINET connections X1 P2 and X1 P3 to other I/O devices.

### Connecting the supply voltages

The voltage supply is over a connecting plug. When it ships, this is connected to the connection for the supply voltage on the 151-8 PN/DP CPU interface module. The connecting plug makes it possible to loop the voltage supply uninterrupted.

Pin assignment of the interface:

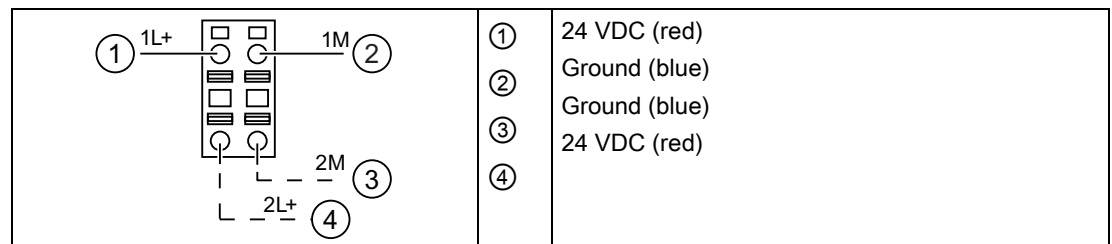

Connect the supply voltage as follows:

1. Strip the wires for the supply voltage to 10 mm.
2. Insert the individual cables into the spring-loaded terminal (round openings) of the cable connector.
3. Insert the wired connector onto the 24 VDC terminal of the 151-8 PN/DP CPU interface module.
4. Please ensure that there is sufficient strain relief.

## 6.4 Installing and connecting the DP master module

If you wish to extend the IM 151-8 PN/DP CPU interface module with an optional DP master module, you can use the 151-8 PN/DP CPU interface module as a DP master. Connect the PROFIBUS DP to the DP master module.

### Requirements

- The mounting rail has been fitted (see the ET 200S Distributed I/O Device (<http://support.automation.siemens.com/WW/view/en/1144348>) Operating Instructions).
- The 151-8 PN/DP CPU interface module is installed on the mounting rail (see Installing the 151-8 PN/DP CPU interface module (Page 127)).

#### Note

You should install the required terminal module only having first installed the DP master module.

**Installing the DP master module**

1. Suspend the DP master module in the mounting rail to the right of the IM151-8 PN/DP CPU interface module.
2. Rotate the DP master module to the back until it engages.
3. Slide the DP master module to the left until it audibly engages with the IM151-8 PN/DP CPU interface module.

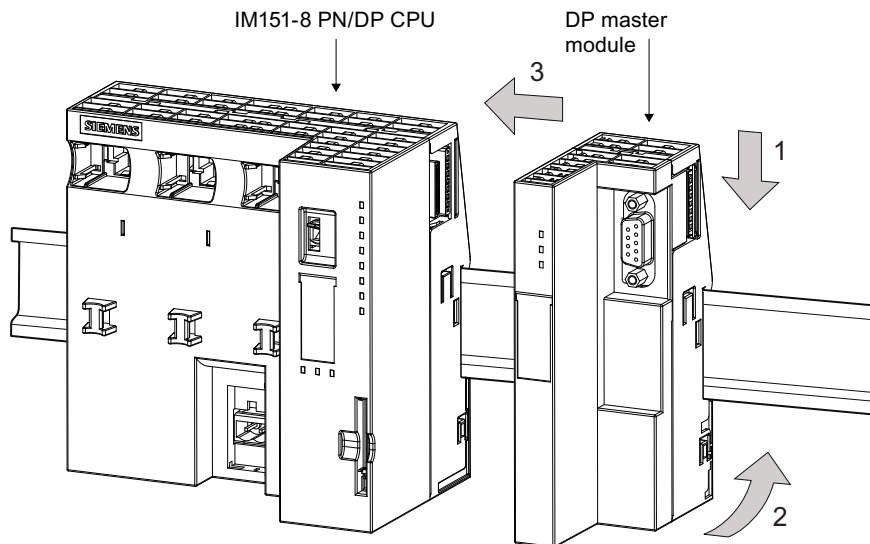

Figure 6-1 Installing the DP master module

**Connecting PROFIBUS DP**

Connect the PROFIBUS DP as follows:

- Use a pre-fabricated PROFIBUS cable.
- Insert the bus connector in the X1 connection socket on the DP master module.
- Screw the bus connector into the connection socket.

**Pin assignment for the bus connector:**

View of the connection socket	Terminal	Signal	Designation
<p>RS 485 interface</p>	1	–	–
	2	–	–
	3	RxD / TxD-P	Data line B
	4	RTS	Request To Send
	5	M5V2	Data reference potential (station)
	6	P5V2	Supply plus (station)
	7	–	–
	8	RxD / TxD-N	Data line A
	9	–	–

## Addressing

### 7.1 Addressing the I/O modules

#### 7.1.1 Slot-oriented addressing of the centralized I/O modules

##### Slot-oriented addressing

A slot-oriented addressing is available only for the centralized I/O of the IM 151-8 PN/DP CPU interface module. If the IM 151-8 PN/DP CPU interface module is started up without a configuration loaded, then the I/O modules are addressed by slot by default.

This is the digital or analog address set by default according to the type of I/O module (see table below).

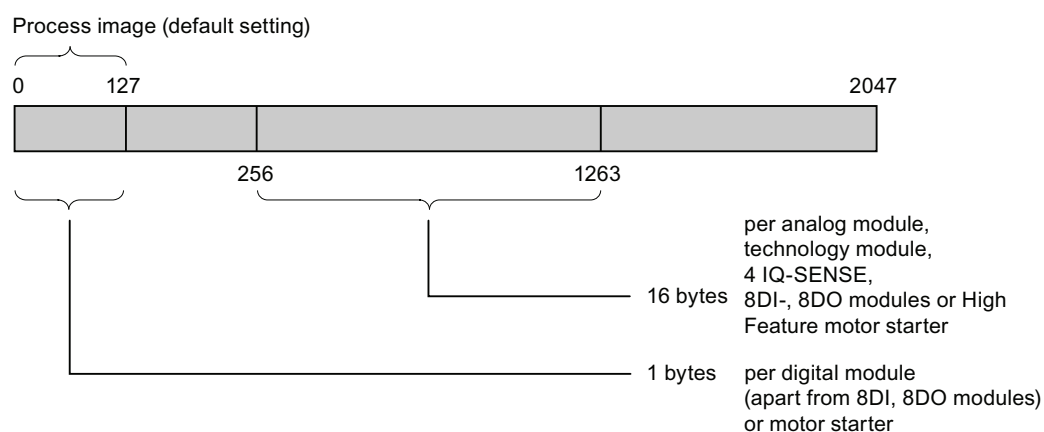

Figure 7-1 Structure of the default address area

**Slot assignment**

The figure below shows an ET 200S configuration with digital and analog electronic modules as well as the technology modules and slot assignment.

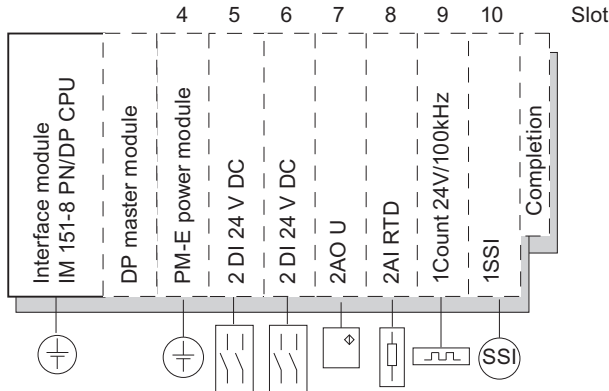

Figure 7-2 Slots for the ET 200S

**Address assignment**

Depending on the slot, 1 byte is reserved in the address areas of the IM151-8 PN/DP CPU interface module for digital I/Os and motor starters, and 16 bytes is reserved for analog I/Os, technology modules, 4 IQ-SENSE and High Feature motor starters (up to 63 I/O modules).

The table below indicates the default address assignment for analog and digital modules per slot for slot-oriented addressing.

Table 7- 1 Default address assignment for centralized I/O modules in an ET 200S with IM 151-8 PN/DP CPU interface module

Reserved Address Area	Slot number									
	1	2	3	4	5	6	7	8	...	66
Digital modules (apart from 8DI, 8DO modules) motor starters	IM 151-8 PN/DP CPU <sup>1</sup>			-	1	2	3	4	...	62
Analog modules, technology modules, 4 IQ SENSE, 8DI, 8DO modules, High Feature motor starters				-	272 to 287	288 to 303	304 to 319	320 to 335	...	1248 to 1263
Power modules <sup>2</sup>				256	272	288	304	320	...	1248

<sup>1</sup> with X1 P1 / P2 / P3 as PROFINET interface and X1 as DP interface  
<sup>2</sup> Diagnostics addresses (no user data)

**Note**

The following digital modules are treated as analog or TF modules for default address assignment purposes:

- 6ES7131-4BF00-0AA0
- 6ES7131-4BF50-0AA0
- 6ES7132-4BF00-0AA0
- 6ES7132-4BF00-0AB0
- 6ES7132-4BF50-0AA0
- 6ES7131-4RD00-0AB0
- 6ES7131-4RD02-0AB0

**Example of Slot-Oriented Address Assignment for I/O Modules**

The figure below illustrates a sample ET 200S configuration, showing an example of the address allocation for I/O modules. The addresses for the I/O modules are predefined in default addressing.

Slot numbers	1 ... 3	4	5	6	7	8
ET 200S	IM151-8 PN/DP CPU	PM	4 DI	2 AI	2 AO	4 DO
assigned addresses		256 *	1.0 ... 1.3	288 ... 291	304 ... 307	4.0 ... 4.3

\* Diagnostics address

Figure 7-3 Example of address assignment for I/O modules

### 7.1.2 User-oriented addressing of the I/O Modules

#### User-oriented addressing

User-oriented module addressing is possible with both centralized and distributed I/Os.

User-oriented addressing means you can freely select

- Input addresses for modules and
- Output addresses for modules

within the range 0 to 2047 with byte-level granularity independently of one another. Assign the addresses in *STEP 7*. Specify the module start address that forms the basis for all other addresses of the module.

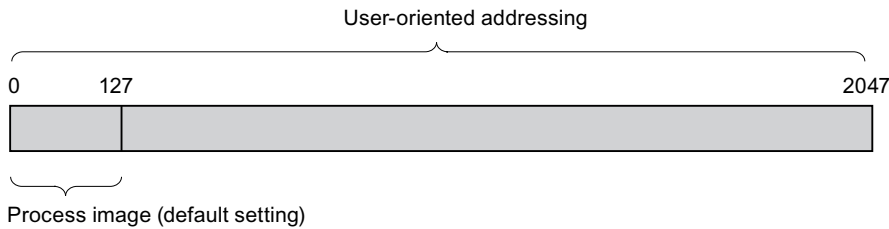

Figure 7-4 Structure of the address area for user-oriented addressing

---

#### Note

If you are using PROFIBUS DP or PROFINET IO field devices, then you must always configure the hardware in *STEP 7* HW Config. User-oriented addressing of modules is used automatically, and there is no fixed slot addressing.

---

#### Advantage

Advantages of user-oriented addressing:

- You can make the best possible use of the available address spaces because there are no "address gaps" between the modules.
- When creating standard software, you can specify addresses that are independent of the configuration of the ET 200S station.



## 7.2 Addressing on PROFIBUS DP

### Overview

The relevant DP slaves must first be brought into service on the PROFIBUS DP before the distributed I/Os can be addressed from the user program.

During this commissioning process:

- PROFIBUS addresses are assigned to the slaves
- Address ranges are assigned to the input / output modules or slots so that they can be addressed from the user program. Slots without user data are given a diagnostics address.

Additional information on commissioning the IM 151-8 PN/DP CPU interface module as a DP master module can be found in the *Commissioning PROFIBUS DP* section.

### User-oriented addressing of the distributed PROFIBUS I/Os

You must use user-oriented addressing for the distributed PROFIBUS DP I/Os.

Information can be found in the *User-oriented addressing of the I/O modules* section.

### Addressing consistent user data areas

The table below illustrates the points to consider with respect to communication in a PROFIBUS DP master system if you want to transfer I/O areas with "Total length" consistency.

<b>For 1 to 32 byte data consistency on the PROFIBUS DP:</b>
The address area of consistent data in the process image is automatically updated.
To read and write consistent data, you can also use SFC 14 "DPRD_DAT" and SFC 15 "DPWR_DAT". If the address area of consistent data is not in the process image, you must use SFC 14 and SFC 15 to read and write consistent data.
The length in the SFC must tally with the length of the programmed area when accessing areas with "Total length" consistency.
Direct access to consistent areas is also possible (e.g. L PEW or T PAW).
In a PROFIBUS DP system you can transfer up to 32 bytes of consistent data.

### See also

Commissioning the IM 151-8 PN/DP CPU interface module with DP master module as a DP master (Page 166)

User-oriented addressing of the I/O Modules (Page 136)

## 7.3 Addressing PROFINET IO

### 7.3.1 Addressing on PROFINET IO

#### Overview

The relevant IO devices must first be brought into service on the PROFINET IO before the distributed I/Os can be addressed from the user program.

During this commissioning process:

- Address ranges are assigned to the input / output modules or slots / subslots so that they can be addressed from the user program. Slots without user data are given a diagnostics address.
- The device number and device name are defined for the IO devices.
- The device names are assigned to the IO devices so that the IM 151-8 PN/DP CPU interface module, as the IO controller, can assign an IP address to and thus address the IO devices.

---

#### Note

##### **Name assignment for I/O devices with "Device replacement without removable medium"**

If the functionality "Device replacement without removable medium" is configured in HW Config, IO devices can also be replaced without the user having to assign a name. To do so, the IO device must be reset to the factory setting.

---

#### Note

##### **IP address parameter / device name in relation to the other path (PN CPU)**

- IP address parameters / device names via DCP:  
IP address parameters / device names are assigned by DCP (Discovery and Configuration Protocol). This can be done in two ways:
    - by a set-up tool such as PST or STEP 7, e.g. via "Edit Ethernet Nodes"
    - by the higher-level controller, if the CPU is operated as an I device.
  - IP address parameters / device names via the user program:  
The assignment of IP address parameters and/or device names is performed in the user program of the CPU (via the SFB 104).
- 

#### Reference

- Other methods of assigning the IP addresses can be found in the section Assignment of the IP address parameters and the device name (Page 139).
- Additional information on commissioning the IM 151-8 PN/DP CPU interface module as an IO controller can be found in the Commissioning PROFINET IO (Page 173) section.

## User-oriented addressing of the distributed PROFINET I/Os

You must use user-oriented addressing for the distributed PROFINET IO I/Os.

Information can be found in the User-oriented addressing of the I/O modules (Page 136) section.

## Addressing consistent user data areas

The table below illustrates the points to consider with respect to communication in a PROFINET IO system if you want to transfer I/O areas with "Total length" consistency.

For 1 to 1024 byte data consistency on the PROFINET IO:
The address area of consistent data in the process image is automatically updated.
To read and write consistent data, you can also use SFC 14 "DPRD_DAT" and SFC 15 "DPWR_DAT". If the address area of consistent data is not in the process image, you must use SFC 14 and SFC 15 to read and write consistent data.
The length in the SFC must tally with the length of the programmed area when accessing areas with "Total length" consistency.
Direct access to consistent areas is also possible (e.g. L PEW or T PAW).
In a PROFINET IO system you can transfer up to 1024 bytes of consistent data.

## 7.3.2 Assignment of the IP address parameters and device name

### IP address parameters / device name

Just like any other PROFINET device, the CPU (or its PN interface) requires IP address parameters and a device name for communication via PROFINET.

The IP address parameters consist of three parts:

- IP address
- Subnet screen
- Address of the router

### Retentivity of IP address parameters and device names

The retentivity of IP address parameters and device names depends on how they were assigned. Non-retentive temporary assignment means:

- IP address parameters and device name remain valid only until the next POWER OFF or memory reset. After POWER OFF / POWER ON or memory reset, the CPU is only accessible by means of its MAC address.
- Loading a temporary IP address deletes even retentively stored IP address parameters.

### Assignment of IP address parameters and device names

The IP address parameters and the device name can be assigned in the following ways:

Assignment of IP address parameters and device names		Retentive memory
Standard method: Permanent assignment in STEP 7	IP address parameters / device name are permanently assigned during the configuration in <i>STEP 7</i> . When the configuration is loaded to the CPU, the IP address parameters / device name are also stored retentively in the CPU.	The data are retentive: <ul style="list-style-type: none"> <li>at POWER OFF / POWER ON</li> </ul>
Permanent assignment by setting "IP address parameters / device name in relation to the other path"	IP address parameters / device name are assigned by DCP (Discovery and Configuration Protocol): <ul style="list-style-type: none"> <li>By a set-up tool such as PST or in <i>STEP 7</i>, e.g. by "Edit Ethernet Nodes".</li> <li>By the higher-level IO controller, if the IM 151-8 PN/DP CPU is operated as an I device with prioritized start-up.</li> </ul>	<ul style="list-style-type: none"> <li>after memory reset</li> <li>after deletion of the configuration (SDBs)</li> <li>after removal of the MMC</li> </ul>
Temporary assignment in STEP 7	IP address parameter / device name are assigned by DCP (Discovery and Configuration Protocol): <ul style="list-style-type: none"> <li>By automatic IP address assignment via "Accessible Nodes" in <i>STEP 7</i>, if the CPU does not yet have an IP address.</li> </ul>	The data are <b>not</b> retentive.
Temporary assignment by setting "IP address parameters / device name in relation to the other path"	IP address parameter / device name are assigned by DCP (Discovery and Configuration Protocol): <ul style="list-style-type: none"> <li>When the IP address parameter device name is assigned to the I device by the higher-level IO controller, if the I device is <b>not</b> operated with prioritized start-up.</li> </ul>	
Assignment in the user program	IP address parameters / device name are assigned in the user program by means of SFB 104. The retentivity of the IP address parameters / device name can in this case be specified in the respective parameter data record.	Retentivity corresponding to the specifications in the parameter data record

## Resetting retentive IP address parameters and device names

Retentive IP address parameters and device names can be reset as follows:

- By "Reset to factory settings"
- By a firmware update

<b>NOTICE</b>
---------------

- |                                                                                                                                                                                                                                                                                                                                                                                                                        |
|------------------------------------------------------------------------------------------------------------------------------------------------------------------------------------------------------------------------------------------------------------------------------------------------------------------------------------------------------------------------------------------------------------------------|
| <ul style="list-style-type: none"><li>• If a temporary assignment of IP address parameters / device names is performed, any retentively saved IP address parameters / device names are reset.</li><li>• If a permanent assignment of IP address parameters / device names is performed, any retentively IP address parameters / device names previously saved are overwritten by the new parameter settings.</li></ul> |
|------------------------------------------------------------------------------------------------------------------------------------------------------------------------------------------------------------------------------------------------------------------------------------------------------------------------------------------------------------------------------------------------------------------------|

<b>NOTICE</b>
---------------

<b>Re-use of devices</b>
--------------------------

Perform "Reset to factory settings" before you install a device with retentive IP address parameters / device names in another subnet / system, or before you place it into storage.
--------------------------------------------------------------------------------------------------------------------------------------------------------------------------------------

## Reference

Further information on assignment of IP addresses on the I device can be found in the *online Help* for STEP 7.



## 8.1 Overview

This section contains important notes on commissioning which you should strictly observe in order to avoid injury or damage to machines.

---

### Note

Your commissioning phase is determined primarily by your application, so we can only offer you general information, without claiming completeness of this topic.

---

### Reference

Note the information about commissioning provided in the descriptions of your system components and devices.

## 8.2 Commissioning procedure

### 8.2.1 Procedure: Commissioning the hardware

#### Hardware requirements

- ET 200S is installed
- ET 200S is connected

With a networked ET 200S, the following applies to the interfaces

- PROFINET
  - the integrated PROFINET interface of the IM 151-8 PN/DP CPU interface module has been configured in *STEP 7* (IP address and device name set, for instance, in HW config)
  - the IM 151-8 PN/DP CPU interface module is connected to the subnet
- PROFIBUS (on optional DP master module)
  - the PROFIBUS address is set
  - the terminating resistors on the segments are enabled

**Recommended procedure: Hardware**

Due to its modular structure and the many different expansion options, an ET 200S can be very large and complex. It is therefore not a good idea to switch it on for the first time with all the modules installed. Rather, we recommend a step-by-step commissioning procedure.

We recommend the following initial commissioning procedure for an ET 200S:

Table 8- 1 Recommended commissioning procedure: Hardware

Activity	Remarks	Information on this can be found in section
An installation and wiring check according to checklist	-	<i>Commissioning check list</i>
Disconnecting drive aggregates and control elements	This prevents negative effects on your system as a result of program errors.  Tip: By redirecting data from your outputs to a data block, you can always check the status at the outputs	-
Preparing the IM 151-8 PN/DP CPU	Connect a programming device	<i>Connecting the programming device (PG)</i>
Start up the power supply and ET 200S with the IM 151-8 PN/DP CPU interface module and check the LEDs	Commission the power supply and the ET 200S with IM 151-8 PN/DP CPU interface module.	<i>Initial power on</i>
	Check the LED displays of the IM 151-8 PN/DP CPU interface module.	<i>Debugging functions, diagnostics and troubleshooting</i>
Reset the IM 151-8 PN/DP CPU interface module memory and check the LEDs	-	<i>Reset the IM 151-8 PN/DP CPU interface module using the mode selector switch</i>
Commission the rest of the modules	Plug the modules in according to the configuration and commission them.	<i>ET 200S Operating Instructions</i>

 <b>DANGER</b>
<p>Proceed step-by-step. Do not go to the next step unless you have completed the previous one without error / error message.</p>

**Reference**

Important notes can also be found in the *Debugging Functions, Diagnostics and Troubleshooting* section.

**See also**

Procedure: Software commissioning (Page 145)



## 8.2.2 Procedure: Software commissioning

### Requirements

- You have installed and connected your ET 200S with IM 151-8 PN/DP CPU.
- In order to utilize the full functionality of your IM 151-8 PN/DP CPU interface module, you require *STEP 7*V5.5.
- If the ET 200S is being networked with PROFINET,
  - the integrated PROFINET interface of the IM 151-8 PN/DP CPU interface module has been configured in *STEP 7* (IP address and device name set in HW Config)
  - the IM 151-8 PN/DP CPU interface module is connected to the subnet.
- If the ET 200S is being networked with PROFIBUS (at the optional DP master module),
  - the PROFIBUS address is set
  - The terminating resistors on the segment limits are enabled.

---

#### Note

Please observe the procedure for commissioning the hardware.

---

### Recommended procedure: Software

Table 8- 2 Recommended commissioning procedure: Software

Activity	Remarks	Information can be found ...
<ul style="list-style-type: none"> <li>• Switch on the programming device and run SIMATIC Manager</li> <li>• Transferring the configuration and program to the IM 151-8 PN/DP CPU interface module:  The IM 151-8 PN/DP CPU interface module logs on to the SIMATIC Manager with its MAC address via "Available nodes". If the Ethernet interface of the PD is set to <b>TCP/IP (Auto)</b>, then during the first establishment of a communication connection (e.g. double-clicking this network node that displays only the MAC address in order to open the online block container), a temporary IP address is automatically assigned by the PD to the PN interface of the IM 151-8 PN/DP CPU interface module. Now the blocks, especially also the SDB container with the HW configuration, can be moved by drag-and-drop from the offline block container to the online block container. When loading the SDB container, the IP address assigned by <i>STEP 7</i> in the HW Config are also transferred by the IM 151-8 PN/DP CPU interface module.</li> </ul>	-	in the <i>Programming with STEP 7</i> Manual

Activity	Remarks	Information can be found ...
Debugging the I/Os	Helpful functions are here: <ul style="list-style-type: none"> <li>• Monitoring and modifying variables</li> <li>• Testing with program status</li> <li>• Forcing</li> <li>• Controlling the outputs in STOP mode (PO enable)</li> </ul> <b>Tip:</b> Test the signals at the inputs and outputs	<ul style="list-style-type: none"> <li>• in the <i>Programming with STEP 7 Manual</i></li> <li>• in the <i>Alarm, error and system messages</i> section</li> </ul>
Commissioning PROFINET IO		<ul style="list-style-type: none"> <li>• in the <i>Commissioning PROFINET IO</i> section</li> <li>• in the <i>System Description PROFINET</i></li> </ul>
Commissioning PROFIBUS DP	-	in the <i>Commissioning PROFIBUS DP</i> section
Connect the outputs	Commissioning the outputs successively.	-

 **DANGER**

Proceed step-by-step. Do not go to the next step unless you have completed the previous one without error / error message.

**Reaction to errors**

React to errors as follows:

- Check the system with the help of the check list in the chapter below.
- Check the LED displays on all modules. The meaning is described in the *ET 200S Distributed I/O Device Operating Instructions*.
- If required, remove individual components to trace the error.

**Reference**

Important notes can also be found in the *Debugging Functions, Diagnostics and Troubleshooting* section.

**See also**

Procedure: Commissioning the hardware (Page 143)

## 8.3 Commissioning check list

### Introduction

Once you have installed and wired up your ET 200S, we advise you to check all the previous steps once again.

The following tables give you instructions in the form of a checklist for checking your ET 200S. They also provide cross-references to sections containing additional information on the relevant topic.

### Mounting rail

The points to be checked are listed in the ET 200S Operating Instructions	<i>ET 200S Operating Instructions in section</i>
Is the rail mounted firmly to the wall, in the frame or in the cabinet?	<i>Installing</i>
Have you maintained the free space required?	<i>Installing</i>

### Concept of grounding and chassis ground

The points to be checked are listed in the ET 200S Operating Instructions	<i>ET 200S Operating Instructions in section</i>
Have you established a low-impedance connection (large surface, large contact area) to ground potential?	<i>Wiring and assembly</i>
Is the profile rail properly connected to reference potential and ground potential (direct electrical connection or ungrounded operation)?	<i>Wiring and assembly</i>
Are all grounding points of electrically connected measuring instruments and of the load power supply units connected to reference potentials?	<i>Appendix</i>

### Module installation and wiring

The points to be checked are listed in the ET 200S Operating Instructions	<i>ET 200S Operating Instructions in section</i>
Are all the terminal modules, including the terminating module, installed correctly?	<i>Installing</i>
Are all the terminal modules wired up correctly?	<i>Wiring and assembly</i>
Are all the power modules, electronic modules, ... correctly connected?	<i>Wiring and assembly</i>

## 8.4 Commissioning the modules

### 8.4.1 Inserting/Replacing a SIMATIC Micro Memory Card

#### SIMATIC Micro Memory Card (MMC) as memory module

The memory module used in your IM 151-8 PN/DP CPU interface module is a SIMATIC Micro Memory Card. You can use the SIMATIC Micro Memory Card as a load memory or a portable data medium.

---

**Note**

You must have a connected SIMATIC Micro Memory Card in order to operate the IM 151-8 PN/DP CPU interface module.

The SIMATIC Micro Memory Card is not supplied as standard with the IM 151-8 PN/DP CPU interface module.

---

**Note**

The IM 151-8 PN/DP CPU interface module goes into STOP and requests a memory reset when you remove the SIMATIC MMC while the IM 151-8 PN/DP CPU interface module is in RUN state.

---

** CAUTION**

Data on a SIMATIC Micro Memory Card can be corrupted if you remove the card while it is being accessed by a write operation. You may have to delete the SIMATIC Micro Memory Card using the PD or format it in the IM 151-8 PN/DP CPU interface module if you remove it from the live system.

DO NOT remove the SIMATIC Micro Memory Card when the system is in RUN state; always shut down power or set the IM 151-8 PN/DP CPU interface module to STOP in order to prevent any write access of a programming device. If the CPU is in STOP mode and you cannot determine whether or not a programming device function is active (e.g. load / delete block), disconnect the communication lines.

** WARNING**

Make sure that the SIMATIC Micro Memory Card to be inserted contains the proper user program for the IM 151-8 PN/DP CPU interface module (system). The wrong user program may have fatal processing effects.

## Inserting / replacing the SIMATIC Micro Memory Card

1. First of all, switch the IM 151-8 PN/DP CPU interface module to STOP.
2. Is there a SIMATIC Micro Memory Card inserted?

If yes, first of all ensure that no writing PD functions (e.g. downloading blocks) are running. If you cannot ensure this, interrupt the communication connections of the IM 151-8 PN/DP CPU interface module.

Press the ejector and remove the SIMATIC MMC.

An ejector ① is located on the frame of the module receptacle to enable you to remove the SIMATIC Micro Memory Card.

Use a small screwdriver or ball-point pen to eject.

3. Insert the ("new") SIMATIC Micro Memory Card into the receptacle so that its beveled edge points towards the ejector.
4. Gently press the SIMATIC Micro Memory Card into the IM 151-8 PN/DP CPU interface module until it engages.
5. Perform a reset (refer to section Resetting the IM 151-8 PN/DP CPU interface module using the mode selector switch (Page 151)).

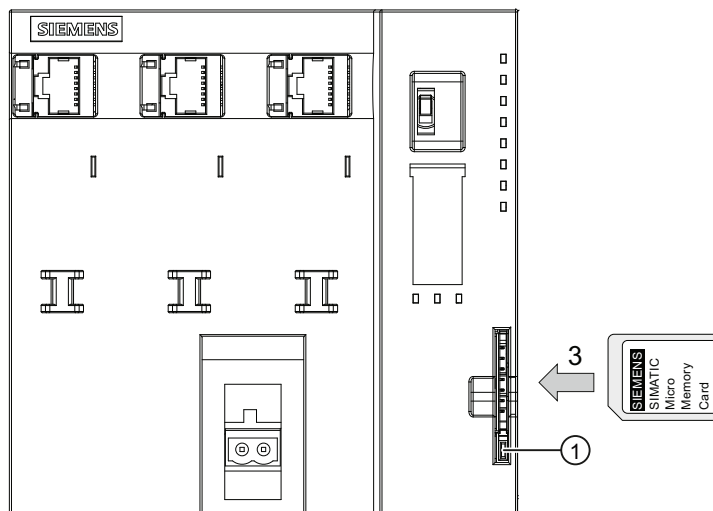

## Removing and inserting a SIMATIC Micro Memory Card

After you replace a SIMATIC MMC in POWER OFF state, the IM 151-8 PN/DP CPU interface module detects

- A physically identical SIMATIC Micro Memory Card with a different content
- A new SIMATIC Micro Memory Card with the same content as the old SIMATIC Micro Memory Card

It automatically performs a Memory reset after POWER ON.

## Reference

Additional information about the SIMATIC Micro Memory Card can be found in the S7-300, CPU 31xC and CPU 31x (<http://support.automation.siemens.com/WW/view/en/12996906>) manual, in the *Technical Data* section.

## 8.4.2 Initial power on

### Requirements

- You have installed and wired up the ET 200S.
- The SIMATIC Micro Memory Card is inserted in the IM 151-8 PN/DP CPU interface module
- The mode selector of your IM 151-8 PN/DP CPU interface module is set to STOP.

### First switch-on of an ET 200S with IM 151-8 PN/DP CPU

Switch on the supply voltage for the ET 200S.

#### Result:

On the IM 151-8 PN/DP CPU interface module

- The ON LED lights up
- the STOP LED flashes at 2 Hz when the IM 151-8 PN/DP CPU interface module is carrying out an automatic memory reset
- The STOP LED lights up after the memory reset.

### 8.4.3 Reset the IM 151-8 PN/DP CPU interface module using the mode selector switch

#### When must I perform a memory reset of the IM 151-8 PN/DP CPU interface module?

You must perform a memory reset of the IM 151-8 PN/DP CPU interface module,

- When all retentive memory bits, timers and counters have been cleared and the initial values of retentive data blocks in the load memory are to be used as actual values in the work memory.
- if the retentive memory bits, timers and counters could cause unwanted responses after "Load user program onto memory card" with the user program just downloaded to the IM 151-8 PN/DP CPU interface module.

Reason: "Load user program onto memory card" does not delete the retentive areas.

- if the IM 151-8 PN/DP CPU interface module requests a memory reset with its STOP LED flashing at 0.5 Hz intervals. Possible reasons for this request are listed in the table below.

Table 8- 3 Possible causes for a request to memory reset by the IM 151-8 PN/DP CPU interface module

Causes for a request to memory reset by the IM 151-8 PN/DP CPU interface module	Special features
The SIMATIC Micro Memory Card has been replaced.	–
RAM error in the IM 151-8 PN/DP CPU interface module	–
Work memory is too small, i.e. not all the blocks of the user program on a SIMATIC Micro Memory Card can be loaded.	IM 151-8 PN/DP CPU interface module with SIMATIC Micro Memory Card inserted: This causes continuous requests for a memory reset. This may be prevented by formatting the SIMATIC Micro Memory Card (see Formatting the SIMATIC Micro Memory Card (Page 155)). For additional information on the way the SIMATIC Micro Memory Card responds to a memory reset, see Memory reset and restart (Page 121).
Attempts to load faulty blocks; if a wrong instruction was programmed, for example.	

#### How to reset memory

There are two ways to reset the IM 151-8 PN/DP CPU interface module memory:

Memory reset using the mode selector switch	Memory reset using the programming device
... is described in this section.	... is only possible when IM 151-8 PN/DP CPU interface module is in STOP mode (see <i>STEP 7 Online Help</i> ).

### Resetting the memory of the IM 151-8 PN/DP CPU using the mode selector switch

The following table contains the steps required to memory reset the IM 151-8 PN/DP CPU interface module.

Table 8-4 Steps for performing a memory reset of the IM 151-8 PN/DP CPU interface module

Step	Resetting the memory of the IM 151-8 PN/DP CPU
1.	Turn the key to STOP position ①
2.	Turn the key to MRES position Hold the key in this position until the STOP LED lights up for the second time and remains on (this takes 3 seconds). ② Now release the key.
3.	You must turn the key to MRES position again within 3 seconds and hold it there until the STOP LED flashes (at 2 Hz). ③ You can now release the switch. When the IM 151-8 PN/DP CPU interface module has completed the memory reset, the STOP LED stops flashing and lights up. The memory reset has been carried out on the IM 151-8 PN/DP CPU interface module.

The procedure described in the table above is only required if you wish to reset the IM 151-8 PN/DP CPU interface module memory without this being requested by the IM 151-8 PN/DP CPU interface module (STOP LED flashing slowly). If the IM 151-8 PN/DP CPU interface module prompts you for a memory reset, you only have to turn the mode selector briefly to the MRES position to initiate the memory reset operation.

The figure below shows how to use the mode selector switch to reset the IM 151-8 PN/DP CPU interface module memory:

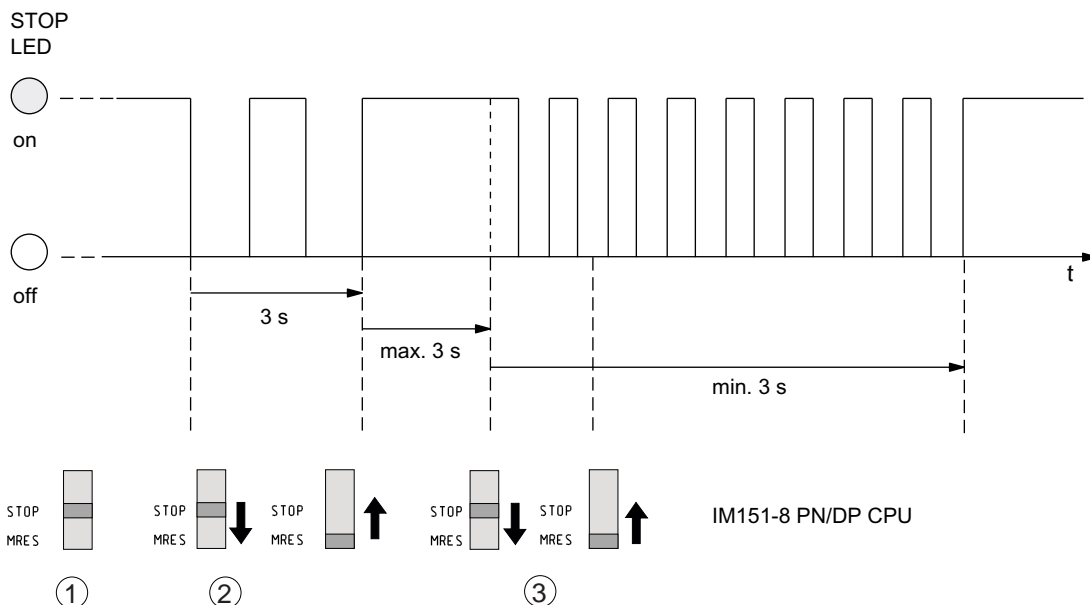

If the IM 151-8 PN/DP CPU interface module prompts you for another memory reset following a successful memory reset operation, the SIMATIC Micro Memory Card may need to be reformatted see section (Formatting the Micro Memory Card (Page 155)).



### STOP LED does not flash during the memory reset

What should I do if the STOP LED does not flash during the memory reset or if other LEDs are lit?

1. You must repeat steps 2 and 3.
2. If the IM 151-8 PN/DP CPU interface module does not perform a memory reset again, you must evaluate the diagnostics buffer of the IM 151-8 PN/DP CPU interface module.

### What happens to the IM 151-8 PN/DP CPU interface module with a memory reset?

Table 8- 5 Internal processes in the IM 151-8 PN/DP CPU during a memory reset

Event	Action in the IM 151-8 PN/DP CPU interface module
Process in the IM 151-8 PN/DP CPU interface module	1. The IM 151-8 PN/DP CPU interface module deletes the entire user program in the work memory.
	2. The IM151-8 PN/DP CPU interface module deletes the retentive user data (flags, times, counters and DB contents).
	3. The IM 151-8 PN/DP CPU interface module tests its hardware.
	4. The IM 151-8 PN/DP CPU interface module copies the sequence-related content of the SIMATIC Micro Memory Card (load memory) to the work memory. <b>Tip:</b> If the IM 151-8 PN/DP CPU interface module is unable to copy the content of the SIMATIC Micro Memory Card and requests a memory reset, then: <ul style="list-style-type: none"> <li>• Remove the SIMATIC Micro Memory Card</li> <li>• Resetting the memory of the IM 151-8 PN/DP CPU</li> <li>• Read the diagnostics buffer</li> </ul> <p>If the IP address and device name were not retentive (depending on how they were assigned): Provide the IM 151-8 PN/DP CPU interface module with a temporary IP address and then read out the diagnostics buffer or in the SIMATIC-Manager under "Available nodes", establish the MAC address of the IM 151-8 PN/DP CPU interface module. When the Ethernet interface of the PD is set to "TCP/IP (Auto)", you can read out the diagnostics buffer also via this available MAC address, because then <i>STEP 7</i> assigns a temporary IP address.</p>
Memory contents after reset	The user program is transferred back from the SIMATIC Micro Memory Card to the work memory and the memory utilization is indicated accordingly.
What's left?	<ul style="list-style-type: none"> <li>• Parameters of the PN interface: IP address parameters / device name (depending on how they were assigned, see section Assignment of IP address parameters and device name (Page 139)).</li> </ul>
	<ul style="list-style-type: none"> <li>• Data in the diagnostics buffer. (Only the last 100 entries in the diagnostics buffer are retained in the event of a POWER OFF / POWER ON.) You can read the diagnostics buffer with the programming device (see <i>STEP 7 Online Help</i>).</li> </ul>
	<ul style="list-style-type: none"> <li>• The content of the operating hours counter and the time.</li> </ul>

**Note**

**Communication shutdown during memory reset on PROFINET CPUs with integrated switch**

Note that the PROFINET interface and the integrated switch are shut down when you reset memory on this CPU.

During the memory reset on a CPU configured within a line structure, communication via the CPU's integrated switch to downstream devices is shut down.

A restart of the PROFINET interface is performed after a memory reset, only if the interface parameters are stored retentively.

The integrated switch is always restarted and can resume communication on completion of the CPU memory reset.

**Special feature: Interface parameters**

The table below describes which interface parameters are valid after a CPU memory reset.

Memory reset ...	PROFINET interface parameters ...	DP parameters with DP master module inserted
<b>with</b> inserted SIMATIC Micro Memory Card	... the MPI parameters on the SIMATIC Micro Memory Card or integrated read-only load memory are valid.	
	If no parameters are stored (SDB), the parameters previously set are valid providing they were retentively stored (depending on how they were assigned, see section: Assignment of the IP address parameters and device name (Page 139))	If no parameters are stored here (SDB), neither are any DP interface parameters present.
<b>without</b> inserted SIMATIC Micro Memory Card	... the parameters previously set are valid providing they were retentively stored (depending on how they were assigned, see section: Assignment of the IP address parameters and device name (Page 139))	... neither are any DP interface parameters present.

## 8.4.4 Formatting the SIMATIC Micro Memory Card

### You must format the SIMATIC Micro Memory Card in the following cases

- The SIMATIC Micro Memory Card module type is not a user module.
- The SIMATIC Micro Memory Card has not been formatted.
- The SIMATIC Micro Memory Card is defective.
- The content of the SIMATIC Micro Memory Card is invalid.  
The content of the SIMATIC Micro Memory Card has been identified as invalid.
- The "Load user program" operation was interrupted as a result of POWER OFF.
- The "Write RAM to ROM" operation was interrupted as a result of POWER OFF.
- Error when evaluating the module content during Memory reset.
- Formatting error, or formatting failed.

If one of these errors has occurred, the IM 151-8 PN/DP CPU interface module prompts for yet another memory reset, even after the memory has already been reset. The card's content is retained until the SIMATIC Micro Memory Card is formatted, unless the "Load user program" or "Write RAM to ROM" operation was interrupted as a result of POWER OFF.

The SIMATIC Micro Memory Card is only formatted if there is a reason to do so (see above) and not, for example, when you are prompted for a memory reset after a module is changed. In this case, a switch to MRES triggers a normal memory reset for which the module content remains valid.

### Use the following steps to format your SIMATIC Micro Memory Card

If the IM 151-8 PN/DP CPU interface module is requesting a memory reset (STOP LED flashing slowly), you can format the SIMATIC Micro Memory Card as follows:

1. Toggle the switch to the MRES position and hold it there until the STOP LED lights up and remains on (after approx. 9 seconds).
2. Within the next three seconds, release the switch and toggle it once again to MRES position. The STOP LED flashes to indicate that formatting is in progress.

---

#### Note

Always perform this sequence of operation within the specified time. Otherwise, the SIMATIC Micro Memory Card will not be formatted, but rather returns to memory reset status.

---

### See also

Reset the IM 151-8 PN/DP CPU interface module using the mode selector switch (Page 151)

### 8.4.5 Resetting to the as-delivered state

#### Setting the IM 151-8 PN/DP CPU interface module back to factory settings

In the factory settings, the properties of the IM 151-8 PN/DP CPU interface module are set to the following values:

Table 8- 6 Properties of the IM 151-8 PN/DP CPU interface module factory settings

Properties	Value
Retentive memory bits, timers, counters	All retentive memory bits, timers and counters are cleared
Set retentive area for memory bits, timers and counters	Default setting (16 memory bytes, no timers, 8 counters)
Contents of the diagnostics buffer	cleared
Operating hours counter	0
Time-of-day	1.1.1994 00:00:00
IP address and device name	Not available

#### Procedure

Proceed as follows to reset a IM 151-8 PN/DP CPU interface module to the factory settings using the mode selector:

1. Switch off the power supply.
2. Remove the SIMATIC Micro Memory Card from the receptacle (see Inserting/replacing a Micro Memory Card (Page 148))
3. Keep the mode selector switch in the MRES position and switch the power supply on again.
4. Wait until LED lamp image 1 from the subsequent overview is displayed.
5. Release the mode selector switch, set it back to MRES within 3 seconds and hold it in this position.
6. The LED lamp image 2 from the subsequent overview is displayed. This lamp image lights up while the reset operation is running (approximately 5 seconds). During this period you can cancel the resetting procedure by releasing the mode selector.
7. Wait until LED lamp image 3 from the following overview is displayed and release the mode selector again.

The IM 151-8 PN/DP CPU interface module is reset to the factory settings. It runs unbuffered (all the LEDs light up, apart from P1 - LINK, P2 - LINK and P3 - LINK) and changes to STOP mode.

### Lamp images while resetting the IM 151-8 PN/DP CPU interface module

While you are resetting the IM 151-8 PN/DP CPU interface module to the factory settings, the LEDs light up in succession in the following lamp images:

Table 8- 7 Lamp images

LED	Color	Lamp image 1	Lamp image 2	Lamp image 3
SF	Red	□	○	△
BF-PN	Red	□	□	□
MT	Yellow	□	□	□
ON	Green	△	△	△
FRCE	Yellow	○	□	□
RUN	Green	○	□	□
STOP	Yellow	○	□	□
P1 - LINK	Green	□	□	□
P2 - LINK	Green	□	□	□
P3 - LINK	Green	□	□	□
<b>Legend:</b> △ = LED lit; □ = LED dark; ○ = LED flashes at 0.5 Hz				

#### Note

If you remove an (operational) IO device and re-use it in another place or place it in storage, the IO device should be restored to its as-delivered condition, since the IP address of the device will generally be stored retentively.

### 8.4.6 Connecting a programming device / PC to the integrated PROFINET interface of the IM 151-8 PN/DP CPU interface module

#### Requirement

- IM 151-8 PN/DP CPU with integrated PROFINET interface
- Programming device / PC with network card

#### Connecting a programming device / PC to the integrated PROFINET interface of the IM 151-8 PN/DP CPU interface module

1. Connect the programming device / PC to the X1 P1 interface of the IM 151-8 PN/DP CPU interface module using a pre-assembled, uncrossed twisted pair cable ①.

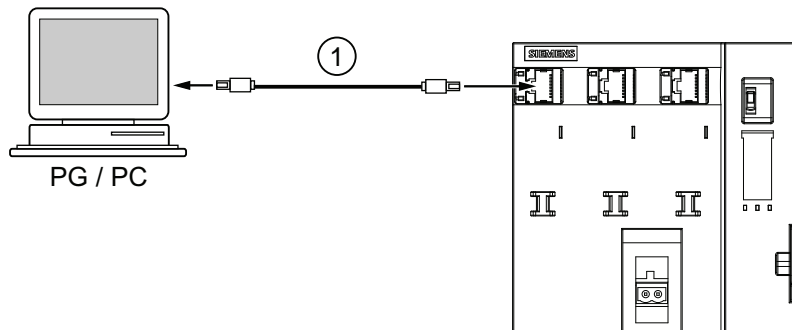

A programming device can also be connected and used at the other two ports of the PROFINET interface.

#### Result

You have connected your programming device / PC to the integrated PROFINET interface of the IM 151-8 PN/DP CPU interface module.

## Configuring the PROFINET interface of the IM 151-8 PN/DP CPU interface module

If you wish to connect only a programming device and no IO devices to the IM 151-8 PN/DP CPU interface module, you must also configure the PROFINET interface accordingly.

Procedure:

Step	Activity
<b>Configuring hardware in STEP 7 SIMATIC Manager</b>	
1	Select <b>File &gt; New...</b> Enter a name for your project and click on "OK" to confirm.
2	Select <b>Insert &gt; Station &gt; SIMATIC 300 Station</b> to add an S7-300 station.
3	Double-click "Hardware." <b>Result:</b> HW Config opens.
4	Insert your IM 151-8 PN/DP CPU interface module using drag-and-drop. <b>Result:</b> The "Properties – Ethernet Interface PN-IO" window opens. The properties of the PROFINET interface X1 are shown in the "Parameters" tab.
<b>Assigning the IP address</b>	
5	Enter the required IP address in the window.
6	Click "OK" to close the Properties dialog box.
<b>Saving the configuration</b>	
7	Save your configuration with <b>Station &gt; Save and compile.</b>
<b>Configuration download</b>	
8	<p>Download the configuration to the IM 151-8 PN/DP CPU interface module. There are two ways of doing this:</p> <ul style="list-style-type: none"> <li>• online via the PN interface  <p>To download the configuration, select the MAC address of the target IM 151-8 PN/DP CPU interface module. You can display the list of available nodes in the "Select node address" window whilst downloading the HW configuration. Here you can select the desired target device via the associated IP or MAC address. If the device has only had a MAC address so far, then this can now be assigned the configured IP address.                      The programming device must be connected to the IM 151-8 PN/DP CPU interface module in order to do this. The programming device interface must be set to <b>TCP/IP (Auto)</b>. In the <b>IE-PG Access</b> tab of the interface properties you must set: <b>Assign Project-Specific IP Address.</b></p> </li> <li>• offline, by saving the data to a SIMATIC Micro Memory Card in SIMATIC Manager on your programming device, and then inserting the SIMATIC Micro Memory Card into the IM 151-8 PN/DP CPU interface module</li> </ul>

## Result

You have assigned a retentive IP address to the PROFINET interface of the IM 151-8 PN/DP CPU interface module.

## Reference

- Other methods of assigning the IP address can be found in the section Assignment of the IP address parameters and device name (Page 139).
- Information on PROFINET can be found in the PROFINET (<http://support.automation.siemens.com/WW/view/en/19292127>) System Description.
- For information on passive network components such as switches, refer to the SIMATIC NET manual: Twisted Pair and Fiber-Optic Networks (<http://support.automation.siemens.com/WW/view/en/8763736>).

## See also

Configuring and commissioning the PROFINET IO system (Page 173)

## 8.4.7 Starting SIMATIC Manager

### Introduction

SIMATIC Manager is a GUI for online/offline editing of S7 objects (projects, user programs, blocks, hardware stations and tools).

The SIMATIC Manager lets you

- Manage projects and libraries,
- Call *STEP 7* tools,
- Access the PLC (AS) online,
- Editing SIMATIC Micro Memory Cards.

### Starting SIMATIC Manager

After installation, the **SIMATIC Manager** icon appears on the Windows desktop, and the Start menu contains entry **SIMATIC Manager** under **SIMATIC**.

1. Run SIMATIC Manager by double-clicking the icon, or from the Start menu (same as with all other Windows applications).

### User interface

A corresponding editing tool is started up when you open the relevant objects. You start the program editor by double-clicking the program block you want to edit (object-oriented start).

### Online Help

The online help for the active window is always called by pressing F1.



## 8.4.8 Monitoring and modifying I/Os

### The "Monitor and modify variables" tool

The *STEP 7* "Monitor and modify variables" tool lets you:

- Monitor program variables in any format
- Editing (modifying) the status or content of variables in the IM 151-8 PN/DP CPU interface module.

### Creating a variable table

You have two options of creating a variable table (VAT):

- In the LAD / FBD / STL editor by selecting the **PLC > Monitor/Modify Variables** command  
This table is also available directly online.
- In the SIMATIC Manager with the **Blocks** container open via menu item **Insert New Object > Variable table**

This table created offline can be saved for future retrieval. You can also test it after switching to online mode.

#### VAT structure:

In the VAT, every address to be monitored or modified (e.g. inputs, outputs) occupies one row.

The meaning of the VAT columns is as follows:

Column text	In this field ...
Address	contains the absolute address of the variable
Icon	contains the symbolic descriptor of the variables This is identical to the specification in the Symbol Table.
Symbol comment	shows the symbol comment of the Symbol Table
Status format	contains the default format setting, e.g. HEX. You can change the format as follows: <ul style="list-style-type: none"> <li>• right-click in the format field. The Format List opens.</li> <li>or</li> <li>• left-click in the format field until the relevant format appears</li> </ul>
Status value	shows the content of the variable at the time of update
Modify value	is used to enter the new variable value (modify value)

### Monitor variable

You have two options for monitoring variables:

- Updating the status values once via menu item **Variable > Update Status Values**  
or
- Continuous update of status values via menu item **Variable > Monitor**

### Modifying variables

To modify variables, proceed as follows:

1. Left-click the field **Modify value** of the relevant variable.
2. Enter the modify value according to the data type.
3. To update modify values once, select the menu item **Variable > Activate Modify Value**.

or

Enable modify values permanently via menu item **Variable > Modify**.

4. In the **Monitor** test function, verify the modify value entry in the variable.

#### Is the modify value valid?

You can disable the modify value entered in the table. An invalid value is displayed same as a comment. You can re-enable the modify value.

Only valid modify values can be enabled.

### Setting the trigger points

#### Trigger points:

- The "Trigger point for monitoring" determines the time of update for values of variables to be monitored.
- The "Trigger point for modifying" determines the time for assigning the modify values to the variables to be modified.

#### Trigger condition:

- The "Trigger condition for monitoring" determines whether to update values once when the trigger point is reached or continuously every time the trigger point is reached.
- The "Trigger condition for modifying" determines whether to assign modify values once or permanently to the variable to be modified.

You can customize the trigger points using the tool "Monitoring and Modifying Variables" in the menu item **Variable > Set Trigger...**

#### Special features

- If "Trigger condition for monitoring" is set to **once**, the menu items **Variable > Update Status Values** or **Variable > Monitor** have the same effect, namely a single update.
- If "Trigger condition for modifying" is set to **once**, the menu items **Variable > Update Status Values** or **Variable > Modify** have the same effect, namely a single assignment.
- If trigger conditions are set to **permanent**, the said menu items have different effects as described above.
- If monitoring and modifying is set to the same trigger point, monitoring is executed first.
- If **Process mode** is set under **Debug > Mode**, values are not cyclically updated when **permanent modifying** is set.

To correct or avoid error: Use the **Force** test function.

## Saving/opening the variable table

### Saving the VAT

1. After aborting or completing a test phase, you can save the variable table to memory. The name of a variable table starts with the letters VAT, followed by a number from 0 to 65535; e.g. VAT5.

### Opening VAT

1. Select the menu item **Table > Open**.
2. Select the project name in the **Open** dialog.
3. In the project window below, select the relevant program and mark the **Blocks** container.
4. In the block window, select the desired table.
5. Confirm with **OK**.

## Creating a connection to the IM 151-8 PN/DP CPU interface module

The variables of a VAT represent dynamic quantities of a user program. To monitor or modify variables, you will need to establish a connection with the relevant IM 151-8 PN/DP CPU interface module. Every variable table can be linked to another IM 151-8 PN/DP CPU interface module.

Use the **PLC > Connect to ...** menu item to establish a connection to one of the following IM 151-8 PN/DP CPU interface modules:

- configured IM 151-8 PN/DP CPU interface module
- directly connected IM 151-8 PN/DP CPU interface module
- available IM 151-8 PN/DP CPU interface module

The table below lists the display of variables.

Interface modules	The variables of the IM 151-8 PN/DP CPU interface module are displayed, ...
configured IM 151-8 PN/DP CPU interface module	in S7 program (hardware station) of which the variable table is stored.
directly connected IM 151-8 PN/DP CPU interface module	that is connected directly to the programming device.
available IM 151-8 PN/DP CPU interface module	that is selected in the dialog window. Use the <b>PLC &gt; Connect to ... &gt; Available CPU ...</b> menu item to connect to an available IM 151-8 PN/DP CPU interface module. With this you can create a connection to any IM 151-8 PN/DP CPU interface module in the network.

### Controlling outputs in STOP of the IM 151-8 PN/DP CPU interface module

The function **Enable PO** resets the output disable signal for the peripheral outputs (PO). This enables you to control the PO when the IM 151-8 PN/DP CPU interface module is in STOP mode.

In order to enable the POs, proceed as follows:

1. Select **Table > Open the variable table (VAT)** to open the variable table containing the POs you want to modify, or activate the window containing the corresponding VAT.
2. To control the POs of the active VAT, select the required IM 151-8 PN/DP CPU interface module connection using the **PLC > Connect to ...** menu item.
3. Use the **PLC > Operating Mode** menu item to open the **Operating Mode** dialog and switch the IM 151-8 PN/DP CPU interface module to STOP mode.
4. Enter your values in the "Modify value" column for the PO you want to modify.

Examples:

PO: POB 7 modify value: 2#0100 0011  
POW 2 W#16#0027  
POD 4 DW#16#0001

5. Select **Variable > Enable PO** to set "Enable PO" mode.
6. Modify the PO by selecting **Variable > Activate Modify Values**. "Enable PO" mode remains active until reset by selecting **Variable > Enable PO** once mode.

"Enable PO" is also terminated when the connection to the programming device is dropped.

7. Return to step 4 if you want to set new values.

---

#### Note

If the IM 151-8 PN/DP CPU interface module changes its mode, for example, from STOP to RUN or STARTUP, a message is shown.

A message is also shown if the IM 151-8 PN/DP CPU interface module is set to "Enable PO" function while the IM 151-8 PN/DP CPU interface module is in RUN mode.

---

---

#### Note

I/O output modules that were configured for use of the IM as an I device in the I/O transfer area, cannot be controlled after PA disconnection.

---

## 8.5 Commissioning PROFIBUS DP

### 8.5.1 Commissioning the PROFIBUS DP network

#### Requirements

Requirements for commissioning a PROFIBUS DP network:

- The IM 151-8 PN/DP CPU interface module can be expanded by one DP master module.
- A PROFIBUS DP network is installed.
- You have configured the PROFIBUS DP network using *STEP 7* and have assigned a PROFIBUS DP address and the address space to all the nodes.
- Note that you must also set address switches for some of the DP slaves (see the description of the relevant DP slave).
- The software as shown in the following table is required for the IM 151-8 PN/DP CPU interface module:

Table 8- 8 Software requirements for the IM 151-8 PN/DP CPU interface module

Interface module	Order number	Software required
IM 151-8 PN/DP CPU	6ES7151-8AB01-0AB0	<i>STEP 7</i> V5.5 and higher

#### DP address areas of the IM 151-8 PN/DP CPU interface module

Table 8- 9 DP address areas of the IM 151-8 PN/DP CPU interface module

Address area	IM 151-8 PN/DP CPU
Entire address range of inputs and outputs	2048 bytes
Number of those in process image for I/Os	Bytes 0 to 2047 (can be set)
	Bytes 0 to 127 (preset)

## DP diagnostics addresses

DP diagnostic addresses occupy 1 byte per DP master and DP slave in the input address range. For example, at these addresses DP standard diagnostics can be called for the relevant node (LADDR parameter of SFC 13). The DP diagnostics addresses are specified in your configuration. If you do not specify any DP diagnostic addresses, *STEP 7* assigns these DP diagnostics addresses in descending order, starting at the highest byte address.

If there is an IM 151-8 PN/DP CPU interface module with DP master module as the master, assign two different diagnostics addresses for S7 slaves:

- Diagnostics address of the slave (address for slot 0)

At this address all slave events are reported in the DP master (node proxy), e.g. node failure.

- Diagnostics address of the module (address for slot 2)

All module (STOP / RUN transition of an IM 151-7 CPU as an intelligent DP slave, for example) events are reported in the master (OB 82) at this address.

## 8.5.2 Commissioning the IM 151-8 PN/DP CPU interface module with DP master module as a DP master

### Requirements for commissioning

- A DP master module is connected to the IM 151-8 PN/DP CPU interface module.
- The PROFIBUS subnet has been configured.
- The DP slaves are ready for operation (see relevant DP slave manuals).
- Before commissioning, you must configure the IM 151-8 PN/DP CPU interface module as a DP master. That means that, in *STEP 7* you must
  - configure the IM 151-8 PN/DP CPU interface module as a DP master,

---

#### Note

You must suspend the DP master module separately as a submodule (X2) in the station window in HW Config.

---

- assign a PROFIBUS address to the DP interface on the DP master module,
- assign a master diagnostics address to the DP interface on the DP master module,
- Integrate the DP slaves into the DP master system

Is the DP CPU a DP slave?

If so, this DP slave will appear in the PROFIBUS DP catalog as an **already configured station**. In the DP master, assign a slave diagnostics address to this DP slave CPU. You must interconnect the DP master with the DP slave CPU and specify the address areas for data exchange with the DP slave CPU.

## Commissioning

Commission the IM 151-8 PN/DP CPU interface module with DP master module as a DP master in the PROFIBUS subnet as follows:

1. Download the PROFIBUS subnet configuration created with *STEP 7* (preset configuration) from the programming device to the IM 151-8 PN/DP CPU interface module.
2. Switch on all the DP slaves.
3. Switch the IM 151-8 PN/DP CPU interface module from STOP to RUN.

### Behavior of the IM 151-8 PN/DP CPU interface module during commissioning

- The DP master module is installed and IM 151-8 PN/DP CPU interface module is configured as a DP master  
⇒ the IM 151-8 PN/DP CPU interface module switches to RUN with master functionality
- The DP master module is installed and the IM 151-8 PN/DP CPU interface module is not configured as a DP master  
⇒ the IM 151-8 PN/DP CPU interface module switches to RUN without master functionality

### Starting up the IM 151-8 PN/DP CPU interface module as a DP master

During startup, the IM 151-8 PN/DP CPU interface module checks the configured preset configuration of its DP master system against the actual configuration.

If the preset configuration = the actual configuration, the IM 151-8 PN/DP CPU interface module goes to RUN.

If the preset configuration ≠ the actual configuration, the configuration of parameter **Startup if preset configuration ≠ actual configuration** determines the startup behavior of the IM 151-8 PN/DP CPU interface module.

Startup when the preset configuration ≠ actual configuration = Yes (default setting)	Startup when the preset configuration ≠ actual configuration = no
IM 151-8 PN/DP CPU in RUN (BF LED flashes if any of the DP slaves cannot be addressed).	The IM 151-8 PN/DP CPU interface module remains in STOP mode, and the BF LED flashes after the set <b>Monitoring time for transfer of parameters to modules</b> .  The flashing BF LED indicates that at least one DP slave cannot be addressed. In this case, check that all the DP slaves are switched on and correspond with your configuration, or read out the diagnostics buffer with <i>STEP 7</i> .

### Recognizing the operating state of DP slaves (Event recognition)

The table below shows how the IM 151-8 PN/DP CPU interface module with DP master module acting as a DP master recognizes operating mode transitions of a CPU acting as a DP slave or any interruption of the data exchange.

Table 8- 10 Event recognition of the IM 151-8 PN/DP CPU interface module as a DP master

Event	What happens in the DP master?
Bus interruption (short circuit, connector removed)	<ul style="list-style-type: none"> <li>• Call of OB86 with the message <b>Station failure</b> (incoming event; diagnostics address of the DP slave assigned to the DP master)</li> <li>• With I/O access: Call of OB 122 (I/O access error)</li> </ul>
DP slave: RUN → STOP	<ul style="list-style-type: none"> <li>• Call of OB 82 with the message <b>Module error</b> (incoming event; diagnostics address of the DP slave assigned to the DP master; Variable OB82_MDL_STOP=1)</li> </ul>
DP slave: STOP → RUN	<ul style="list-style-type: none"> <li>• Call of OB82 with the message <b>Module OK</b> (outgoing event; diagnostics address of the DP slave assigned to the DP master; variable OB82_MDL_STOP=0)</li> </ul>

**Tip:**

When commissioning the IM 151-8 PN/DP CPU interface module as the DP master, always program OB 82 and OB 86. This helps you to recognize and evaluate data exchange errors or interruptions.

### Constant Bus Cycle Time

This is a property of PROFIBUS DP that ensures bus cycles of exactly the same length. The "Constant bus cycle time" function ensures that the DP master always starts the DP bus cycle after a constant interval. From the perspective of the slaves, this means that they receive their data from the master at constant time intervals.

In *Step 7* HW config, you can configure constant bus cycle times for PROFIBUS subnets. A detailed description of the constant bus cycle time can be found in the *STEP 7 Online Help*.

### Time synchronization

Information about time synchronization via PROFIBUS DP can be found under *Interfaces > PROFIBUS DP*.



## SYNC/FREEZE

The **SYNC** control command is used to set the DP slaves of a group to sync mode. In other words, the DP master transfers the current output data and instructs the relevant DP slaves to freeze their outputs. The DP slaves write the output data of the next output frames to an internal buffer; the state of the outputs remains unchanged.

After each SYNC control command, the DP slaves of the selected groups transfer the output data stored in their internal buffer to the process outputs.

The outputs are only updated cyclically again after you transfer the UNSYNC control command using SFC11 "DPSYC\_FR".

The **FREEZE** control command is used to set the relevant DP slaves to Freeze mode. In other words, the DP master instructs the DP slaves to freeze the current state of the inputs. It then transfers the frozen data to the input area of the IM 151-8 PN/DP CPU interface module.

Following each FREEZE control command, the DP slaves freeze the state of their inputs again.

The DP master does not receive the current state of the inputs cyclically once more until you have sent the UNFREEZE control command with SFC11 "DPSYC\_FR".

SFC 11 is described in the *STEP 7 online help* and in the *System and Standard Functions for S7-300/400* reference manual.

## Powering up the DP master system

IM 151-8 PN/DP CPU as a DP master
Set the power-up monitoring time for DP slaves using the <b>Monitoring time for parameter transfer to modules</b> parameter.
This means that the DP slaves must power up within the set time and must be set by the IM 151-8 PN/DP CPU interface module (as DP master).

## PROFIBUS address of the DP master

For the IM 151-8 PN/DP CPU interface module you **must not set "126"** as a PROFIBUS address.

## See also

PROFIBUS DP (Page 32)

### 8.5.3 Direct data exchange

#### Requirement

In *Step 7* HW config, you can configure "Direct Data Exchange" for PROFIBUS nodes. The IM 151-8 PN/DP CPU interface module with DP master module participate in a direct data exchange as a receiver.

#### Definition

"Direct data exchange" is a special communication relationship between PROFIBUS DP nodes.

Direct data exchange is characterized by the fact that the PROFIBUS DP nodes "listen" on the bus for data that a DP slave returns to its DP master. This mechanism allows the "listening node" (recipient) direct access to deltas of input data of remote DP slaves.

#### Address Areas

During configuration in *STEP 7*, use the I/O input addresses to specify the address area of the recipient at which the sender's data should be read.

The IM 151-8 PN/DP CPU interface module with DP master module can be a receiver:

- as a DP master
- as a CPU that is not integrated in a master system

### Example: Direct data exchange via DP CPUs

The example in the figure below shows the relationships you can configure for direct data exchange. All the DP masters and DP slaves (apart from slave 3 and slave 5) are in each case a DP-CPU, whereby the IM 151-8 PN/DP CPU interface module can be just a DP master. Note that other DP slaves (ET 200M, ET 200S, ET 200pro) can only operate as transmitters.

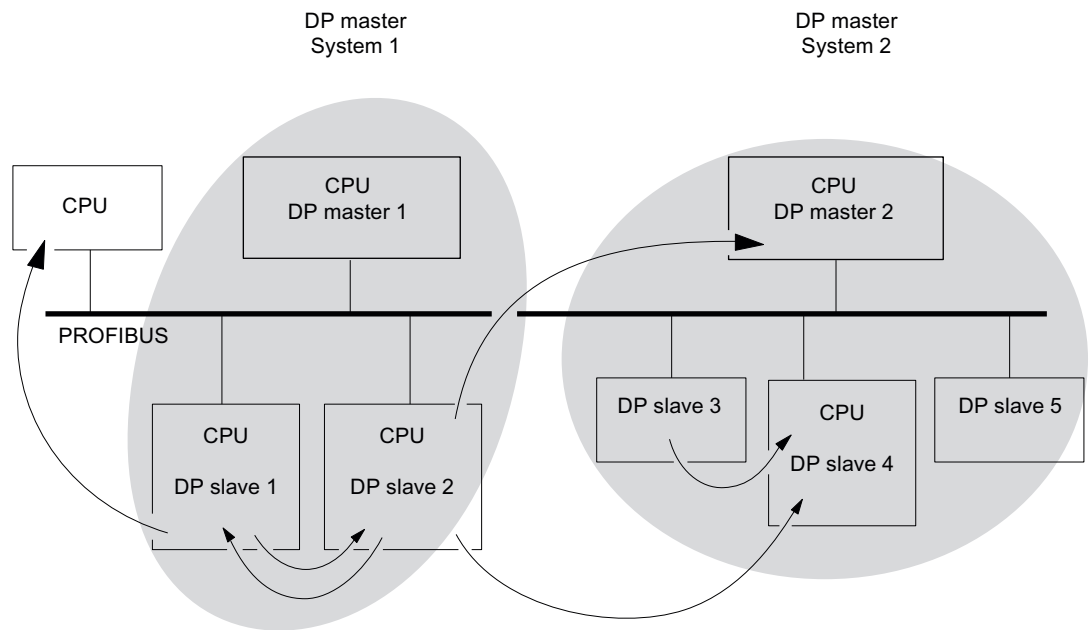

## 8.6 Commissioning PROFINET IO

### 8.6.1 Requirements for commissioning PROFINET

#### Requirements

Requirements to be satisfied before you can start to commission your PROFINET IO system:

ET 200S with ...	Software required	PROFINET IO system installed
IM 151-8 PN/DP CPU	STEP 7 V5.5 and higher	X

#### PROFINET IO address areas of the IM 151-8 PN/DP CPU interface module

Table 8- 11 PROFINET IO address areas of the IM 151-8 PN/DP CPU interface module

Address area	IM 151-8 PN/DP CPU
Entire address range of inputs and of outputs	2048 bytes
Number of those in process image for I/Os	Bytes 0 to 2047 (can be set)
	Byte 0 to 127 (preset)

In the input address area, **diagnostics addresses** each take up 1 byte for

- The IO controller
- the PROFINET interface and its ports and each IO device (header module at slot 0),
- each module / submodule without user data within the device (e.g. ET 200S power module or ports of the PROFINET interface).

You can use these addresses, for example, to read module-specific diagnostics data records by calling SFB 52. The diagnostics addresses are specified in your configuration. If you do not specify any diagnostics addresses, *STEP 7* assigns these addresses in descending order, starting from the highest byte address.

## 8.6.2 Configuring and commissioning the PROFINET IO system

### Overview

There are several ways to start commissioning the PROFINET IO interface of the IM 151-8 PN/DP CPU interface module, and then the PROFINET IO system:

- online via the PN interface
- offline, by saving the data to a SIMATIC Micro Memory Card in SIMATIC Manager on your programming device, and then inserting the SIMATIC Micro Memory Card into the IM 151-8 PN/DP CPU interface module

### Commissioning a PROFINET IO system directly via PN interface

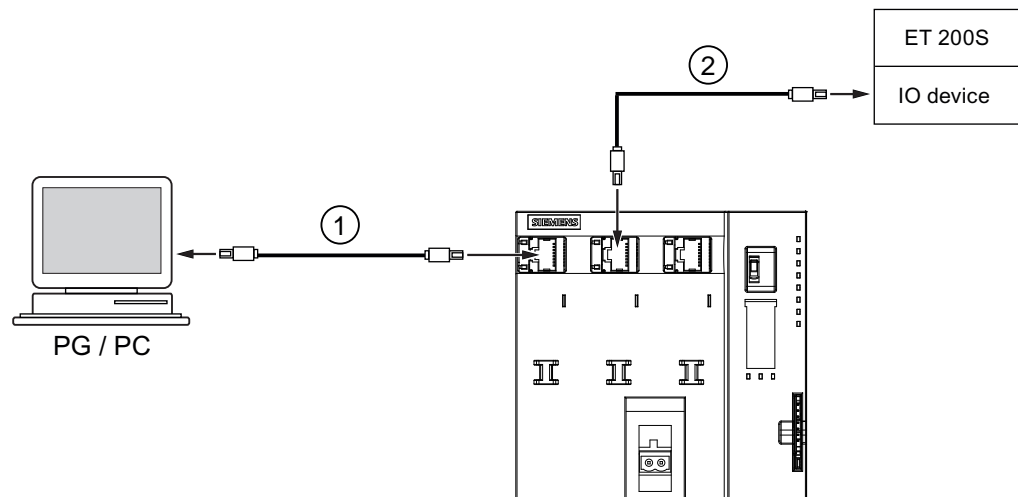

#### Number Meaning

- ① Connect the programming device / PC to the X1 P1 interface of the IM 151-8 PN/DP CPU interface module using a pre-assembled, uncrossed twisted pair cable.
- ② Use a pre-assembled, uncrossed twisted pair cable to connect the IO device (e.g. ET 200S) to the integrated PROFINET interface X1 P2 of your IM 151-8 PN/DP CPU interface module. The IO device can also be connected to X1 P3. It is also possible to interpose a switch.

### Commissioning requirements:

- The IM 151-8 PN/DP CPU interface module is in STOP mode.
- The IO devices are switched on.
- The PROFINET subnet is installed, and the communication partners (programming device, IO controller, IO devices, for example) are connected to the PROFINET subnet.

## Configuring the PROFINET IO system

Step	Activity
<b>Configuring hardware in STEP 7 SIMATIC Manager</b>	
1	Select <b>File &gt; New...</b> Enter a name for your project and click on OK to confirm.
2	Select <b>Insert &gt; Station &gt; SIMATIC 300 Station</b> to add an S7-300 station.
3	Double-click "Hardware." <b>Result:</b> HW Config opens.
4	Insert your IM 151-8 PN/DP CPU interface module using drag-and-drop. <b>Result:</b> The "Properties – Ethernet Interface PN-IO" window opens. The properties of the PROFINET interface X1 are shown in the "Parameters" tab.
<b>Assigning the IP address (example: Assignment of a retentive IP address)</b>	
5	Click "New" on the "Properties – Ethernet Interface PN-IO" dialog box to create a new subnet. <b>Result:</b> The "Properties – New Industrial Ethernet Subnet" dialog box opens.
6	Assign a name and confirm with "OK." <b>Result:</b> You are back to the "Properties – Ethernet Interface PN-IO" dialog box.
7	Enter the IP address and the subnet mask in the dialog box. This information is available from your network administrator.
8	If you setup a connection via router, you must also enter the address of the router. This information is also available from your network administrator.
9	Click "OK" to close the Properties dialog box.
<b>Configuring the PROFINET IO system</b>	
10	Insert the IO devices at the PROFINET IO system, for example, an IM 151-3 PN (ET 200S under PROFINET IO), then configure the slots and set their parameters using drag-and-drop with reference to the physical layout.
11	Select <b>Edit &gt; Object properties</b> to assign device names and numbers to the IO devices.

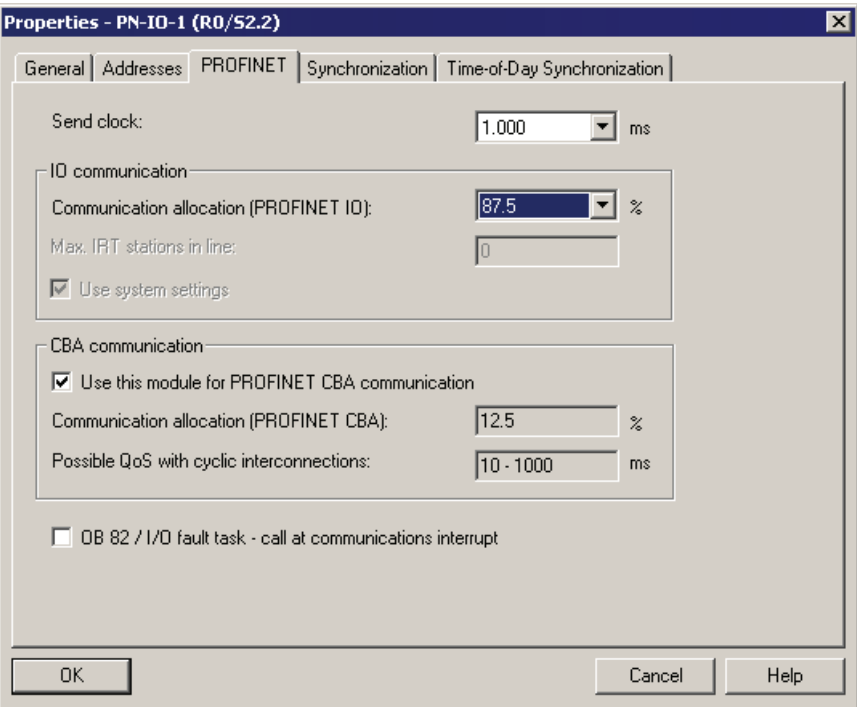
Step	Activity
12	<p>If you are running PROFINET IO and PROFINET CBA in parallel, open the Properties dialog for the PROFINET IO system,</p> <ul style="list-style-type: none"> <li>activating the "Use this module for PROFINET CBA communication" check box</li> <li>Modify the "Communication portion (PROFINET IO)" parameter (e.g. change the communication portion of PROFINET IO to 87.5 %).</li> </ul> 
13	<p>If you wish diagnostic events at the PN interface to trigger a diagnostic interrupt OB (OB 82), then activate the check box "OB 82 / I/O fault task - call in the event of communication interrupt" in the properties of the PROFINET IO system.</p> <p>Tip: The information on the events is also available in the diagnostics buffer of the IM 151-8 PN/DP CPU</p>
14	Save your configuration with <b>Station &gt; Save and compile</b> .
<b>Configuration Download</b>	
15	<p>Download the configuration to the IM 151-8 PN/DP CPU interface module. There are two ways of doing this:</p> <ul style="list-style-type: none"> <li>Online via the PN interface. When you download the configuration in a system containing several nodes, select the appropriate IP address for the IM 151-8 PN/DP CPU interface module. Select the MAC address of the target interface module if the IM 151-8 PN/DP CPU interface module does not yet have an IP address. You can display the list of available nodes in the "Select node address" window whilst downloading the HW configuration. Here you can select the desired target device via the associated IP or MAC address. If the device has only had a MAC address so far, then it can now be assigned the configured IP address.</li> </ul> <p>The programming device must be connected to the subnet. The programming device interface must be set to <b>TCP/IP (Auto)</b>. In the <b>IE-PG Access</b> tab of the interface properties you must set: <b>Assign Project-Specific IP Address</b>.</p> <ul style="list-style-type: none"> <li>offline, by saving the data to a SIMATIC Micro Memory Card in SIMATIC Manager on your programming device, and then inserting the SIMATIC Micro Memory Card into the IM 151-8 PN/DP CPU interface module</li> </ul>

Step	Activity
<b>Assigning IO Device Names</b>	
16	<p><b>Requirement:</b> The programming device must be connected to the subnet. The programming device interface must be set to TCP/IP (Auto) mode. Setting in the <b>IE-PG Access</b> tab of the interface properties dialog box: <b>Assign Project-Specific IP Address.</b></p> <p><b>Procedure:</b> In online mode, select the various IO devices in HW Config, then select <b>PLC &gt; Ethernet &gt; Assign Device Name</b> to assign the corresponding device names.</p> <p><b>Note:</b> When you have configured "Device replacement without removable medium" and specified the set topology of the PROFINET IO system with the topology editor, you don't always have to assign the device name. For this to be the case, the actual topology must correspond with the set topology and the devices must be reset to the factory settings.</p> <p><b>Note:</b> The IM 151-8 PN/DP CPU interface module can only assign the IP address automatically, and thus communicate correctly with the IO device, if you have assigned a device name to the IO device.</p> <p>If the configuration of the IO devices you downloaded to the IM 151-8 PN/DP CPU interface module actually corresponds to their physical configuration on the subnet, then the IO devices will be addressed by the IM 151-8 PN/DP CPU interface module, and the BF LED will stop flashing on both the IM 151-8 PN/DP CPU interface module and the IO device.</p> <p>You can then switch the IM 151-8 PN/DP CPU interface module to RUN, provided there are no other conditions preventing startup, and the IM 151-8 PN/DP CPU interface module and IO devices will exchange data (read inputs, write outputs, for example).</p>

## Result

You have used *STEP 7* to configure the PROFINET interface of your IM 151-8 PN/DP CPU interface module and the PROFINET IO system. The IM 151-8 PN/DP CPU interface module can now be reached by other nodes on your Industrial Ethernet subnet.

## Reference

- Other methods of assigning the IP addresses can be found in the section Assignment of the IP address parameter and the device name (Page 139).
- Detailed information on address assignment for the PROFINET IO interface and for setting the properties of the PROFINET IO interface and the individual ports can be found in the *online Help for STEP 7* and in the PROFINET System Description (<http://support.automation.siemens.com/WW/view/en/19292127>).



### Starting up the IM 151-8 PN/DP CPU interface module as an IO controller

During start-up, the IM 151-8 PN/DP CPU checks the preset configuration against the actual configuration

- Of the local I/O,
- the PROFINET IO system and
- (the distributed I/O on the PROFIBUS DP system).

The start-up of the IM 151-8 PN/DP CPU depends on the configuration settings made under the "Start-up" tab:

Table 8- 12 Starting up the IM151-8 PN/DP CPU interface module as an IO controller

Preset = Actual configuration	Preset ≠ Actual configuration	
	Startup permitted if Preset configuration is not the same as the Actual configuration	Startup not permitted if Preset configuration is not the same as the Actual configuration
IM 151-8 PN/DP CPU in RUN	<p>IM 151-8 PN/DP CPU in RUN After POWER ON, and after the parameter monitoring time has elapsed, the IM 151-8 PN/DP CPU interface module switches to RUN.</p> <p>The flashing BF-PN LED indicates that at least one IO device cannot be addressed. In this case, check that all IO devices are switched on and correspond to the set configuration. For additional information, read the diagnostics buffer in <i>STEP 7</i>.</p>	IM 151-8 PN/DP CPU does not start up.

**Starting up the IM151-8 PN/DP CPU interface module as an I device**

During start-up, the IM 151-8 PN/DP CPU checks the preset configuration against the actual configuration

- of the centralized I/O,
- of the distributed I/O on the PROFIBUS DP system, and
- the PROFINET IO system.

The start-up of the IM 151-8 PN/DP CPU depends on the configuration settings made under the "Start-up" tab:

Table 8- 13 Starting up the IM151-8 PN/DP CPU as an I device

Preset = Actual configuration	Preset ≠ Actual configuration	
	Startup permitted if Preset configuration is not the same as the Actual configuration	Startup not permitted if Preset configuration is not the same as the Actual configuration
IM 151-8 PN/DP CPU in RUN.	<p>IM 151-8 PN/DP CPU in RUN                      After POWER ON, and after the parameter monitoring time has elapsed, the IM 151-8 PN/DP CPU switches to RUN.                      If the LED BF-PN flashes, this means that:</p> <ul style="list-style-type: none"> <li>• When configured as an I device with no lower-level IO system: None of the higher-level controllers can accommodate the I device (due for instance to a loss of connection or to a mismatch of the transfer areas between the IO controller and I device). In this case, check the configuration and the wiring of the PROFINET IO system.</li> <li>• When configured as an I device with a lower-level IO system: The higher-level controller cannot accommodate the I device (due for instance to a loss of connection or to a mismatch of the transfer areas between the IO controller and I device). Or: At least one IO device cannot be assigned an address. In this case, check that all IO devices are switched on and correspond to the set configuration.</li> </ul> <p>For further information, read the diagnostics buffer in STEP 7.</p>	IM 151-8 PN/DP CPU does not start up.

## Detecting interruptions in the data transfer to the IO device

The following table shows how the IM 151-8 PN/DP CPU interface module recognizes interruptions in the data transfer:

Table 8- 14 Event recognition of the IM 151-8 PN/DP CPU interface module as an IO controller

Event	What happens in the IO controller?	
	IM 151-8 PN/DP CPU in RUN	IM 151-8 PN/DP CPU in STOP
Bus interruption (short circuit, connector removed)	<ul style="list-style-type: none"> <li>• Call to OB 86 with the message <b>Station failure</b> (incoming event; diagnostics address of the IO device)</li> <li>• With I/O access: call of OB 122 (I/O access error)</li> </ul>	The event is written to the diagnostics buffer

Further information on this and the behavior during status transitions in the IO controller or in the I device can be found in the section "I device" of the PROFINET System Description (<http://support.automation.siemens.com/WW/view/en/19292127>).

### Note

When commissioning the IM151-8 PN/DP CPU for the operation of I devices, both in the IO controller and in the I device, always program the OB 83 (because of the Return-of-Submodule-Alarms which are generated during status transition of the respective communications partner in the RUN mode).

Always program OB86 when you commission the CPU. This allows you to detect and analyze interruptions in the data transfer.

If "OB85 call during I/O Access Error" was also configured in the HW config, the OB 85 must also be programmed so as to detect access errors during the process image transfer.

## Reference

A detailed description of the user data transfer can be found in the PROFINET System Description (<http://support.automation.siemens.com/WW/view/en/19292127>).

## Status/control, programming via PROFINET

You can use the PROFINET interface to program the IM 151-8 PN/DP CPU interface module or execute the status and control programming device functions.

If you have not yet commissioned the PROFINET interface of the IM 151-8 PN/DP CPU interface module, you can connect to the IM 151-8 PN/DP CPU interface module using its MAC address (see also *Configuring the PROFINET IO System* in the table above).

Therefore, always download the configuration data from the HW Config to the IM 151-8 PN/DP CPU interface module. You select the IM 151-8 PN/DP CPU interface module from the MAC address. After you have downloaded the configuration, the IM 151-8 PN/DP CPU interface module is also assigned the configured IP address. With that you can then use all programming device functions, such as download program, status/control etc., on the interface.



## Service and maintenance

### 9.1 Overview

For the ET 200S with IM 151-8 PN/DP CPU, service and maintenance are

- Backing up the firmware to the SIMATIC Micro Memory Card
- Updating the firmware via the SIMATIC Micro Memory Card
- Updating of the firmware online
- Backing up of project data on a SIMATIC Micro Memory Card
- Replacing an IM 151-8 PN/DP CPU interface module
- replacing a DP master module

### 9.2 Backing up firmware on a SIMATIC Micro Memory Card

#### In which situations should I back up the firmware?

In some cases, we recommend that you back up the firmware on your IM 151-8 PN/DP CPU interface module.

For example, you might want to replace the IM 151-8 PN/DP CPU interface module in your system with an IM 151-8 PN/DP CPU interface module from your inventory. In this case, you should make sure that the IM 151-8 PN/DP CPU interface module from your inventory has the same firmware that is used in the system.

We also recommend that you create a back-up copy of the firmware for emergency situations.

#### On which IM 151-8 PN/DP CPU can you backup the firmware?

You can backup firmware as of the following versions of the IM 151-8 PN/DP CPU interface module:

Interface module	Order number	SIMATIC Micro Memory Card required ≥ in MB
IM 151-8 PN/DP CPU	6ES7151-8AB00-0AB0	4
IM151-8 PN/DP CPU	6ES7151-8AB01-0AB0	8

## Backing up the firmware on your IM 151-8 PN/DP CPU interface module to the SIMATIC Micro Memory Card

Table 9- 1 Backing up the firmware to the SIMATIC micro memory card

Step	Action required:	This takes place in the IM 151-8 PN/DP CPU interface module:
1.	Insert the new SIMATIC Micro Memory Card in the IM 151-8 PN/DP CPU interface module.	The IM 151-8 PN/DP CPU requests a memory reset.
2.	Turn the mode selector switch to MRES position and hold it there.	-
3.	Switch supply voltage off and then on again and hold the mode selector switch in the MRES position until ...	... the STOP, RUN and FRCE LEDs start flashing.
4.	Mode selector switch to STOP.	-
5.	Mode selector switch briefly to MRES position, then let it return to STOP.	<ul style="list-style-type: none"> <li>The IM 151-8 PN/DP CPU interface module starts to back up the firmware on the SIMATIC Micro Memory Card.</li> <li>All LEDs are lit during the backup operation.</li> <li>The STOP LED flashes when the backup is complete, to indicate that the IM 151-8 PN/DP CPU interface module requires a memory reset.</li> </ul>
6.	Remove the SIMATIC Micro Memory Card with the backed up firmware.	-

## 9.3 Updating the firmware

### 9.3.1 When should you update the IM 151-8 PN/DP CPU interface module?

After (compatible) functional expansions, or after an enhancement of operating system performance, the firmware of the IM 151-8 PN/DP CPU interface module should be upgraded (updated) to the latest version.

#### Update of an IM 151-8 PN/DP CPU

The IM151-8 PN/DP CPU with the order number 6ES7151-8AB00-0AB0 cannot currently be upgraded to a firmware version  $\geq$  V3.2.

An IM151-8 PN/DP CPU with the order number 6ES7151-8AB01-0AB0 can be configured as IM151-6ES7151-8AB00-0AB0 using STEP 7 V5.4. The new functionalities of the IM151-8 PN/DP CPU V3.2 are, however, not available.

### Where do I get the latest version of the firmware?

You can order the latest firmware (as \*.UPD files) from your Siemens partner, or download it from the Internet (<http://www.siemens.com/automation/service&support>).

### 9.3.2 Firmware update using a SIMATIC Micro Memory Card

Table 9- 2 Firmware update using a SIMATIC Micro Memory Card

Step	Action required:	This takes place in the IM 151-8 PN/DP CPU interface module:
1	<p><b>Recommendation</b></p> <p>Before you update the IM 151-8 PN/DP CPU interface module firmware, create a backup copy of the "old" firmware on an empty SIMATIC Micro Memory Card. If problems occur during the update, you can reload your old firmware from the SIMATIC Micro Memory Card.</p>	
2	<p>Transfer the update files to a blank SIMATIC Micro Memory Card using <i>STEP 7</i> and your programming device. To do this, click "Update PLC / operating system" in the SIMATIC Manager.</p> <p>Note: You will need a SIMATIC Micro Memory Card with at least 8 MB of memory.</p>	-
3	<p>Switch off the IM 151-8 PN/DP CPU power and insert a SIMATIC Micro Memory Card containing the firmware update.</p>	-
4	<p>Switch on power.</p>	<ul style="list-style-type: none"> <li>• The IM 151-8 PN/DP CPU interface module automatically detects the SIMATIC Micro Memory Card with the firmware update and runs the update.</li> <li>• All LEDs are lit during firmware update.</li> <li>• The STOP LED flashes when the backup is complete, to indicate that the IM 151-8 PN/DP CPU interface module requires a memory reset.</li> </ul>
5	<p>Switch off the IM 151-8 PN/DP CPU power and insert a SIMATIC Micro Memory Card containing the firmware update.</p>	-

**Result**

- You have updated your IM 151-8 PN/DP CPU interface module online with a new firmware version.
- All the parameters within the module have been reset during the firmware update.

<b>NOTICE</b>
---------------

Aborting the firmware update by POWER ON / POWER OFF or by removal of the Micro Memory Card can lead to loss of the firmware on the CPU. In this condition only the SF-LED continues to flash at 2 Hz (all other LEDs are off). However since the boot block remains, you can regenerate the valid firmware by repeating the firmware update as described.
------------------------------------------------------------------------------------------------------------------------------------------------------------------------------------------------------------------------------------------------------------------------------------------------------------------------------------------------------------



### 9.3.3 Updating the firmware online (via networks)

To update the IM 151-8 PN/DP CPU interface module firmware, you require the (\*.UPD) files containing the latest FW version.

#### Requirements

- The firmware can be updated online in *STEP 7*V5.4 + SP 4 or later.
- The interface module of the station pending a firmware update must be accessible online.
- The files containing the current firmware versions must be available in the file system of your programming device or PC. A folder may contain only the files of one firmware version.

#### Performing a firmware update

1. Run *STEP 7* and change to HW Config.
2. Open the station with the IM 151-8 PN/DP CPU interface module that is to be updated.
3. Select the IM 151-8 PN/DP CPU interface module.
4. Select **PLC > Update Firmware**.
5. In the **Update Firmware** dialog, select the path to the firmware update files (\*.UPD) using the **Browse** button.
6. After you selected a file, the information in the lower fields of the **Update Firmware** dialog box shows you the firmware file and version for the corresponding modules.
7. Click on the **Run** button. *STEP 7* checks to determine whether the selected file can be interpreted by the IM 151-8 PN/DP CPU interface module and, if so, then downloads the file to the interface module. If this requires changing the operating state of the IM 151-8 PN/DP CPU interface module, you will be asked to perform these tasks in the relevant dialog boxes. The IM 151-8 PN/DP CPU interface module then performs the firmware update independently.
8. Use *STEP 7* (read out the CPU diagnostics buffer) to verify that the IM 151-8 PN/DP CPU interface module can start with the new firmware.

As an alternative you can also trigger the firmware update in SIMATIC Manager:

- Select the respective IM 151-8 PN/DP CPU interface module as the target CPU and then select "Update PLC / Firmware".
- Via "Available nodes", select the target CPU and then select "Update PLC / Firmware".

You can use both paths to read step 5 described above. Then continue with the remaining steps.

#### Result

- You have updated your IM 151-8 PN/DP CPU interface module online with a new firmware version.

## 9.4 Backing up project data on a SIMATIC Micro Memory Card

### Function principle

Using the **Save project to Memory Card** and **Fetch project from Memory Card** functions, you can save all project data to a SIMATIC Micro Memory Card, and retrieve these at a later time. For this operation, the SIMATIC Micro Memory Card can be located in an IM 151-8 PN/DP CPU interface module or in the SIMATIC Micro Memory Card adapter of a programming device or PC.

Project data is compressed before it is saved to a SIMATIC Micro Memory Card, and uncompressed on retrieval.

---

#### Note

In addition to project data, you may also have to store your user data on the SIMATIC Micro Memory Card. You should therefore first select a SIMATIC Micro Memory Card with sufficient free memory.

A message warns you if the memory capacity on your SIMATIC Micro Memory Card is insufficient

---

The volume of project data to be saved corresponds with the size of the project's archive file.

---

#### Note

For technical reasons, you can only transfer the entire contents (user program and project data) using the **Save project to memory card** action.

---

## Handling the functions

How you use the **Save project to memory card / Retrieve project from memory card** functions depends on the location of the SIMATIC micro memory card:

- When the SIMATIC MMC is inserted in the MMC slot, select a project level (for example, CPU, programs, sources or blocks) which is uniquely assigned to the IM 151-8 PN/DP CPU interface module from the project window in SIMATIC Manager. Select the **Target system > Save project to memory card** or **Target system > Retrieve project from memory card** menu command. All the complete project data is then written to / retrieved from the SIMATIC Micro Memory Card.
- If project data are not available on the currently used programming device (PG/PC), you can select the source CPU via "Available nodes" window. Select **PLC > Show available nodes** to open the "Available nodes" window. Then select the connection / IM 151-8 PN/DP CPU that contains your project data on the SIMATIC Micro Memory Card. Now select menu command **Fetch project from Memory Card**.
- If the SIMATIC MMC is located in the MMC programming unit of a PD or PC, open the "S7 memory card window" using the **File > S7 Memory Card > Open command**. Select the **Target system > Save project to memory card** or **Target system > Retrieve project from memory card** menu command. to open a dialog in which you can select the source or target project.

---

### Note

Project data can generate high data traffic. Especially in RUN mode with read/write access to the IM 151-8 PN/DP CPU interface module, this can lead to waiting periods of several minutes.

---

## Sample application

When you assign more than one member of your service and maintenance department to perform maintenance tasks on a SIMATIC PLC, it may prove difficult to provide quick access to current configuration data to each staff member.

However, IM 151-8 PN/DP CPU interface module configuration data available locally on any IM 151-8 PN/DP CPU that is to be serviced can be accessed by any member of the service department. They can edit this data and then release the updated version to all other personnel.

## 9.5 Replacing the IM 151-8 PN/DP CPU interface module

### Introduction

---

**Note**

If you remove an (operational) device and re-use it in another place or place it in storage, the device should be restored to its as-delivered condition, since the IP address of the device will generally be stored retentively.

---

You can replace the IM 151-8 PN/DP CPU interface module if it is faulty.

### Requirements

To replace the IM 151-8 PN/DP CPU interface module you must switch off the supply voltage on the faulty IM 151-8 PN/DP CPU interface module .

Result: Failure of the ET 200S station and all components connected to it (DP slaves, IO devices)

<b>CAUTION</b>
----------------

<b>PROFINET IO</b>
--------------------

If you switch off the supply voltage at an ET 200S, the integrated switch will also fail. This will interrupt communication with all connected peers (e.g. IO devices or other PROFINET devices) that communicate with one another via this switch.
-----------------------------------------------------------------------------------------------------------------------------------------------------------------------------------------------------------------------------------------------------

<b>NOTICE</b>
---------------

<b>PROFIBUS DP</b>
--------------------

The bus terminator function may fail if you shut down supply voltage at the first or last bus node of a bus segment.
----------------------------------------------------------------------------------------------------------------------

### Required tools

Screwdriver with 3 mm blade

## Replacing the IM 151-8 PN/DP CPU interface module

The IM 151-8 PN/DP CPU interface module is wired, and the terminal modules are on the right:

1. Switch off the supply voltage for the faulty IM 151-8 PN/DP CPU interface module.
2. Remove the SIMATIC Micro Memory Card from the receptacle (see Inserting/replacing a Micro Memory Card (Page 148))
3. Release the connector for the supply voltage and the RJ45 connector(s) on the IM 151-8 PN/DP CPU interface module.
4. Use a screwdriver to slide the slider on the IM 151-8 PN/DP CPU interface module downwards until it stops. Now move the IM 151-8 PN/DP CPU interface module to the left.

Note: The slider is located in the centre beneath the IM 151-8 PN/DP CPU interface module.

5. Press down on the slider while swiveling the IM 151-8 PN/DP CPU interface module off the rail.
6. Suspend the new IM 151-8 PN/DP CPU interface module in the rail.
7. Press down on the slider while swiveling the IM 151-8 PN/DP CPU interface module downwards until the slider audibly engages.
8. Now move the IM 151-8 PN/DP CPU interface module to the right until the first terminal module.

If a DP master module is connected:

Move the IM 151-8 PN/DP CPU interface module to the right until it audibly engages on the DP master module.

9. Insert the SIMATIC Micro Memory Card removed from the defective IM 151-8 PN/DP CPU interface module into the slot on the new IM 151-8 PN/DP CPU interface module.
10. Switch on the power supply.

## Behavior of the IM 151-8 PN/DP CPU interface module after replacement

As the SIMATIC Micro Memory Card has been changed, after the IM 151-8 PN/DP CPU interface module has been replaced it always automatically resets the memory and remains in STOP mode, regardless of the position of the mode selector. The IM 151-8 PN/DP CPU interface module can then be switched to RUN once more using the mode selector.

If the IM 151-8 PN/DP CPU interface module stays in STOP, you can view the cause of error in *STEP 7* (see the *STEP 7* User Manual).

## 9.6 Replacing the DP master module

### Introduction

You may replace a defective DP master module.

### Requirements

To replace the DP master module you must switch off the supply voltage on the associated IM 151-8 PN/DP CPU interface module .

Result: Failure of the ET 200S station and all components connected to it (DP slaves, IO devices)

<b>CAUTION</b>
----------------

<b>PROFINET IO</b>
--------------------

If you switch off the supply voltage at an ET 200S, the integrated switch will also fail. This will interrupt communication with all connected partners (e.g. IO devices or other PROFINET devices) that communicate with one another via this switch.
--------------------------------------------------------------------------------------------------------------------------------------------------------------------------------------------------------------------------------------------------------

<b>NOTICE</b>
---------------

<b>PROFIBUS DP</b>
--------------------

The bus terminator function may fail if you shut down supply voltage at the first or last bus node of a bus segment.
----------------------------------------------------------------------------------------------------------------------

### Required tools

3 mm screwdriver

## Replacing the DP master module

The DP master module and the IM 151-8 PN/DP CPU interface module are wired, and the terminal modules are on the right:

1. Switch off the supply voltage for the respective ET 200S station (IM 151-8 PN/DP CPU).
2. Release the connector for the supply voltage and the RJ45 connector(s) on the IM 151-8 PN/DP CPU interface module.
3. Use a screwdriver to slide the slider on the IM 151-8 PN/DP CPU interface module downwards until it stops. Now move the IM 151-8 PN/DP CPU interface module about 40 mm to the left.

Note: The slider is located in the centre beneath the IM 151-8 PN/DP CPU interface module.

4. Use the screwdriver to slide the slider on the DP master module downwards to the stop. Slide the faulty DP master module to the left until the connector for the backplane bus is free.

Note: The slider is located underneath the DP master module.

5. Keeping the slider pressed down, swivel the DP master module out of the mounting rail.
6. Suspend the new DP master module in the rail and swing it downwards.
7. Slide the DP master module to the right until the first terminal module.
8. Move the IM 151-8 PN/DP CPU interface module to the right until it audibly engages with the DP master module.
9. If required, connect the connector for the supply voltage and the RJ45 connector(s) with the IM 151-8 PN/DP CPU interface module.
10. Switch on the power supply.





## 10.1 Assigning parameters of the reference junction for the connection of thermocouples

### Introduction

If you want to use the IM 151-8 PN/DP CPU interface module in an ET 200S system with thermocouples and a reference junction, set the parameters in the "Properties" section of the hardware configuration.

### Parameter assignment of the reference junction

Table 10- 1 Setting parameters for the reference junction

Parameters	Value range	Explanation
Activation of the reference junction	activated / not activated (Example, see figure below)	You can enable the reference junction with this parameter. Only then can you continue to parameterize the reference junction.
Slot	none / 5 to 66 (Example, see figure below)	You can use this parameter to assign the RTD module slot to the reference junction.
Channel number	RTD on channel 0 RTD on channel 1 (Example, see figure below)	This parameter can be used to set the channel (0 / 1) for measuring the reference temperature (calculation of the compensation value) for the assigned slot of the RTD module.

RTD module parameter	Value range	Explanation
Measurement type/measurement range	Resistance / temperature measurement, e.g. <ul style="list-style-type: none"> <li>RTD-4L Pt100 standard range</li> </ul>	If you use a channel of the RTD module for reference junction configuration, you must configure the measurement type / measurement range for this channel as <b>RTD-4L Pt 100 climatic range</b> .

TC module parameter	Value range	Explanation
Reference junction number	1	This parameter allows you to assign the reference junction (1) that contains the reference temperature (compensation value).
Reference junction channel 0 and reference junction channel 1	None, RTD	This parameter allows you to enable the use of the reference junction.

Example of a parameterization dialog box

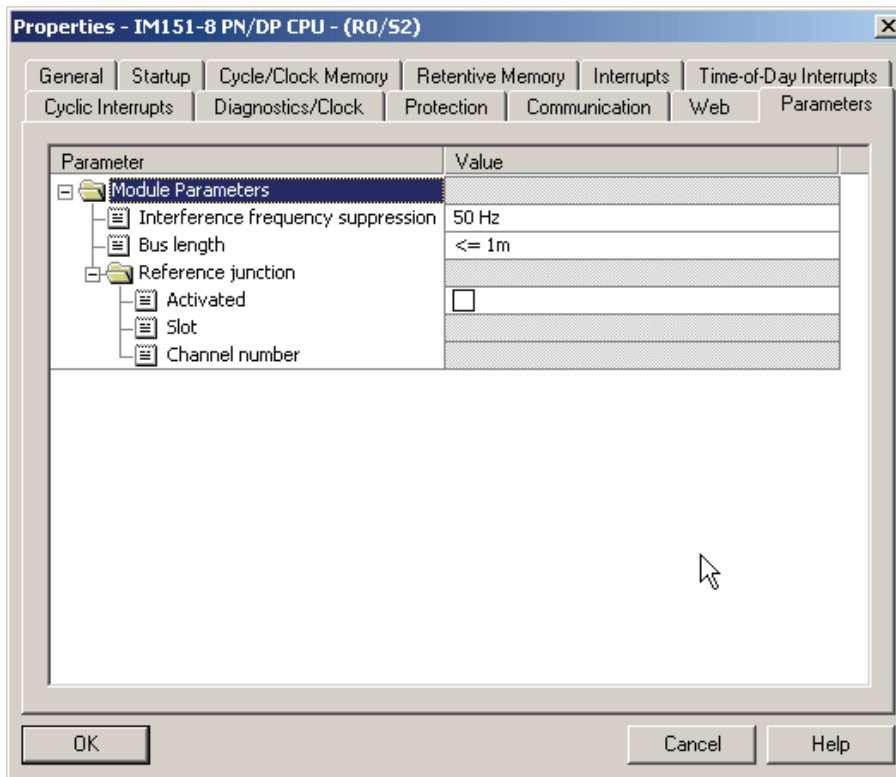

Figure 10-1 Example for a parameterization dialog box of the IM 151-8 PN/DP CPU module parameters in STEP 7

Reference

You can find detailed information on the procedure, the connection system and an example of configuration in the section entitled *Analog Electronic Modules* in the *ET 200S Distributed I/O System Manual*.

## 10.2 Removal and insertion of modules during operation

### 10.2.1 Overview

The ET 200S with IM 151-8 PN/DP CPU supports the removal and insertion of in each case one module of the ET 200S I/O system during operation and in an energized state.

#### Exceptions

The IM 151-8 PN/DP CPU interface module itself must **not** be removed during operation and in an energized state.

#### Removal and insertion of modules in an energized state and during operation

When removing and inserting modules in an energized state and during operation, refer both to the specifications given here and the restrictions in the ET 200S Distributed I/O System (<http://support.automation.siemens.com/WW/view/en/1144348>) Operating Instructions, section *Wiring and equipping*.

#### WARNING

When an output module is inserted, the outputs set by the user program become active immediately. We therefore advise you to set the outputs to "0" in the user program before removing the module.

If modules are removed or inserted incorrectly (see ET 200S Distributed I/O System (<http://support.automation.siemens.com/WW/view/en/1144348>) Operating Instructions, section *Wiring and equipping*), this can cause uncontrolled system states. Adjacent modules could be affected.

#### Special considerations when using I/O transfer areas

Information on the behavior within the IO controller and the I device during processing, diagnostics, insert/remove module interrupts and load voltage diagnostics of modules, that are configured in the I/O transfer area of an I device, can be found in the PROFINET System Description (<http://support.automation.siemens.com/WW/view/en/19292127>), section *Diagnostics and interrupt behavior* and *Conditions for use of I devices*.

### 10.2.2 What happens when modules are removed during operation

- When you remove a module from the ET 200S I/O system during operation, OB 83 is called and a corresponding diagnostics buffer entry is generated (event ID 3961H). This takes place regardless of whether the associated power module is switched on or off.  
If the OB 83 is available on the IM 151-8 PN/DP CPU interface module, this remains in RUN.  
The absence of the module is noted in the system status list.
- If the module that has been removed is accessed from the user program, an I/O access error occurs with a corresponding entry in the diagnostics buffer and the OB 122 is called up.  
If the OB 122 is available on the IM 151-8 PN/DP CPU interface module, this remains in RUN.

### 10.2.3 Procedure when modules are inserted during operation

#### Overview

If you insert a module in the ET 200S I/O system during operation, the IM 151-8 PN/DP CPU interface module initially carries out a set / actual comparison with regard to the inserted module. In doing so, the configured module is compared with the one that is actually inserted. The activities described below take place dependent on the result of the set / actual comparison.

#### Non-configurable modules

The following actions will take place regardless of whether the power module of the inserted module is switched on or off.

Table 10- 2 Result of the set / actual comparison in the case of non-configurable modules

Inserted module = configured module	Inserted module ≠ configured module
OB 83 is called with the corresponding diagnostics buffer entry (event -ID 3861H).	OB 83 is called with the corresponding diagnostics buffer entry (event -ID 3863H).
The module remains entered in the system status list as unavailable.	The module remains entered in the system status list as unavailable.
Direct access is again possible.	Direct access is not possible.

**Modules that can be parameterized**

The following actions only take place when the power module of the inserted module is switched **on**.

Table 10- 3 Result of the preset/actual comparison in the case of parameterizable modules with the power module switched on

Inserted module = configured module	Inserted module ≠ configured module
OB 83 is called with the corresponding diagnostics buffer entry (event -ID 3861 <sub>H</sub> ).	OB 83 is called with the corresponding diagnostics buffer entry (event ID 3863 <sub>H</sub> ).
The IM 151-8 PN/DP CPU interface module reconfigures the module.	The IM 151-8 PN/DP CPU interface module does not configure the module.
If parameter assignment is successful, the module is entered in the system status list as available.	The module remains entered in the system status list as unavailable. The SF LED on the module remains lit.
Direct access is again possible.	Direct access is not possible.

The following actions only take place when the power module of the inserted module is switched **off**.

Table 10- 4 Result of the preset/actual comparison in the case of parameterizable modules with the power module switched off

Inserted module = configured module	Inserted module ≠ configured module
OB 83 is called with the corresponding diagnostics buffer entry (event -ID 3861 <sub>H</sub> ).	OB 83 is called with the corresponding diagnostics buffer entry (event ID 3863 <sub>H</sub> ).
When the power module is switched on, the IM 151-8 PN/DP CPU interface module reconfigures the module.	When the power module is switched on, the IM 151-8 PN/DP CPU interface module does not reconfigure the module.
If parameter assignment is successful, the module is entered in the system status list as available.	The module remains entered in the system status list as unavailable. The SF LED on the module remains lit.
Direct access is again possible.	Direct access is not possible.

## 10.3 Switching power modules off and on during operation

### What happens when power modules are switched off during operation

If the load power voltage to a power module is switched off during operation, the following activities take place:

- If you enable diagnostics when assigning parameters for the power module, the diagnostics interrupt OB 82 (diagnostics address of the power module) is called with the corresponding diagnostics buffer entry (event ID 3942<sub>H</sub>).
- The power module is entered as present but faulty in the system status list.

Switching off the load power supply has the following effects on the modules supplied by the power module:

- The SF LED on the modules lights up.
- The modules can continue to be accessed without an I/O access error occurring.
- The outputs of the modules are deenergized and inactive for the process.
- The inputs of digital modules and FM modules return 0; the inputs of analog modules return 7FFF<sub>H</sub>.

### What happens when power modules are switched on during operation

If the load power supply to a power module is switched on during operation, the following activities take place:

- If you enable diagnostics when assigning parameters for the power module, the diagnostics interrupt OB 82 (diagnostics address of the power module) is called with the corresponding diagnostics buffer entry (event ID 3842<sub>H</sub>).
- The power module is entered as present and o.k. in the system status list.

Switching on the load power supply has the following effects on modules supplied by the power module:

- The SF LED on the modules goes out.
- The modules regain their full functionality.

### Removal and insertion of power modules during operation

If, during operation, you remove or insert a power module, the activities listed in section *Removing and inserting modules during operation* take place.

Removal and insertion has the same effects as switching the load power supply off and on for the modules that are supplied by the power module.

### Special considerations when using I/O transfer areas

Information on the behavior within the IO controller and the I device during processing, diagnostics, insert/remove module interrupts and load voltage diagnostics of modules, that are configured in the I/O transfer area of an I device can be found in the PROFINET System Description (<http://support.automation.siemens.com/WW/view/en/19292127>), section *Diagnostics and interrupt behavior* and *Conditions for use of I devices*.

## 10.4 Power module with status byte

### Diagnostic status of the power module

The diagnostic status of the power module can be evaluated as the input byte in the status byte.

To do this, set a check in the "Status byte" check box in the "Addresses" tab in the properties dialog of the power module.

The current status of the power module is held in a freely selectable input byte of the status byte. This is updated irrespective of whether the "No Load Voltage" diagnosis has been enabled.

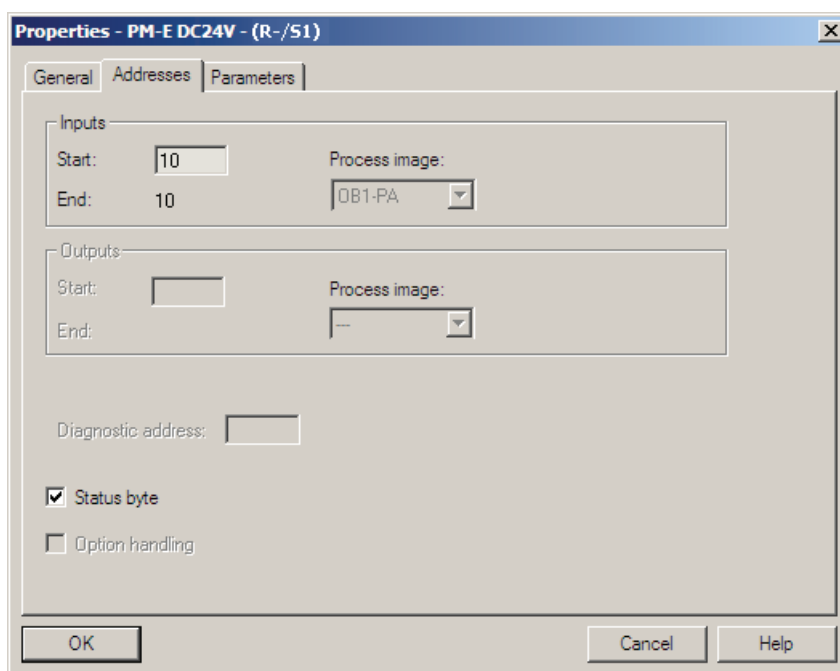

### Example: Cross circuit detection

An external power supply can cause a cross circuit in a power module, even when it is switched off. The status byte allows detection of the cross circuit.

### Additional information

Information on the meaning of bits in the status byte can be found in the documentation for the respective power module.





# Debugging functions, diagnostics and troubleshooting

# 11

## 11.1 Overview

This chapter helps you to get acquainted with tools you can use to carry out the following tasks:

- Hardware/software error diagnostics.
- Elimination of hardware/software errors.
- Testing the hardware/software – for example, during commissioning.

---

### Note

It would go beyond the scope of this manual to provide detailed descriptions of all the tools you can use for diagnostics, testing and troubleshooting functions. Further notes are found in the relevant hardware/software manuals.

---

## 11.2 Reading/saving service data

### Application

In the case of a service, for example, if the IM151-8 PN/DP CPU signals the state "DEFECTIVE" (all LEDs flashing), you have the option of saving special information for analyzing the CPU state.

This information is stored in the diagnostic buffer and in the actual service data.

Select the "Target system -> Save service data" command to read and this information and save the data to a file to forward to Customer Support.

### Procedure

1. If the IM151-8 PN/DP CPU is in the state "DEFECTIVE" (all LEDs flashing), switch the power supply off and on (power off/on).  
Result: The IM 151-8 PN/DP CPU is in "STOP" mode.
2. As soon as possible after the IM151-8 PN/DP CPU has switched to "STOP" mode, select the respective IM151-8 PN/DP CPU with the "Target system > Available nodes" menu command in the SIMATIC Manager.
3. Use the SIMATIC Manager menu command "Target system > Save service data" to save the service data.  
Result: A dialog box opens in which you specify the storage location and name of the two files.
4. Save the files.
5. Forward these files to Customer Support on request.

## 11.3 Identification and maintenance data of the IM 151-8 PN/DP CPU interface module

### Definition and properties

Identification and maintenance data (I&M) are data that are stored in a module for assisting you in:

- Checking the system configuration
- Locating hardware changes in a system
- Correcting errors in a system

Identification data (I data) is information regarding the module, like for example, order number and serial number, which are partly also printed on the housing of the module. I data is manufacturer's information about the module. It is fixed and can only be read.

Maintenance data (M data) is system-specific information, such as the installation location. M data is created during the configuration and written to the module.

I&M data enable modules to be uniquely identified online.

### Reading and writing the I&M data of the IM 151-8 PN/DP CPU interface module with *STEP 7*

#### Read:

- In *STEP 7* the I&M data is displayed under "Module state – IM 151-8 PN/DP CPU" ("General" and "Identification" tabs) and via "Available nodes" (detailed view) (see *STEP 7* online help).
- In the user program, the I&M data can be read via SFC 51. Specify the required SSL sublist number and the index in the input parameters of the SFC 51 (see table below).
- You can read the I&M data on the "Start" and "Identification" pages using the web server.

#### Write:

You will always need *STEP 7* HW Config to write the M data for modules.

For example, you can enter the following data during configuration:

- Name of the automation system (device name)  
The device name is assigned when you create the station in SIMATIC Manager. In this case a "SIMATIC 300(1) station is created by default. This name can be changed at any time.
- You can enter the following data in *STEP 7* HW Config on the "General" tab under "IM 151-8 PN/DP CPU Properties":
  - Name of the module  
In this case, HW Config assigns a default name, e.g. IM 151-8 PN/DP CPU interface module (this can be changed).
  - Higher level designation of the module  
No default setting
  - Location designation of a module  
No default setting

### Reading the I&M data from the IM 151-8 PN/DP CPU interface module with the user program

If you want to read the I&M data from the IM 151-8 PN/DP CPU interface module in the user program, you must read the associated system state list, specifying the relevant SSL ID and the index using SFC 51. The SSL IDs and the associated indexes are listed in the following table.

### SSL sublists with I&M data

The I&M data can be found in the following SSL sublists under the specified indexes.

Table 11- 1 SSL sublists with I&M data

SSL ID W#16#...	Index W#16#...	Meaning
<b>Module identification</b>		
0111		an identification data record
	0001	Identification of the module This contains the module's order number and the product version.
	0006	Identification of the basic software Provides information on the software version of the module. (The IM 151-8 PN/DP CPU interface module has no basic software so, in this case, the identification data are the same as index 0001.)
	0007	Identification of the basic firmware Provides information on the firmware version of the module.
<b>Identification of a component</b>		
011C		Identification of a component
	0001	Name of the automation system The name of the automation system (device name) is saved to this parameter.
	0002	Name of the module The name of the module is saved to this parameter.
	0003	Higher level designation of the module This is a system-wide unique identifier for the module.
	000B	Location designation of a module This is the module's installation location.

For detailed information on the structure and content of the system state lists, see the *System and Standard Functions for S7-300/400* reference manual.

Additional information about reading the SSL with SFC 51 can be found in Reference Manual *System and Standard Functions for S7-300/400* or in the *Online Help for STEP 7*.

### I&M data for the connected I/O devices

Information about the I&M data for the I/O devices connected to the IM 151-8 PN/DP CPU interface module can be found in the relevant I/O module manuals.

## 11.4 Debugging functions

### 11.4.1 Overview: Debugging functions

#### Determining addressed nodes with "Node flashing test"

To identify the addressed node, select **PLC > Diagnostics/Setting > Node/Flashing Test** in *STEP 7*.

A dialog appears in which you can set the flashing time and start the flashing test. The directly connected node can be identified by a flashing FRCE LED. The flashing test cannot be performed if the FORCE function is active.

#### Debugging functions of the software: Monitoring and modifying variables, stepping mode

*STEP 7* offers you the following testing functions that you can also use for diagnostics:

- Monitoring and modifying variables

Can be used to monitor the current values of individual variables of a user program or an IM 151-8 PN/DP CPU interface module on the programming device / PC. You can also assign constant values to the variables.

- Testing with program status

You can test your program by viewing the program status of each function (result of logical links, status bit) or the data of specific registers in real-time mode.

If you have selected the LAD programming language to be represented in *STEP 7*, the color of the symbol will indicate a closed switch or an active circuit, for example.

- Stepping mode

When testing in single-step mode, you can process your program instructions in sequence (= single-step) and set break points. This is only possible in testing mode and not in process mode.

---

#### Note

##### Number of blocks and breakpoints that can be monitored with status block

In the case of IM151-8 PN/DP CPU  $\geq$  V3.2, you can monitor two blocks at the same time and can set up to four breakpoints in single-step mode.

---

### Debugging functions of the software: Forcing variables

The Force function can be used to assign the variables of a user program or IM 151-8 PN/DP CPU interface module (also: inputs and outputs) constant values which can not be overwritten by the user program.

For example, you can use it to jumper sensors or switch outputs permanently, irrespective of the user program.

**! DANGER**

This could result in severe injury or even death, and damage to property. Incorrect use of the Force function could result in death or severe injury, and damage to machinery or even the entire plant. Always follow the safety instructions in the *STEP 7 manuals*.

**! DANGER**

**Forcing with the IM 151-8 PN/DP CPU interface module**

The force values in the process image of the **inputs** can be overwritten by write commands (such as T IB x, = I x.y, Copy with SFC, etc.) and by read I/O commands (such as L PIW x) in the user program, or by write PG/OP functions! **Outputs** initialized with forced values only return the forced value if not accessed by the user program via I/O write instructions (TPQB x, for example) or by programming device / OP write functions!  
 Always ensure that forced values in the I/O process image cannot be overwritten by the user program or programming device / OP functions!

In the case of the IM 151-8 PN/DP CPU interface module, forcing corresponds to a "cyclic control"

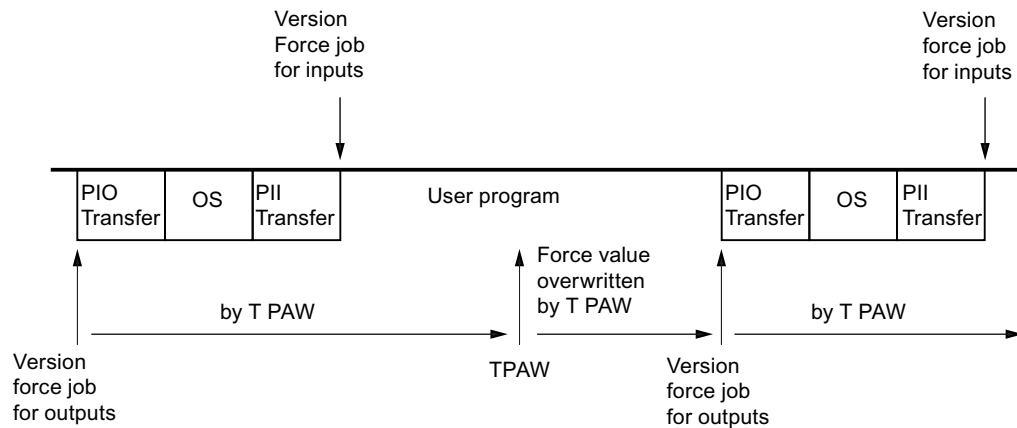

OS: Operating system processing

Figure 11-1 Forcing with the IM 151-8 PN/DP CPU interface module

**Note**

**Forcing process image partitions**

Inputs and outputs within the process image partition cannot be forced.

**The differences between forcing and modifying variables**

Table 11-2 The differences between forcing and modifying variables

Characteristics/function	Forcing	Modifying Variables
Memory bit (M)	-	Yes
Timers and counters (T, C)	-	Yes
Data blocks (DB)	-	Yes
Inputs and outputs (I, O)	Yes	Yes
Peripheral inputs (PI)	-	-
Peripheral outputs (PO)	-	Yes
User program can overwrite modify/force values	Yes	Yes
Maximum number of force values	10	-
POWER OFF retentive	Yes	No

**Reference**

Details on debugging functions of the software are available in the *STEP 7 Online Help* and in the *Programming with STEP 7* (<http://support.automation.siemens.com/WW/view/en/18652056>) manual.

For additional information on the cycle times, please refer to the "Cycle time (Page 247)" chapter.

## 11.4.2 Overview: Diagnostics

### Introduction

System errors can occur especially in the commissioning phase. Tracking these errors might be a time-consuming effort, since they can occur both on the hardware and software side. The many different testing functions ensure that commissioning runs smoothly.

---

#### Note

Errors during **operation** are almost always a result of faults or damage to the hardware.

---

### Type of error

Errors that the IM 151-8 PN/DP CPU interface module can recognize and to which you can respond with organization blocks (OBs) can be split into the following categories:

- Synchronous error: Errors you can relate to a specific point in the user program (error when accessing an I/O module, for example).
- Asynchronous error: Errors you can **not** relate to a specific point in the user program (cycle time exceeded, module error, for example).

### Troubleshooting

Programming with foresight and, above all, knowledge and proper handling of diagnostic tools puts you into an advantageous position in error situations:

- You can reduce the effects of errors.
- It makes it easier for you to locate errors (by programming error OBs, for example).
- You can limit downtimes.

### Diagnostics with LED display

The SIMATIC hardware of the distributed I/Os offers diagnostics with LEDs.

These LEDs are implemented in three colors:

LED color	Status of the IM 151-8 PN/DP CPU interface module
Green	Regular operation. Example: Power is on.
Yellow	Non-regular operating status. Example: Forcing is active.
Red	Fault. Example: Bus error
LED flashing	Special event Example: Memory reset

The LEDs for the PROFINET interface ports are of the following colors:

LED color	State	Meaning
Green	Off	No other device is connected to the corresponding port of the integrated PROFINET interface of the IM 151-8 PN/DP CPU interface module .
	On	Another PROFINET device (such as a switch) is connected at the corresponding port of the integrated PROFINET interface of the IM 151-8 PN/DP CPU interface module and the physical connection has been established.

### Reference

Notes on diagnosing suitable I/O modules can be found in the *ET 200S* Operating Instructions.

### Diagnostics buffer

If an error occurs, the IM 151-8 PN/DP CPU interface module writes the cause of error to the diagnostics buffer. In *STEP 7* you use the programming device to read the diagnostics buffer. This location holds error information in plain text.

Modules with diagnostics capability that do not have their own diagnostics buffer write their error information to the IM 151-8 PN/DP CPU interface module’s diagnostics buffer.

When an error or an interrupt event occurs, (e.g. diagnostic interrupt for an I/O module), the IM 151-8 PN/DP CPU interface module switches to STOP mode, or you can respond in the user program via error / interrupt OBs. This would be OB82 in the above example.

### Diagnostics of field devices on PROFINET

For additional information, refer to the PROFINET (<http://support.automation.siemens.com/WW/view/en/19292127>) System Description and to the From PROFIBUS DP to PROFINET IO (<http://support.automation.siemens.com/WW/view/en/19289930>) Programming Manual.



## Diagnostics with system functions

On the IM 151-8 PN/DP CPU interface module, we recommend that you use the more user-friendly **SFB 54** "RALRM" (called in diagnostic OB 82) to evaluate the diagnostics from I/O modules or DP slaves.

Further options for diagnostics with system functions are listed below:

- Using **SFC 51** "RDSYSST" to read an SSL sublist or an extract thereof.
- Reading the diagnostic data (slave diagnostics) of a DP slave, using **SFC 13** "DPNRM\_DG"

Every DP slave provides slave diagnostic data according to EN 50170 Volume 2, PROFIBUS. You can use SFC 13 "DPNRM\_DG" to read this diagnostic data. Error information is stored in hex code. Refer to the relevant module manual for information on the meaning of the read code.

For example, the entry of the value 50H (= dual 0101 0000) in byte 7 of the slave diagnostics for the distributed I/O module ET 200B indicates a faulty fuse or missing load voltage in channel group 2 and 3.

- Reading a data record with **SFB 52** "RDREC"

You can use SFB 52 "RDREC" (read record) to read a specific data record from the addressed module. Data records 0 and 1 are especially suitable for reading diagnostic information from a diagnosable module.

Data record 0 contains 4 bytes of diagnostic data that indicates the current state of a module. Data record 1 contains the 4 bytes of diagnostic data also stored in data record 0, plus module-specific diagnostic data.

- Reading the start information of the current OB using **SFC 6** "RD\_SINFO"

Information about the error can also be found in the start information of the relevant error OB.

You can use SFC 6 "RD\_SINFO" (read start information) to read the start information of the OB that was last called and not yet processed completely, and of the startup OB that was last called.

- Triggering detection of the bus topology in a DP master system with **SFC 103** "DP\_TOPOL"

The diagnostic repeater makes it easier to identify faulty modules or an interruption on the DP cable when a fault occurs during operation. The repeater acts as a slave and is able to determine the topology of a DP segment and log faults on the basis of this topology.

You can use SFC103 "DP\_TOPOL" to trigger the identification of the bus topology of a DP master system by the diagnostic repeater. SFC 103 is described in the *STEP 7 online help* and in the System and Standard Functions for S7-300/400

(<http://support.automation.siemens.com/WW/view/en/1214574>) reference manual. The diagnostic repeater is described in the Diagnostic Repeater for PROFIBUS DP (<http://support.automation.siemens.com/WW/view/en/7915183>) Manual.

### 11.4.3 Diagnostic functions available in STEP 7

#### Diagnosing with the "Diagnosing hardware" function"

Locate the cause of a module error by viewing the online information on the module. You can locate the cause of an error in the user program cycle with the help of the diagnostics buffer and of the stack content. In addition to this, you can check whether a user program is capable of running on the IM 151-8 PN/DP CPU interface module.

Hardware diagnostics give you an overview of the PLC status. In an overview representation, a symbol can display the error status of every module. A double-click on the faulty module opens detailed error information. The scope of this information depends on the specific module. You can view the following information:

- General information about the module (e.g. order number, version, designation) and state of the module (e.g. faulty).
- Module errors (channel errors, for example) in centralized I/O modules and PROFIBUS DP slaves or PROFINET IO devices.
- Maintenance information: Maintenance requirement and maintenance demanded
- Display of messages from the diagnostics buffer.
- Diagnostic data about the PROFINET interface and its ports is also available (e.g. network connection, communication diagnostics and statistics).

For the IM 151-8 PN/DP CPU interface module, you can also view the following information about the module states:

- Cause of an error in the user program cycle.
- Indication of the cycle time (longest, shortest and last cycle).
- Performance data (number of possible inputs and outputs, memory bits, counters, timers and blocks).

For complete and current details of diagnostic functions in *STEP 7* and specific procedures, refer to the *Programming with STEP 7* manual and the *STEP 7 Online Help*.

## 11.4.4 Network infrastructure diagnostics (SNMP)

### Availability

As an open standard, you can use any systems or software solutions for diagnostics based on SNMP in PROFINET.

### Network Diagnostics

SNMP (Simple Network Management Protocol) makes use of the wireless UDP transport protocol. It consists of two network components, similar to the client/server model. The SNMP manager monitors the network nodes and the SNMP agents collect the various network-specific information in the individual network nodes and stores it in a structured form in the **MIB** (Management Information Base). This information allows a network management system to run detailed network diagnostics.

### MIB

An MIB (Management Information Base) is a database of a device. SNMP clients access this database in the device. The S7 device family supports, among others, the following standard MIBs:

- MIB II, standardized in the RFC 1213
- LLDP-MIB, standardized in the international standard IEE 802.1AB
- LLDP PNIO-MIB, standardized in the international standard IEE 61158-6-10

### Detecting the network topology

LLDP (Link Layer Discovery Protocol) is a protocol that is used to detect the closest neighbors. It enables a device to send information about itself and to save information received from neighboring devices in the LLDP MIB. This information can be looked up via the SNMP. This information allows a network management system to determine the network topology.

### Integrating HMI devices via the SNMP OPC server

Configuration of the OPC server is integrated into *STEP 7* HW Config. The communication with the OPC server is carried out without an S7 connection. You therefore do not need to configure S7 connections.

Stations that have already been configured in the *STEP 7* project can be transferred directly. As an alternative to *STEP 7*, the configuration can also be run with the NCM PC (included on the SIMATIC NET CD) or can be determined automatically and transferred to the project configuration.

### Use of SNMP in the SIMATIC NET environment

SNMP-compliant devices from the SIMATIC NET family can be monitored and operated via a conventional standard Internet browser. The management system known as web-based management offers a range of device-specific information (network statistics, status of redundant supply, for example).

### Diagnostics with the SIMATIC NET SNMP OPC server

The SNMP OPC server software enables the diagnostics and parameter assignment of any SNMP devices, even via, for example, HMI devices that cannot read SNMP variables from other devices.

The OPC server uses the SNMP protocol to exchange data with these devices.

All information can be integrated into OPC-compatible systems, into the WinCC HMI system, for example. This enables process and network diagnostics to be combined in the HMI system.

### Uses of SNMP

SNMP can be used as follows:

- By users to integrate network diagnostics into a central HMI/SCADA system using the SNMP OPC server.
- By the IT administrators of machine and system operators to monitor their Industrial Ethernet network using standard network management systems.
- By the IT administrators to primarily monitor the office network, but often also the automation network using standard network management systems (for example, HP Openview).

### Additional information

- Information relating to SNMP from the network management standardization group can be found on the Internet (<http://www.profibus.com>).
- Additional information on SNMP can be found on the Internet (<http://www.snmp.org>).
- Additional information on SNMP OPC servers can be found on the Internet (<http://www.siemens.com/snmp-opc-server>).
- The PROFINET system description (<http://support.automation.siemens.com/WW/view/en/19292127>) contains additional information about the SNMP communication service and diagnostics with SNMP.

## 11.5 Diagnostics using status and error LEDs

### 11.5.1 Introduction

Diagnostics with LEDs is an initial tool for error localization. Usually, you evaluate the diagnostics buffer for further error localization.

The buffer contains plain text information on the error that has occurred. For example, you will find the number of the appropriate error OB here. If you generate this error OB, you can prevent the IM 151-8 PN/DP CPU interface module switching to STOP mode.

### 11.5.2 Status and error displays of the IM 151-8 PN/DP CPU interface module

Table 11- 3 Status and error displays of the IM 151-8 PN/DP CPU interface module

LED						Meaning
SF	MT	ON	FRCE	RUN	STOP	
Off	Off	Off	Off	Off	Off	The IM 151-8 PN/DP CPU has no power supply. Remedy: Check whether the supply voltage is connected to mains and switched on.
Off	X	On	X	Off	On	The IM 151-8 PN/DP CPU is in STOP mode. To correct or avoid error: Start the IM 151-8 PN/DP CPU interface module.
On	X	On	X	Off	On	The IM 151-8 PN/DP CPU is in STOP mode as a result of an error. To correct or avoid error: refer to the tables below, evaluation of the SF LED
X	X	On	X	Off	Flashes (0.5 Hz)	The IM 151-8 PN/DP CPU requests a memory reset.
X	X	On	X	Off	Flashes (2 Hz)	The IM 151-8 PN/DP CPU carries out a memory reset.
X	X	On	X	Flashes (2 Hz)	On	The IM 151-8 PN/DP CPU is in start-up mode.
X	X	On	X	Flashes (0.5 Hz)	On	The IM 151-8 PN/DP CPU was paused by a programmed break point. For further information, refer to the Programming with STEP 7 ( <a href="http://support.automation.siemens.com/WW/view/en/18652056">http://support.automation.siemens.com/WW/view/en/18652056</a> ) Manual.
On	X	On	X	X	X	Hardware or software error To correct or avoid error: refer to the tables below, evaluation of the SF LED

11.5 Diagnostics using status and error LEDs

LED						Meaning
SF	MT	ON	FRCE	RUN	STOP	
X	On	X	X	X	X	<ul style="list-style-type: none"> <li>• During IRT operation of a PROFINET IO system:                             <ul style="list-style-type: none"> <li>– Failure of the Sync Master in a Sync Domain</li> <li>– Loss of synchronization with its own CPU (e. g. due to failure of the Sync Master)</li> <li>– Loss of synchronization with a connected PROFINET IO device</li> </ul> </li> <li>• Other PROFINET IO maintenance demand (e.g. excessive attenuation in fiber-optic cables)</li> <li>• In the case of media redundancy (MRP):                             <ul style="list-style-type: none"> <li>– Connection between ring ports is missing or interrupted</li> <li>– An MRP client in the ring has failed</li> <li>– If several redundancy managers are present</li> </ul> </li> </ul>
X	X	X	On	X	X	You enabled the Force function For further information, refer to the Programming with STEP 7 manual. ( <a href="http://support.automation.siemens.com/WW/view/en/18652056">http://support.automation.siemens.com/WW/view/en/18652056</a> )
X	X	X	Flashes (2 Hz)	X	X	Node flashing test was activated.
Flashes	X	Flashes	Flashes	Flashes	Flashes	There is an internal system error in your IM 151-8 PN/DP CPU. The procedure is as follows: <ol style="list-style-type: none"> <li>1. Set the mode selector switch to STOP.</li> <li>2. Switch the supply voltage 1L+ off and on again.</li> <li>3. Read the diagnostics buffer with <i>STEP 7</i>.</li> <li>4. Read the service data (see section "Reading/saving service data (Page 201)" )</li> <li>5. Contact your local SIEMENS partner.</li> </ol>
Flashes (2 Hz)	Off	Off	Off	Off	Off	The IM151-8 PN/DP CPU has no valid firmware; To correct or avoid error: Perform a firmware update with a Micro Memory Card (see section Firmware update with a Micro Memory Card (Page 183)).

X = This state is irrelevant for the current IM 151-8 PN/DP CPU function.

**Maintenance information MT**

The LED MT lights up yellow as soon as a **maintenance demand** is received from the PROFINET IO.

In addition to the LED display, an alarm message is generated if these interrupts have been enabled by the configuration of the PN interface.

## Reference

- A detailed description of the OBs and SFCs required for their evaluation can be found in the *STEP 7 Online Help* and in the S7-300/400 System and Standard Functions (<http://support.automation.siemens.com/WW/view/en/1214574>) Reference Manual.
- For detailed information on maintenance, refer to the PROFINET System Description (<http://support.automation.siemens.com/WW/view/en/19292127>).

### 11.5.3 Evaluating the SF LED in case of software errors

Table 11- 4 Evaluation of the SF LED (software error)

Possible error	Response of the IM 151-8 PN/DP CPU interface module	Possible Remedies
TOD interrupt is enabled and triggered. However, a matching block is not loaded. (Software/configuration error)	Call of OB 85. The IM 151-8 PN/DP CPU interface module STOPS if OB 85 is not loaded.	Load OB 10 (OB number can be seen from the diagnostics buffer).
Start time of the enabled TOD interrupt was jumped, e.g. by advancing the internal clock.	Call of OB 80. The IM 151-8 PN/DP CPU interface module STOPS if OB 80 is not loaded.	Disable the TOD interrupt before you set the time-of-day with SFC 29.
Delay interrupt triggered by SFC 32. However, a matching block is not loaded. (Software/configuration error)	Call of OB 85. The IM 151-8 PN/DP CPU interface module STOPS if OB 85 is not loaded.	Load OB 20 (OB number can be seen from the diagnostics buffer).
Process interrupt is enabled and triggered. However, a matching block is not loaded. (Software/configuration error)	Call of OB 85. The IM 151-8 PN/DP CPU interface module STOPS if OB 85 is not loaded.	Load OB 40 (OB number can be seen from the diagnostics buffer).
Status alarm is generated, but the appropriate OB55 is not loaded.	Call of OB 85. The IM 151-8 PN/DP CPU interface module STOPS if OB 85 is not loaded.	Load OB55
Update alarm is generated, but the appropriate OB 56 is not loaded.	Call of OB 85. The IM 151-8 PN/DP CPU interface module STOPS if OB 85 is not loaded.	Load OB56
Vendor-specific alarm is generated, but the appropriate OB57 is not loaded.	Call of OB 85. The IM 151-8 PN/DP CPU interface module STOPS if OB 85 is not loaded.	Load OB57
Access to missing or defective I/O module when the process image is updated (software or hardware error)	Call OB 85 (depending on the parameter settings in HW Config). The IM 151-8 PN/DP CPU interface module STOPS if OB 85 is not loaded.	Load OB 85. The start information of the OB contains the address of the relevant I/O module. Replace the affected I/O module or eliminate the program error.

11.5 Diagnostics using status and error LEDs

Possible error	Response of the IM 151-8 PN/DP CPU interface module	Possible Remedies
The cycle time was exceeded. Probably too many interrupt OBs called simultaneously.	Call of OB 80. The IM 151-8 PN/DP CPU interface module STOPS if OB 80 is not loaded. The IM 151-8 PN/DP CPU interface module switches to STOP even though OB 80 is loaded if twice the cycle time was exceeded without the cycle time being triggered again.	Extending the cycle time ( <i>STEP 7</i> –Hardware configuration), changing the program structure.  To correct or avoid error: If necessary, retrigger cycle time monitoring by calling SFC 43
Programming error <ul style="list-style-type: none"> <li>• Block not loaded</li> <li>• Wrong block number</li> <li>• Wrong timer/counter number</li> <li>• Read/write access to wrong area</li> <li>• etc.</li> </ul>	Call of OB 121. The IM 151-8 PN/DP CPU interface module STOPS if OB 121 is not loaded.	Eliminate the programming error. The <i>STEP 7</i> testing function helps you to locate the error.
I/O access errors An error has occurred when I/O module data was accessed	Call of OB 122. The IM 151-8 PN/DP CPU interface module STOPS if OB 122 is not loaded.	Check the I/O module address assignment in HW Config and identify whether an I/O module / DP slave / PROFINET IO device has failed.

**Tip:**

- You can use SFC 39 to disable all interrupts and asynchronous error events.

**Note**

The shorter the selected cyclic interrupt period, the more likely it is that cyclic interrupt errors will occur. You must take into account the operating system times of the IM 151-8 PN/DP CPU interface module, the user program runtime and extension of the cycle time by active programming device functions, for example.

**Reference**

A detailed description of the OBs and on SFCs required for their evaluation can be found in the *STEP 7 Online Help* and in the *S7-300/400 System and Standard Functions* reference manual.



## 11.5.4 Evaluating the SF LED in case of hardware errors

Table 11- 5 Evaluating the SF LED (hardware error)

Possible error	Response of the IM 151-8 PN/DP CPU interface module	Possible Remedies
A centralized I/O module was removed or inserted while the system was in RUN mode.	Call of OB 83. The IM 151-8 PN/DP CPU interface module STOPS if OB 83 is not loaded. If more than one module is removed, the IM 151-8 PN/DP CPU interface module always switches to STOP.	Load OB 83.
A distributed module was removed or inserted on PROFINET IO while the system was in RUN.	Call of OB 83. The IM 151-8 PN/DP CPU interface module STOPS if OB 83 is not loaded. OB 86 is also called when one or more modules of an ET 200S (IO device) are removed or inserted while the system is in RUN. The IM 151-8 PN/DP CPU interface module STOPS if OB 86 is not loaded.	Load OB 83 and OB 86.
A distributed module was removed from or inserted on the PROFIBUS DP while the system was in RUN mode.	Call of OB 86. The IM 151-8 PN/DP CPU interface module STOPS if OB 86 is not loaded. If the module was integrated using a GSD file: Call of OB 82. The IM 151-8 PN/DP CPU interface module STOPS if OB 82 is not loaded.	Load OB86 or OB82.
An I/O module with diagnostic capability reports a diagnostic interrupt.	Call of OB 82. The IM 151-8 PN/DP CPU interface module STOPS if OB 82 is not loaded.	Response to the diagnostic event, which depends on the parameter assignments for the I/O module.
Attempt to access a missing or faulty I/O module. Loose connector (software or hardware error).	Call of OB 85, if access was attempted during update of the process image (OB 85 call must be enabled accordingly in the parameters). Call OB 122 for direct I/O access. The IM 151-8 PN/DP CPU interface module STOPS if an OB is not loaded.	Load OB 85 or OB 122. The start information of the OB contains the address of the relevant I/O module. Replace the relevant I/O module, fix the connector or eliminate the program error.
SIMATIC Micro Memory Card is faulty.	The IM 151-8 PN/DP CPU switches to STOP and requests a memory reset.	Replace the SIMATIC Micro Memory Card, reset the IM 151-8 PN/DP CPU interface module memory, transfer the program again, then set the IM 151-8 PN/DP CPU interface module to RUN mode.

Possible error	Response of the IM 151-8 PN/DP CPU interface module	Possible Remedies
A port interconnection was configured but either no partner or an incorrect partner was detected at the port.	<p>If no partner device is present or an incorrect partner device is connected, this leads to a respective diagnostics buffer entry and a display in the communication diagnostics of the port at the PN interface.</p> <p>If the call of an OB 82 for communication interrupts at the PN interface is enabled in the HW config, then when the IM is in RUN mode and the corresponding event occurs, the OB 82 is called here also.</p>	Create a connection to the correct partner.
<p>The IM151-8 PN/DP CPU is operated as an I device at an IO controller (can also be a CPU) in a PN IO subnet.</p> <p>One of the two communication partners switches to STOP mode (or is in STOP mode).</p>	<p>The IO controller is in RUN mode and the I device is in STOP mode:</p> <ul style="list-style-type: none"> <li>• Direct I/O access to inputs / outputs in the application transfer areas / I/O transfer areas to the I devices lead to access errors in the IO controller (call OB 122).</li> <li>• If the application transfer areas / I/O transfer areas are within the process image and the call of the OB 85 is assigned parameters in the case of process image transfer errors, then in this case the OB 85 is called.</li> </ul> <p>The IO controller is in STOP mode and the I device is in RUN mode:</p> <ul style="list-style-type: none"> <li>• Access errors in the I device (call OB 122).</li> <li>• If the application transfer areas are within the process image and the call of the OB 85 is assigned parameters in the case of process image transfer errors, then in this case the OB 85 is called.</li> </ul>	Load OB85 or OB122.

**Reference**

A detailed description of the OBs and on SFCs required for their evaluation can be found in the *STEP 7 Online Help* and in the *S7-300/400 System and Standard Functions* reference manual.

## 11.5.5 Status and error displays for the PN interface

### Status and Error Indicators: PROFINET devices

Table 11-6 LED displays for PROFINET

LED	LED status	Description of the status
P1 - LINK, P2 - LINK, P3 - LINK	Lit	There is an Ethernet connection between the allocated port of the PROFINET interface of your PROFINET device and a communication peer on the Ethernet (a switch, for example).
	Flashes	Only for IO devices does the "Flashing node test" by the SIMATIC Manager result in the LINK LED flashing.  The LINK LED can also be induced to flash for CPUs, for instance, by calling up "Search the Network" from the HW config (Target system > Ethernet > Edit Ethernet Nodes > Search).  Comments: For CPUs, the usual "Flashing node test" results in the FORCE LED flashing.
	If it does not light up	The Ethernet connection between the PROFINET interface of the PROFINET device and the communication partner is down.
BF-PN	lit <sup>1</sup>	Error on the PROFINET interface, communication no longer possible (for example, with a CPU as IO controller, when the connection to the switch is down)  To correct or avoid error: See the table below
	Flashes	The BF LED always flashes if, from the point of view of the PROFINET IO controller, the communication cannot be correctly established to any device (due, for instance, to a CPU failure of one or more IO devices).  Communication via a PROFINET interface port can in principle be performed.  For a CPU that is operated as an I device, the BF LED flashes until one controller has correctly established communication to this device.  To correct or avoid error: See the table below
	If it does not light up	No error at the PROFINET interface

- 1 The BF-PN LED only lights up if a PROFINET IO system is configured. If the BF-PN LEDs do not light up because the PROFINET IO system is not to be used, for example, then the PROFINET IO system must be separated or deleted from the configuration in HW Config.

**Remedy for errors at the PROFINET interface - BF-PN LED lights up**

Table 11- 7 BF-PN LED lights up

Possible error	Example response of the IM 151-8 PN/DP CPU interface module	Possible remedies
<ul style="list-style-type: none"> <li>• Bus fault (no cable connection to a subnet/switch)</li> <li>• Wrong transmission speed</li> <li>• Full duplex mode is not activated.</li> </ul>	<p>Call OB 86 (if the IM 151-8 PN/DP CPU interface module is in RUN mode and has previously run IO devices that have now failed).</p> <p>The IM 151-8 PN/DP CPU interface module STOPS if OB 86 is not loaded.</p>	<ul style="list-style-type: none"> <li>• Check the bus cable for a short-circuit or break.</li> <li>• Check whether the IM 151-8 PN/DP CPU interface module is connected to a switch and not to a hub.</li> <li>• Check that data are being transmitted at 100 Mbps and in full duplex mode.</li> <li>• Evaluate the diagnostics. Edit the configuration.</li> <li>• If a DP master module is connected to your IM 151-8 PN/DP CPU interface module, then you can read out the diagnostics via the DP master interface. Edit the configuration.</li> </ul>

**Remedy for errors at the PROFINET interface of an IO controller - BF-PN LED flashes**

Table 11- 8 BF-PN LED flashes with a PROFINET IO controller

Possible error	Example response of the IM 151-8 PN/DP CPU interface module	Possible remedies
<ul style="list-style-type: none"> <li>• Failure of a connected IO device</li> <li>• If at least one of the assigned IO devices cannot be assigned an address.</li> <li>• Bad engineering configuration</li> </ul>	<p>Call OB 86 (if the IM 151-8 PN/DP CPU interface module is in RUN mode and before occurrence of the error had previously run PROFINET IO devices that have now failed).</p> <p>The IM 151-8 PN/DP CPU interface module STOPS if OB 86 is not loaded.</p>	<ul style="list-style-type: none"> <li>• Check whether the Ethernet cable is connected to the IM 151-8 PN/DP CPU interface module and that the bus is not interrupted.</li> <li>• Wait until the IM 151-8 PN/DP CPU interface module has started up. If the LED does not stop flashing, check the IO devices or evaluate their diagnostic information.</li> <li>• Check whether the configured device name matches its actually assigned name.</li> <li>• Check whether the connected IO devices have different device names and IP addresses.</li> </ul>

## Remedy with errors on the PROFINET interface of an I device - BF2/ BF3 LED flashes

Table 11- 9 BF2/ BF3 LED flashes on an I device

Possible error	Reaction based on the example of a CPU	Possible remedies
When configured as an I device with no lower-level IO system:		
<ul style="list-style-type: none"> <li>Wrong IP address</li> <li>Bad engineering configuration</li> <li>Wrong parameter assignment</li> <li>IO controller not found / switched off, but there is an Ethernet connection.</li> <li>In Shared I device mode: If all configured IO controllers are unavailable or are switched off, but the Ethernet connection is up (link to a neighboring device is active).</li> <li>Bad or no device name</li> <li>The response monitoring time has expired.</li> </ul>	<p>Call OB 86 if the IM 151-8 PN/DP CPU interface module is in RUN mode and the user data communication to the higher-level IO controller(s) has failed.</p> <p>The IM 151-8 PN/DP CPU interface module STOPS if OB 86 is not loaded.</p> <p>When the IM151-8 PN/DP CPU is being used as a shared I device, the BF does not flash unless the communication to both the higher-level controllers has failed.</p>	<ul style="list-style-type: none"> <li>Check that the Ethernet cable is correctly connected.</li> <li>Check whether the Ethernet cable to the controller is interrupted.</li> <li>Check the configuration and parameter assignment, especially the IP addresses and device names.</li> <li>Switch on the IO controller.</li> <li>Check whether the expected configuration matches the actual configuration.</li> <li>Check the physical communication connection for interruptions.</li> <li>Wait until the IM 151-8 PN/DP CPU has started up. If the LED still persists in flashing, check the IO controller(s) and evaluate the diagnostics buffer of the IO controller(s) and the I device.</li> </ul>
In addition, when configured as an I device with a lower-level IO system:		
<ul style="list-style-type: none"> <li>Failure of a connected IO device</li> <li>At least one of the assigned IO devices cannot be addressed</li> <li>Bad engineering configuration</li> </ul>	<p>Call OB 86 (if the IM 151-8 PN/DP CPU interface module is in RUN mode and before occurrence of the error had previously run PNIO devices that have now failed).</p> <p>The IM 151-8 PN/DP CPU interface module STOPS if OB 86 is not loaded.</p>	<ul style="list-style-type: none"> <li>Check that the Ethernet cable is connected to the module or whether the bus is interrupted.</li> <li>Wait until the CPU has completed its startup. If the LED persists in flashing, check the IO devices or evaluate their diagnostic information.</li> <li>Check whether the configured device name matches its actually assigned name.</li> <li>Check whether the connected IO devices have different device names and IP addresses.</li> </ul>

### 11.5.6 Status and Error Indicators: PROFINET IO Devices

#### Troubleshooting errors on the PROFINET interface of an IO device and in mixed mode with IO controller/I device - BF LED flashes

Table 11- 10 BF LED flashes on a PROFINET IO device

Possible problem	Possible remedies
<ul style="list-style-type: none"> <li>• The IP address is incorrect</li> <li>• Bad engineering configuration</li> <li>• Bad parameter assignment</li> <li>• IO controller not found / switched off, but there is an Ethernet connection.</li> <li>• In Shared I-Device mode: All configured IO controllers are not available or are switched off, but the Ethernet connection is up (link to a neighboring device is active)</li> <li>• Incorrect or missing device name</li> <li>• The response monitoring time has expired.</li> <li>• In IRT mode with "high performance": Connection to the sync master is down</li> </ul>	<ul style="list-style-type: none"> <li>• Check that the Ethernet cable is correctly connected.</li> <li>• Check whether the Ethernet cable to the controller is interrupted.</li> <li>• Check the configuration data and parameters.</li> <li>• On the IO device: Switch on the IO controller.</li> <li>• Check whether the expected configuration matches the actual configuration.</li> <li>• Check the physical communication connection for interruptions.</li> </ul>

#### Tip: Identification of the PROFINET device in the cubicle

When they are first commissioned, PROFINET IO devices must be assigned a device name. In STEP 7/HW Config, you can make the LINK LED of a named PROFINET IO device flash using **Target system > Ethernet > Assign Device Name** . This allows you, for example, to clearly identify a PROFINET IO device among several identical devices in a control cabinet.

#### Maintenance LED

This LED indicates that a maintenance request is pending, e.g., loss of synchronization of the own station.

For additional information, refer to the STEP 7 online help.

## 11.5.7 Status and error displays of the DP master module

### Explanation of the BF LED

Table 11- 11 BF LED

Meaning			
IM 151-8 PN/DP CPU		DP master module	
SF	ON	BF	
On	On	On/flashes	PROFIBUS DP interface error. To correct or avoid error: See the tables below

Table 11- 12 BF LED on the DP master module lights up

Possible error	Response of the IM 151-8 PN/DP CPU interface module	Possible remedies
<ul style="list-style-type: none"> <li>Bus fault (hardware fault).</li> <li>Slave not available or switched off</li> <li>Short-circuit on the bus</li> </ul>	Call of OB 86 (if the IM 151-8 PN/DP CPU interface module is in RUN and has previously run DP slaves that are now failing).  The IM 151-8 PN/DP CPU interface module STOPS if OB 86 is not loaded.	<ul style="list-style-type: none"> <li>Check to see if the connector for PROFIBUS DP is inserted properly.</li> <li>Check the bus cable for a short-circuit or break.</li> <li>Analyze the diagnostic data. Edit the configuration.</li> </ul>

Table 11- 13 BF LED on the DP master module flashes

Possible error	Response of the IM 151-8 PN/DP CPU interface module	Possible remedies
The IM 151-8 PN/DP CPU interface module is the DP master: <ul style="list-style-type: none"> <li>Failure of a connected station</li> <li>At least one of the configured slaves cannot be accessed.</li> <li>Incorrect configuration (configured address areas of the actual structure do not correspond with the set structure.)</li> </ul>	Call of OB 86 (if the IM 151-8 PN/DP CPU interface module is in RUN and connected DP slaves have since failed).  The IM 151-8 PN/DP CPU interface module STOPS if OB 86 is not loaded.	<ul style="list-style-type: none"> <li>Check whether the bus cable on the DP master module is connected to the IM 151-8 PN/DP CPU interface module and that the bus is not interrupted.</li> <li>Wait until the IM 151-8 PN/DP CPU interface module has started up. If the LED does not stop flashing, check the DP slaves or evaluate the diagnostic data for the DP slaves.</li> <li>Check the settings for the configured address areas for the DP master.</li> </ul>

### Reference

A detailed description of the OBs and on SFCs required for their evaluation can be found in the *STEP 7 Online Help* and in the *S7-300/400 System and Standard Functions* reference manual.

## 11.6 Diagnostics on the PROFIBUS DP

### 11.6.1 Diagnostics of the IM 151-8 PN/DP CPU interface module as a DP master

#### Evaluate diagnostics in the user program

The figure below illustrates the procedure for evaluating diagnostics data in the user program.

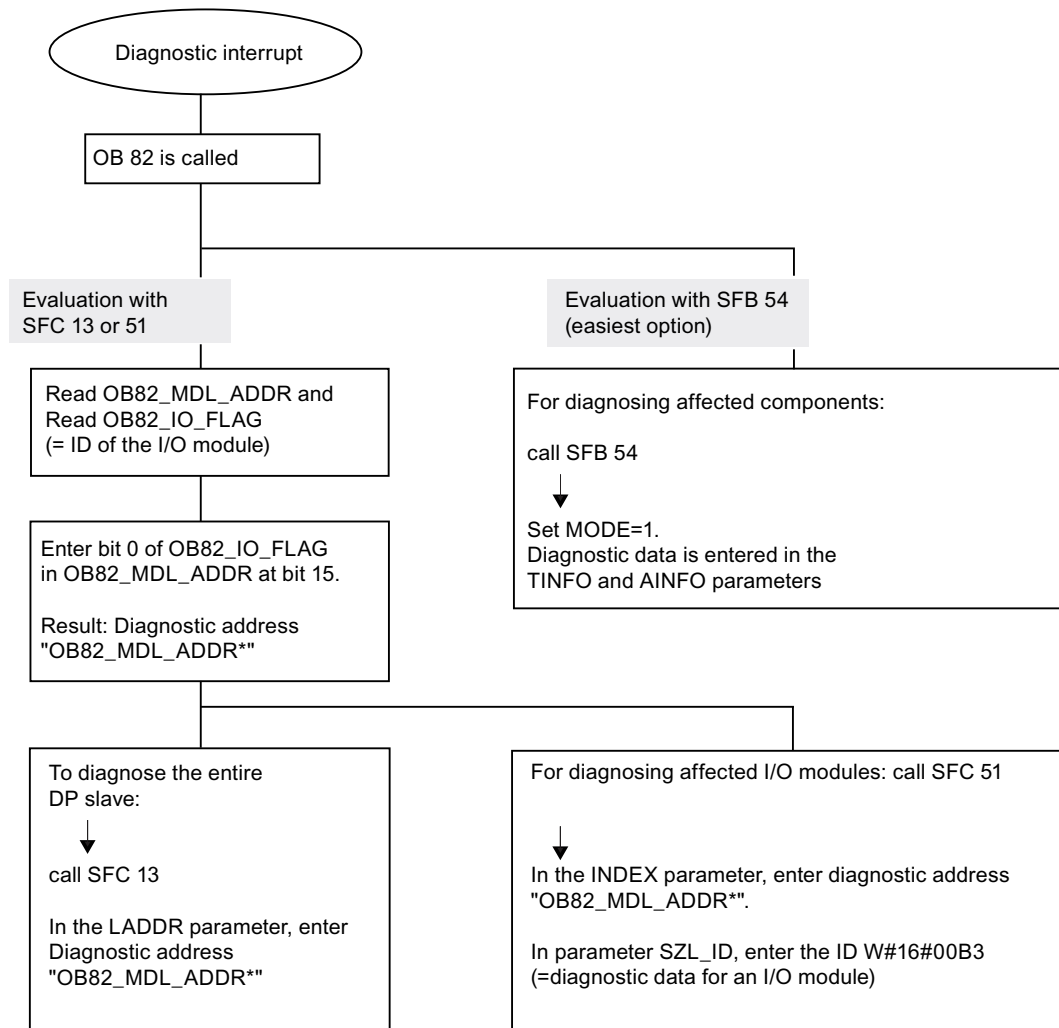

Note:  
 SFC 13 is asynchronous, which means that it may be called multiple times until its state has changed to BUSY=0.

Initial call in OB 82,  
 execution completed in the cycle



### Diagnostics addresses for DP masters and DP slaves

With IM 151-8 PN/DP CPU interface module you assign diagnostics addresses for the PROFIBUS DP. Verify in your configuration that the DP diagnostics addresses are assigned once to the DP master and once to the DP slave.

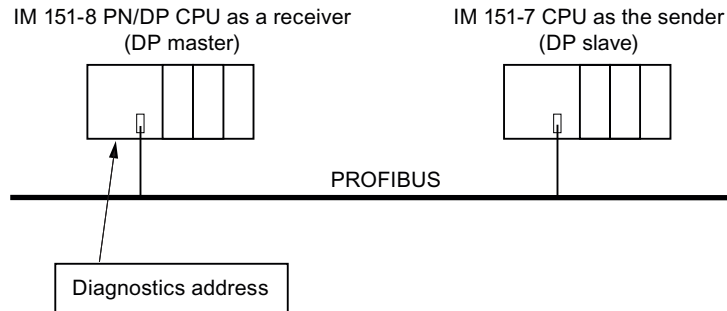

Explanation of the DP master configuration	Explanation of the DP slave configuration
<p>When you configure the DP master, assign two different diagnostics addresses for an intelligent DP slave, that is, one diagnostics address for slot 0, and one for slot 2. These two addresses perform the following functions:</p> <ul style="list-style-type: none"> <li>• The diagnostics address for slot 0 reports in the master all events relating to the entire slave (station representative), for example, node failure.</li> <li>• The diagnostics address for slot 2 is used to report events concerning this slot. For example, if the IM 151-7 CPU is acting as an intelligent slave, it returns the diagnostic interrupts for operating state transitions.</li> </ul> <p>These diagnostics addresses are referred to as <i>assigned to the DP master</i> below.</p> <p>These diagnostics addresses are used by the DP master to obtain information about the state of the DP slave, or about bus interruptions.</p>	<p>When you configure the DP slave, you also assign it a diagnostics address (in the associated DP slave project).</p> <p>This diagnostics address is referred to as <i>assigned to the DP slave</i> below.</p> <p>This diagnostics addresses is used by the DP slave to obtain information about the state of the DP master, or bus interruptions.</p>

**Event detection**

The table below shows how the IM 151-8 PN/DP CPU interface module acting as a DP master recognizes operating mode transitions of a CPU acting as a DP slave or any interruption of the data exchange.

Table 11- 14 Event recognition of the IM 151-8 PN/DP CPU interface module as a DP master

Event	What happens in the DP master?
Bus interruption (short circuit, connector removed)	<ul style="list-style-type: none"> <li>• Call of OB 86 with the message <b>Station failure</b> (incoming event; diagnostics address of Slot 0 of the DP slave that is assigned to the DP master)</li> <li>• With I/O access: call of OB 122 (I/O access error)</li> </ul>
DP slave: RUN → STOP	<ul style="list-style-type: none"> <li>• Call of OB 82 with the message <b>Module error</b> (incoming event; diagnostics address of Slot 2 of the DP slave that is assigned to the DP master; Variable OB82_MDL_STOP=1)</li> </ul>
DP slave: STOP → RUN	<ul style="list-style-type: none"> <li>• Call of OB 82 with the message <b>Module OK</b>. (outgoing event; diagnostics address of Slot 2 of the DP slave that is assigned to the DP master; Variable OB82_MDL_STOP=0)</li> </ul>

**Evaluation in the user program**

The table below shows how you can, for example, evaluate RUN to STOP transitions of the DP slave in the DP master.

Table 11- 15 Evaluating RUN to STOP transitions of the DP slave in the DP master

In the DP master	In the DP slave (e.g. CPU 31x-2 DP)
Diagnostics addresses: (Example) Master diagnostics address = <b>1023</b> Slave diagnostics address = <b>1022</b> (Slot 0 of slave) (Diagnostic) address for "Slot 2"= <b>1021</b> (Slot 2 of slave)	Diagnostics addresses: (Example) Slave diagnostics address = <b>422</b> Master diagnostics address = irrelevant
The IM 151-8 PN/DP CPU interface module calls OB 82 with the following information: <ul style="list-style-type: none"> <li>• OB82_MDL_ADDR:=<b>1021</b></li> <li>• OB82_EV_CLASS:=B#16#39 (incoming event)</li> <li>• OB82_MDL_DEFECT:=module fault</li> </ul> Tip: This information is also available in the diagnostics buffer of the IM 151-8 PN/DP CPU interface module.  In the user program you should also include SFC 13 "DPNRM_DG" for reading DP slave diagnostic data.	CPU: RUN -> STOP The CPU generates a DP slave diagnostic message frame

## 11.7 Defective configuration statuses of the ET 200S

### Fault indications in the diagnostics buffer

Defective configuration statuses of the ET 200S distributed I/O system are entered in the diagnostics buffer.

Error type	Error location	Cause of error	Remedy
1	04 to 66 (slot) If necessary 67 (bus terminator module)	<p><b>Communication interruption</b></p> <p>Displays the first slot at which no I/O module is recognized.</p> <ul style="list-style-type: none"> <li>• Missing I/O module during POWER ON or several I/O modules are missing during operation.</li> <li>• Interruptions at the rear panel bus</li> <li>• Short-circuit at the rear panel bus ("04" is output as the slot).</li> <li>• Termination module missing.</li> </ul> <p>If the termination module is missing, the number of the inserted I/O modules + 1 are output.</p>	Check the configuration of the ET 200S.

## 11.8 Failure of the load voltage from the power module

### Load voltage failure

Should the load voltage of the power module fail, the electronic modules will behave as follows:

- No output for output modules.
- Substitute values are generated for input modules.

---

#### Note

Electronic modules that are re-parameterized during operation must be parameterized yet again once the load voltage has been restored to the power module.

---

## 11.9 Basics of diagnostics in PROFINET IO

### Totally Integrated Diagnostics Concept

PROFINET IO supports you with an integrated diagnostics concept. The diagnostics concept with PROFINET IO is similar to that of PROFIBUS DP.

Below, we will explain the basics of the concept.

### Basic concept

Each individual or several errors occurring simultaneously are transferred from the IO device to the IO controller.

If you require the full status of the IO device including any pending errors, you can also read the status directly from the IO device.

### Extended maintenance concept

PROFINET devices support the comprehensive diagnostics and maintenance concept described in the IEC 61158-6-10 standard.

The aim of the maintenance concept is the early detection and elimination of potential faults - before they cause a production failure.

The PROFINET devices / modules / submodules can therefore also display information for preventive maintenance, in addition to the status information "OK" and "Faulty".

#### Maintenance information

Maintenance information describes the urgency with which maintenance is needed. The concept distinguishes between two levels of maintenance information:

Maintenance information	Symbol in <i>STEP 7</i>	MT LED status	Example
Maintenance requirement (maintenance required): Maintenance is recommended	green wrench	Off	The attenuation on a fiber-optic conductor is becoming too high. Although operation is still possible, the transmission link may fail completely in the near future.
Maintenance request (maintenance demanded): Maintenance alarm	yellow wrench	Yellow	Failure of the synchronization master in a synchronization domain for the IRT operation of a PNIO system

The times at which maintenance information is generated are defined individually for each wear parameter (e.g. attenuation on a fiber optic cable).

### Information on Diagnostics in PROFINET IO

For additional information, refer to the *STEP 7 Online Help*, the *From PROFIBUS DP to PROFINET IO* programming manual and the *PROFINET System Description*.

The system status lists and data records for PROFINET diagnostics are described in the programming manual.

## Technical data

### 12.1 General technical data

#### Reference

The IM 151-8 PN/DP CPU interface module conforms to the standards and test values that apply to the ET 200S distributed I/O device. Detailed information on the general technical specifications can be found in the *ET 200S Distributed I/O Device Operating Instructions*.

### 12.2 IM 151-8 PN/DP CPU interface module

#### 12.2.1 IM 151-8 PN/DP CPU with DP master module block diagram

The following figure shows the block diagram for the IM 151-8 PN/DP CPU interface module with the optional DP master module.

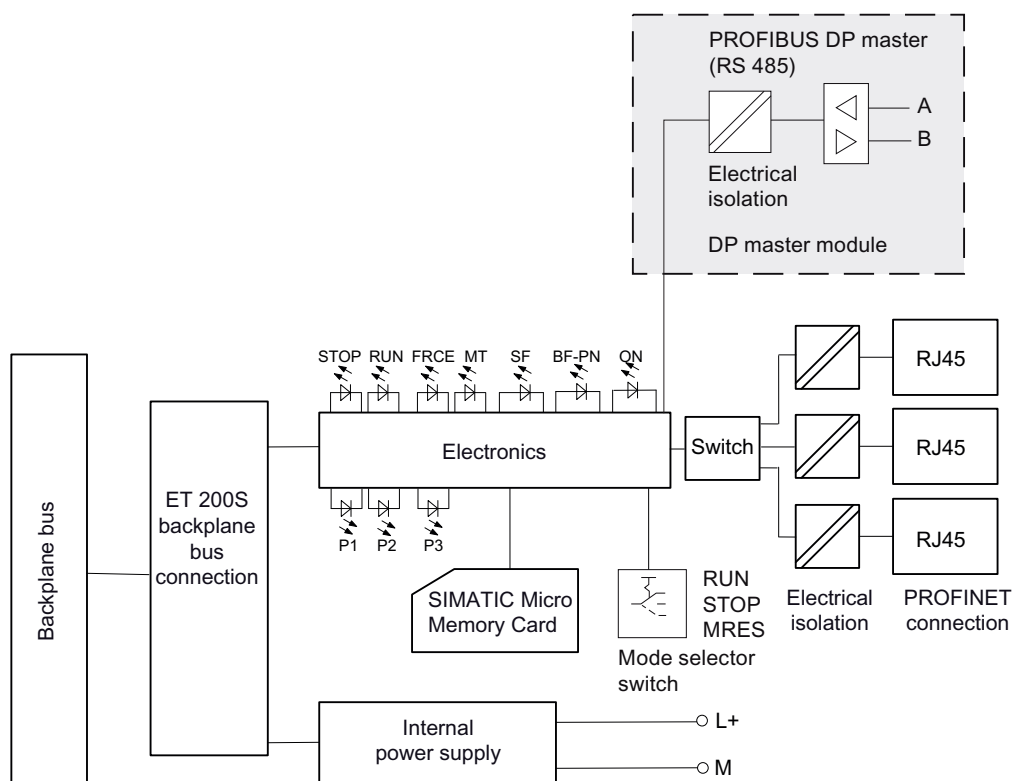

Figure 12-1 IM 151-8 PN/DP CPU interface module with DP master module block diagram

## 12.2.2 IM 151-8 PN/DP CPU technical specifications

Table 12- 1 Technical specifications of the IM 151-8 PN/DP CPU interface module

<b>Technical specifications</b>	
<b>IM 151-8 PN/DP CPU and product version</b>	
Order number	6ES7151-8AB01-0AB0
• Hardware version	01
• Firmware version	V 3.2.0
• Associated programming package	STEP 7 V5.5 and higher
<b>Memory</b>	
Work memory	
• Work memory	192 kB
• Expandable	No
• Capacity of the retentive memory for retentive data blocks	64 KB
Load memory	
• Pluggable (MMC)	Yes
• Pluggable (MMC), max.	8 MB
Buffering	Guaranteed by SIMATIC MMC (maintenance-free)
Data retention on the SIMATIC Micro Memory Card (after final programming)	At least 10 years
<b>Execution times</b>	
Processing times of	
• Bit operations	0.06 µs
• Word instructions	0.12 µs
• Fixed-point arithmetic	0.16 µs
• Floating-point arithmetic	0.59 µs
<b>Timers / counters and their retentivity</b>	
S7 counters	256
• Retentive memory	Configurable
• Default	From C0 to C7
• Counting range	0 to 999
IEC Counters	Yes
• Type	SFB
• Number	Unlimited (limited only by work memory)
S7 timers	256
• Retentive memory	Configurable
• Default	Not retentive
• Timer range	10 ms to 9990 s

<b>Technical specifications</b>	
IEC timers	Yes
• Type	SFB
• Number	Unlimited (limited only by work memory)
<b>Data areas and their retentive address areas</b>	
Bit memory	
• Number, max.	256 Byte
• Retentivity, configurable	Yes, from MB0 to MB255
• Retentivity, preset	From MB0 to MB15
Number of clock memories	8 (1 memory byte)
Local data per priority class, max.	32 kB per runtime level / 2 kB per block
<b>Blocks</b>	
Total number of blocks	1024 (DBs, FCs, FBs) The maximum number of blocks that can be loaded may be reduced if you are using another SIMATIC Micro Memory Card.
OBs	See instruction list
• Size, max.	64 KB
• Number of free-cycle OBs	1 (OB 1)
• Number of time-of-day interrupt OBs	1 (OB 10)
• Number of time-delay interrupt OBs	2 (OB 20, 21)
• Number of cyclic interrupt OBs	4 (OB 32, OB 33, OB 34, OB 35)
• Number of hardware interrupt OBs	1 (OB 40)
• Number of DPV1 interrupt OBs	3 (OB 55, 56, 57)
• Number of isochronous interrupt OBs	1 (OB 61); only for PROFINET IO
• Number of asynchronous error OBs	6 (OB 80, 82, 83, 85, 86, 87) (OB 83 only for centralized I/O and PN IO)
• Number of startup OBs	1 (OB 100)
• Number of synchronous error interrupt OBs	2 (OB 121, 122)
Nesting depth	
• Per priority class	16
• Additional within an error OB	4
FBs	See instruction list
• Number, max.	1024 (in the number range 0 to 7999)
• Size	64 kB
FCs	See instruction list
• Number, max.	1024 (in the number range 0 to 7999)
• Size	64 kB
Data blocks	

<b>Technical specifications</b>	
• Number, max.	1024 (in the number range 1 to 16000)
• Size, max.	64 kB
• Non-retain support (configurable retentive address areas)	Yes
<b>Address areas (I/O)</b>	
Total I/O address area	
• Inputs, freely adressable	2048 bytes
• Outputs, freely adressable	2048 bytes
• Of which distributed	
– Inputs, freely adressable	2048 bytes
– Outputs, freely adressable	2048 bytes
Process I/O image	
• Inputs, adjustable	2048
• Outputs, adjustable	2048
• Inputs, preset	128
• Outputs, preset	128
Process image partitions	
• Number of process image partitions	1
• Volume of user data in the process image partition with an isochronous PROFINET IO, max.	1600 bytes
Digital channels	
• Inputs	16336
• Outputs	16336
• Inputs, central	496
• Outputs, central	496
Analog channels	
• Inputs	1021
• Outputs	1021
• Inputs, central	124
• Outputs, central	124
<b>Removal</b>	
Mounting rail	1
I/O module for each ET 200S	Max. 63
Station width	≤ 1 m or < 2 m
Current carrying capacity per load group (power module)	Max. 10 A
<b>Time-of-day</b>	
Clock	
• Hardware clock (real-time clock)	Yes



<b>Technical specifications</b>	
• Factory setting	DT#1994-01-01-00:00:00
• Buffered, can be synchronized	Yes
• Buffered period	Typically 6 weeks (at an ambient temperature of 40 °C)
• Behavior of the clock on expiration of the buffered period	The clock keeps running, continuing at the time-of-day it had when power was switched off.
• Behavior of the real-time clock after POWER ON	The clock continues running after POWER OFF.
• Deviation per day	typ. 2 s, max. 10 s
<b>Operating hours counter</b>	
• Number	1
• Number	0
• Value range	0 to 2 <sup>31</sup> hours (using the SFC 101)
• Granularity	1 hour
• Retentive	Yes; must be manually restarted after every restart
<b>Time synchronization</b>	
• Supported	Yes
• on PROFINET	Via NTP (only as time-of-day client)
• on PROFIBUS DP	Time-of-day master / time-of-day slave (with DP master module)
<b>S7 message functions</b>	
Number of stations that can be logged on for signaling functions	12 (depends on the number of connections configured for programming device / OP communication)
<b>Process diagnostics messages</b>	
• Supported	Yes
• Simultaneously enabled interrupt S blocks, max.	300
<b>Test and startup functions</b>	
<b>Status/control</b>	
• Monitor/modify variable	Yes
• Variables	Inputs, outputs, memory bits, DBs, timers, counters
• Maximum number of variables	30
• Number of variables, of those status variables, max.	30
• Number of variables, of those modify variables, max.	14
<b>Force</b>	
• Force	Yes
• Forcing, variables	Inputs/Outputs

<b>Technical specifications</b>	
• Maximum number of variables	10
Block status	Yes; (max. 2 blocks simultaneously)
Single-step	Yes
Number of breakpoints	4
Diagnostics buffer	
• Yes	Yes
• Maximum number of entries	500
• Adjustable	No
• of which are power-failure-proof	The last 100 entries are retained.
• Maximum number of entries that can be read in RUN – Adjustable – Default	499 Yes (from 10 to 499) 10
Service data can be read	Yes
Monitoring functions	
Status LEDs	Yes
<b>Communication functions</b>	
PD/OP communication	Yes
Prioritized OCM communication	
• Supported	No
Routing	Yes (with DP master module)
• Connections, max.	4
Data set routing	Yes (with DP master module)
S7 basic communication	
• Supported	Yes (I blocks only)
• User data per job, max.	76 Byte
• User data per job (consistent), max.	76 bytes
S7 communication	
• As server	Yes
• As client	Yes (via integrated PN interface and loadable FBs)
• User data per job, max. • User data per job (consistent), max.	See <i>STEP 7 Online Help, common parameters of SFBs/FBs and SFCs/FCs for S7 communication</i>
• Maximum number of configurable connections	10
• Maximum total number of instances	32
Web server	
• Supported	Yes
• User-defined pages	Yes
• Number of web clients	5
Open IE communication	

<b>Technical specifications</b>	
Open IE communication, supported	Yes
Local port numbers used by the system	0, 20, 21, 23, 25, 80, 102, 135, 161, 8080, 34962, 34963, 34964, 65532, 65533, 65534, 65535
Number of connections / access points, total	8
TCP/IP	Yes (via integrated PROFINET interface and loadable FBs)
• Maximum number of connections	8
• Data length for connection type 01 <sub>H</sub> , max.	1460 bytes
• Data length for connection type 11 <sub>H</sub> , max.	32768 bytes
• Several passive connections per port, supported (multi-port)	Yes
ISO on TCP (RFC1006)	Yes (via integrated PROFINET interface and loadable FBs)
• Maximum number of connections	8
• Data length, max.	32768 bytes
UDP	Yes (via integrated PROFINET interface and loadable FBs)
• Maximum number of connections	8
• Data length, max.	1472 bytes
<b>iPAR server</b>	
iPAR server, supported	Yes
<b>Number of connections</b>	
• Total	12
<b>Suitable for PD communication</b>	
• PD communication, reserved	1
• PD communication, configurable, min.	1
• PD communication, configurable, max.	11
<b>Suitable for OP communication</b>	
• OP communication, reserved	1
• OP communication, configurable, min.	1
• OP communication, configurable, max.	11
<b>Suitable for S7 basic communication</b>	
• S7 basic communication, reserved (default)	0
• S7 basic communication, configurable, min.	0
• S7 basic communication, configurable, max.	10
<b>PROFINET CBA</b>	
Acyclic transmission	Yes
Cyclic transmission	Yes
<b>PROFINET CBA (with reference setting for communication load)</b>	
Reference setting for CPU communication	50%

Technical specifications	
Number of remote interconnecting partners	32
Number of master/slave functions	30
Total of all master/slave connections	1000
Data length of all incoming master/slave connections, max.	4000 bytes
Data length of all outgoing master/slave connections, max.	4000 bytes
Number of device-internal and PROFIBUS interconnections	500
Data length of the device-internal and PROFIBUS interconnections, max.	4000 bytes
Data length per connection, max.	1400 bytes
Remote interconnections with acyclical transmission	
• Scan rate: Scan interval, min.	500 ms
• Number of incoming interconnections	100
• Number of outgoing interconnections	100
• Data length of all incoming interconnections, max.	2000 bytes
• Data length of all outgoing interconnections, max.	2000 bytes
• Data length per connection, (acyclic interconnections), max.	1400 bytes
Remote interconnections with cyclical transmission	
• Transmission frequency: Minimum transmission interval	1 ms
• Number of incoming interconnections	200
• Number of outgoing interconnections	200
• Data length of all incoming interconnections, max.	2000 bytes
• Data length of all outgoing interconnections, max.	2000 bytes
• Data length per connection, (acyclic interconnections), max.	450 bytes
HMI variables via PROFINET (acyclic)	
• Update HMI variables	500 ms
• Number of stations that can be logged on for HMI variables (PN OPC/iMAP)	2x PN OPC / 1x iMAP
• Number of HMI variables	200
• Data length of all HMI variables, max.	2000 bytes
PROFIBUS proxy functionality	
• supported	Yes
• Number of coupled PROFIBUS devices	16

<b>Technical specifications</b>	
• Data length per connection, max.	240 bytes (slave dependent)
<b>1st interface</b>	
Port designation	X1
Type of interface	PROFINET
Physics	RJ45 Ethernet
Isolated	Yes
Integrated switch	Yes
Number of ports	3
Automatic determination of transmission rate	Yes (10/100 Mbps)
Transmission rate, max.	100 Mbps full duplex
Autonegotiation	Yes
Autocrossing	Yes
Media redundancy	Yes
• Switch-over time in the case of cable breakage, typ.	200 ms (PROFINET MRP)
• Number of nodes in the ring, max.	50
Change of the IP address to runtime, supported	Yes
Keep Alive function, supported	Yes
<b>Functionality</b>	
MPI	No
PROFIBUS DP master	No
PROFIBUS DP slave	No
PROFINET IO Controller	Yes; even in combination with IO device functionality
PROFINET IO device	Yes; even in combination with IO controller functionality
PROFINET CBA	Yes
Open IE communication	Yes; via TCP/IP, ISO on TCP, UDP
Web server	Yes
Point-to-point communication	No
<b>PROFINET IO controller</b>	
Services	
PD/OP communication	Yes
Routing	Yes
• S7 routing	Yes (with inserted DP master module)
• Data set routing	Yes (with DP master module inserted, for field devices on the PROFIBUS DP)
S7 communication	Yes; with loadable FBs, max. configurable connections: 10, max. number of instances: 32
Open IE communication	Yes; via TCP/IP, ISO on TCP, UDP
Number of integrated PROFINET IO controllers	1
RT, supported	Yes
IRT supported	Yes

Technical specifications	
Maximum number of connectable I/O devices	128
Maximum number of connectable I/O devices for RT	128
• of which in line, max.	128
Number of IO devices with IRT and the "High Flexibility" option	128
• of which in line, max.	61
Maximum number of IO devices with IRT and the "High Performance" option	64
• of which in line, max.	64
Shared device, supported	Yes
Isochronous mode	Yes (OB 61); only for PROFINET IO
Prioritized start-up, supported	Yes
• Maximum number of I/O devices	32
Activating/deactivating PROFINET IO devices	Yes
• Max. number of I/O devices that can be enabled / disabled simultaneously	8
Hot-swapping of I/O devices (partner ports), supported	Yes
• Maximum number of I/O devices per tool	8
Device replacement without removable medium	Yes
Address area	
Inputs, max.	2048 bytes
Outputs, max.	2048 bytes
Max. user data consistency with PROFINET IO	1024 bytes
Send cycles	250 $\mu$ s, 500 $\mu$ s, 1 ms; 2 ms, 4 ms (not for IRT with the "High Flexibility" option)
Update Time	
Update times	The minimum update time is also determined by the communication set for PROFINET IO, by the number of IO Devices used, and by the volume configured for user data.
For RT	<ul style="list-style-type: none"> <li>• for send clock of 250 <math>\mu</math>s</li> <li>• for send clock of 500 <math>\mu</math>s</li> <li>• for send clock of 1 ms</li> <li>• for send clock of 2 ms</li> <li>• for send clock of 4 ms</li> </ul>
• 250 $\mu$ s to 128 ms	
• 500 $\mu$ s to 256 ms	
• 1 ms to 512 ms	
• 2 ms to 512 ms	
• 4 ms to 512 ms	
For IRT with the "high flexibility" option	<ul style="list-style-type: none"> <li>• for send clock of 250 <math>\mu</math>s</li> <li>• for send clock of 500 <math>\mu</math>s</li> <li>• for send clock of 1 ms</li> </ul>
• 250 $\mu$ s to 128 ms	
• 500 $\mu$ s to 256 ms	
• 1 ms to 512 ms	

<b>Technical specifications</b>	
For IRT with the "high performance" option	<ul style="list-style-type: none"> <li>• for send clock of 250 µs</li> <li>• for send clock of 500 µs</li> <li>• for send clock of 1 ms</li> <li>• for send clock of 2 ms</li> <li>• for send clock of 4 ms</li> </ul>
	<ul style="list-style-type: none"> <li>• 250 µs to 4 ms</li> <li>• 500 µs to 8 ms</li> <li>• 1 ms to 16 ms</li> <li>• 2 ms to 32 ms</li> <li>• 4 ms to 64 ms</li> </ul>
For IRT with the "high performance" option and parameter assignment of "non-whole number" send clocks	Update time = set "non-whole number" send clock (in multiples of 125 µs: 375 µs, 625 µs ... 3.875 ms)
<b>PROFINET I device</b>	
Services	
PD/OP communication	Yes
S7 routing	Yes
S7 communication	Yes; with loadable FBs, max. configurable connections: 10, max. number of instances 32
Open IE communication	Yes; via TCP/IP, ISO on TCP, UDP
RT, supported	Yes
IRT supported	Yes
Shared Device	Yes
• Max. number of IO controllers for a Shared Device	2
Isochronous mode	No
PROFInergy, supported	With SFB 73 / 74 prepared for loadable PROFInergy standard FB for I device
Application transfer areas	Yes
I/O transfer areas	Yes
Transfer memory	
Inputs, max.	1440 bytes; per controller for a Shared Device
Outputs, max.	1440 bytes; per controller for a Shared Device
Submodules	
• Number, max.	64
• User data per submodule, max.	1024 bytes
<b>2nd interface</b>	
Port designation	X2; on the DP master module
Type of interface	RS 485, integrated interface on the DP master module
Physics	RS 485
Isolated	Yes
Max. interface power supply (15 V DC to 30 V)	No
Connection	9-pin sub-D socket
<b>Functionality</b>	
MPI	No
DP master	Yes

<b>Technical specifications</b>	
DP slave	No
PROFINET IO controller	No
PROFINET IO device	No
PROFINET CBA	No
Open IE communication	No
Web server	No
Point-to-point link	No
<b>DP master</b>	
Services	
PD/OP communication	Yes
Routing	Yes
Data set routing	Yes; (to field devices on the PROFIBUS DP)
Global data communication	
• Supported	No
S7 communication	
As server	Yes (one-sided configured connection)
As client	No
Transmission rate, max.	Up to 12 Mbaud
Support for constant bus cycle time	Yes
Isochronous mode	No
Enable/disable DP slaves	Yes
• Max. number of DP slaves that can be enabled / disabled simultaneously	8
SYNC/FREEZE	Yes
Direct data exchange	Yes
DPV1	Yes
Number of DP slaves, max.	32
Address area	
• Inputs, max.	2048 bytes
• Outputs, max.	2048 bytes
User data per DP slave	
• Inputs, max.	244 bytes
• Outputs, max.	244 bytes
<b>Programming</b>	
Programming language	STEP 7 V5.5 and higher
• LAD	Yes
• FBD	Yes
• STL	Yes
• SCL	Yes
• CFC	Yes
• GRAPH	Yes



Technical specifications	
• HiGraph	Yes
Instruction set	See instruction list
Nesting levels	8
System functions (SFC)	See instruction list
System function blocks (SFB)	See instruction list
User program protection / password protection	Yes
Encryption of blocks	Yes; with S7 Block Privacy
Mounting dimensions W x H x D (mm)	120 x 119.5 x 75
Weight	ca. 320 g
Voltages, currents, electrical potentials	
Rated supply voltage for the electronic components 1L+	24 VDC
• Permissible range	20.4 V to 28.8 V
• Reverse polarity protection	Yes; against destruction
• Short-circuit protection	Yes
• Power failure buffering	5 ms
Current consumption from rated supply voltage 1L+	
• IM 151-8 PN/DP CPU	Typ. 352 mA at 20 V; 294 mA at 24 V; 246 mA at 29 V
• IM151-8 PN/DP CPU + DP master module	Typ. 426 mA at 20 V; 355 mA at 24 V; 296 mA at 29 V
• Power supply for the ET 200S backplane bus	Max. 700 mA
Inrush current	Typically 1.8 A
$I^2t$	Typically 0.13 A <sup>2</sup> s
External fusing of power supply lines (recommended)	
• Electronic / encoder supply 1L+	24 VDC / 16 A circuit-breaker with type B or C tripping characteristic <b>Note:</b> A 24 VDC/16A circuit-breaker with type B tripping characteristic trips before the equipment fuse is tripped. A 24 VDC/16A circuit-breaker with type C tripping characteristic trips after the equipment fuse is tripped.
Power loss	Typically 5.5 W
Insulation tested with	500 VDC
Galvanic isolation	
• between the backplane bus and supply voltages 1L+	No
• between PROFIBUS / PROFINET and power supplies 1L+	Yes

Technical specifications	
• between the electronics and supply voltage 1L+	No
Maximum potential difference	75 VDC, 60 VAC
Status, interrupts, diagnostics	
Interrupts	Yes
Diagnostics function	Yes
Group errors	Red "SF" LED
Bus monitoring PROFINET	Red "BF-PN" LED
Maintenance information	Yellow "MT" LED
Monitoring of the supply voltage for the electronic components 1L+	Green LED "ON"
Existing connection to PROFINET	Green LED "P1 - LINK", "P2 - LINK" and "P3 - LINK"

## 12.3 DP master module

### 12.3.1 Technical specifications - DP master module

Table 12- 2 Technical specifications of the DP master module

Technical specifications	
Removal	
DP master module	
• Position	At the right alongside IM 151-8 PN/DP CPU
• Number for each IM 151-8 PN/DP CPU	1
Dimensions	
Mounting dimensions W x H x D (mm)	35 x 119.5 x 75
Weight	approx. 100 g
Status, interrupts, diagnostics	
PROFIBUS DP bus monitoring	Red "BF" LED

## Appendix

### A.1 Order numbers

#### A.1.1 Module order numbers

##### IM 151-8 PN/DP CPU interface module

Table A- 1 IM 151-8 PN/DP CPU order numbers

Designation	Order number
IM 151-8 PN/DP CPU interface module with terminating module, 1 unit	6ES7151-8AB01-0AB0
* The SIMATIC Micro Memory Card is not supplied as standard.	

##### DP master module

Table A- 2 DP master module order numbers

Designation	Order number
DP master module, 1 unit	6ES7138-4HA00-0AB0

## A.1.2 Order numbers of accessories

## IM 151-8 PN/DP CPU interface module accessories

Table A- 3 IM 151-8 PN/DP CPU accessories order numbers

Designation	Order number
SIMATIC Micro Memory Card 64k	6ES7953-8LF30-0AA0
SIMATIC Micro Memory Card 128k	6ES7953-8LG30-0AA0
SIMATIC Micro Memory Card 512k	6ES7953-8LJ30-0AA0
SIMATIC Micro Memory Card 2M	6ES7953-8LL30-0AA0
SIMATIC Micro Memory Card 4M	6ES7953-8LM30-0AA0
SIMATIC Micro Memory Card 8M (suitable for an FW update)	6ES7953-8LP30-0AA0
Label sheets DIN A4, 10 units	
• beige	6ES7193-4BA00-0AA0
• Yellow	6ES7193-4BB00-0AA0
• red	6ES7193-4BD00-0AA0
• petrol	6ES7193-4BH00-0AA0

## Connectors and cables

Table A- 4 Connectors and cables order numbers

Designation	Order number
<b>PROFINET</b>	
PROFINET RJ45 connector with FastConnect connection system, 90° cable outlet	
• 1 per pack, 1 pack	6GK1901-1BB20-2AA0
• 10 per pack, 1 pack	6GK1901-1BB20-2AB0
PROFINET FC cable Sold by meter, min. quantity 20 m Delivery unit max. 1000 m, 1 m	
• FC TP standard cable	6XV1840-2AH10
• FC TP trailing cable (for cable carriers)	6XV1840-3AH10
• FC TP marine cable	6XV1840-4AH10
PROFINET FastConnect stripping tool	6GK1901-1GA00
<b>PROFIBUS</b>	
PROFINET bus connector (12 Mbit/s) with FastConnect connection system, 90° cable outlet	
• without PD connection socket	6ES7972-0BA50-0XA0
• with PD connection socket	6ES7972-0BB50-0XA0

Designation	Order number
PROFIBUS FC cable Sold by meter, min. ordering quantity 20 m Delivery unit max. 1000 m, 1 m	
• FC Standard Cable	6XV1830-0EH10
• FC Trailing Cable (for cable carriers)	6XV1830-3EH10
• FC Food Cable (PE sheath)	6XV1830-0GH10
• FC Food Cable (PUR sheath)	6XV1830-0JH10
PROFIBUS FastConnect stripping tool	6GK1905-6AA00

## A.2 Dimension drawings

### A.2.1 IM 151-8 PN/DP CPU interface module

#### IM 151-8 PN/DP CPU interface module

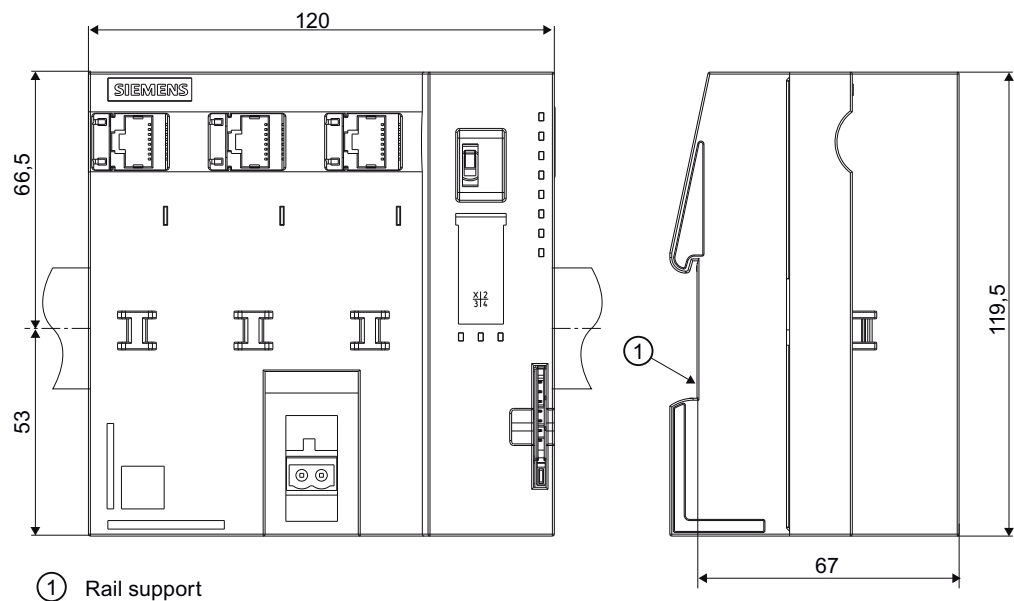
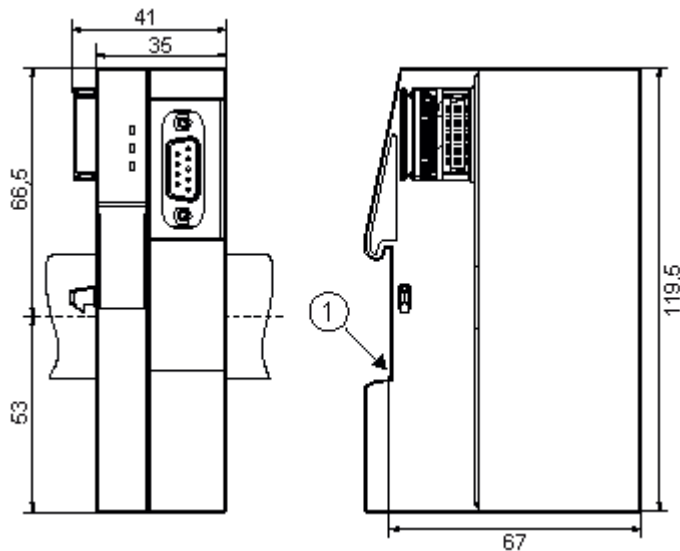

Figure A-1 IM 151-8 PN/DP CPU interface module dimensional diagram

## A.2.2 DP master module

### DP master module



① Rail support

Figure A-2 DP master module dimensional diagram

## A.3 Cycle and response times

### A.3.1 Overview

#### Overview

This section contains detailed information about the following topics:

- Cycle time
- Response time
- Interrupt response time

#### Reference: Cycle time

You can view the cycle time of your user program on the programming device. For additional information, refer to the *STEP 7 Online Help* or to the *Configuring Hardware and Connections in STEP 7* manual.

## Reference: Execution time

Execution times can be found in the *S7-300 Instruction List*. The instruction list contains the execution times in table form for all

- *STEP 7* instructions that can be processed by the IM 151-8 PN/DP CPU interface module
- SFCs / SFBs integrated in the IM 151-8 PN/DP CPU interface module,
- The IEC functions that can be called in *STEP 7*.

## A.3.2 Cycle time

### A.3.2.1 Overview: Cycle time

#### Introduction

This section explains what we mean by the term "cycle time", what it consists of, and how you can calculate it.

#### Meaning of the term cycle time

The cycle time represents the time that an operating system needs for one program pass, i.e. one OB 1 cycle, including all program sections and system activities interrupting this cycle. This time is monitored.

#### Time slice model

Cyclic program processing, and therefore user program execution, is based on time shares. To clarify these processes, let us assume that every time share has a length of precisely 1 ms.

#### Process image

During cyclic program processing, the IM 151-8 PN/DP CPU interface module requires a consistent image of the process signal. To ensure this, the process signals are read / written prior to program execution. The IM 151-8 PN/DP CPU interface module then does not address input (I) and output (Q) operand areas directly at the I/O modules, but rather accesses the system memory area containing the I/O process image.

### Sequence of cyclic program processing

The table and figure below show the phases in cyclic program processing.

Table A- 5 Cyclic program processing

Step	Sequence
1	The operating system initiates cycle time monitoring.
2	The IM 151-8 PN/DP CPU interface module writes the values from the process output image to the output modules.
3	The IM 151-8 PN/DP CPU interface module reads the status at the inputs of the input modules and then updates the process input image.
4	The IM 151-8 PN/DP CPU interface module processes the user program in time slices and executes the operations specified in the program.
5	At the end of a cycle, the operating system executes queued tasks, for example, loading and deleting blocks.
6	The IM 151-8 PN/DP CPU interface module then returns to the start of the cycle, and restarts cycle time monitoring.

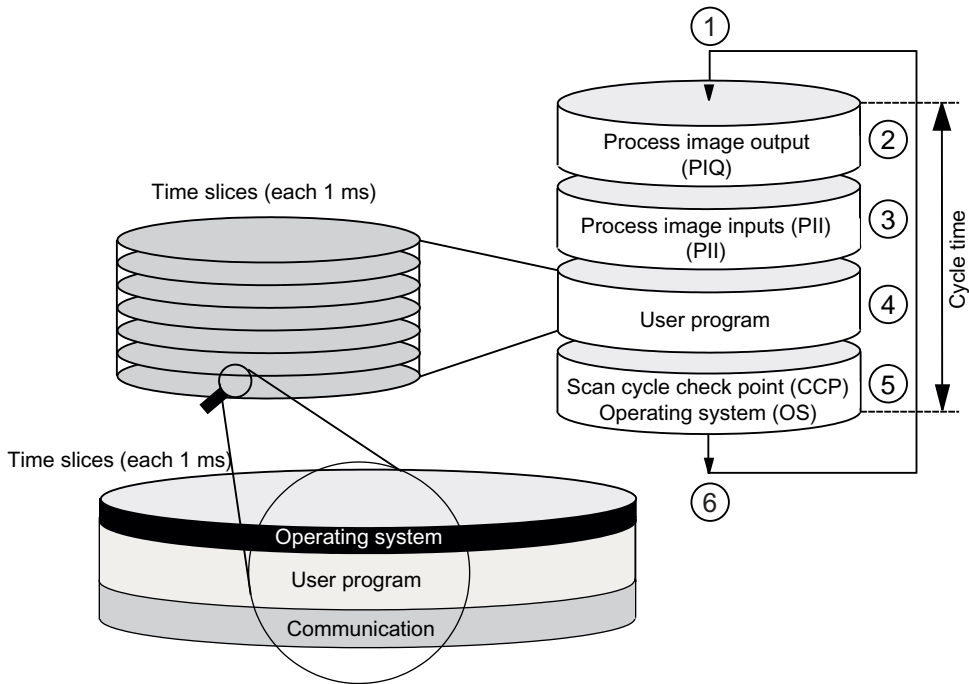

- PIQ: Process image of outputs
- PII: Process image of inputs
- CCP: Cycle control point
- OS: Operating system

In contrast to S7-400 CPUs, the IM 151-8 PN/DP CPU interface module only accesses data with an OP / TP (monitor and modify functions) at the cycle control point (for data consistency, see *Technical specifications*). Processing of the user program is not interrupted by the monitor and modify functions.



## Extending the cycle time

Always make allowances for the extension of the cycle time of a user program due to:

- Time-based interrupt processing
- Process interrupt processing
- Diagnostics and error processing
- Processing isochronic interrupts
- Communication with programming devices (PGs), operator panels (OPs) and via connected CPs (e.g. Ethernet or PROFIBUS DP)
- Testing and commissioning such as, e.g. status/controlling of variables or block status functions.
- Transfer and deletion of blocks, compressing user program memory
- Write/read access to the SIMATIC Micro Memory Card using SFC 82 to 84 in the user program
- S7 communication via the PROFINET interface.
- PROFINET CBA communication via the PROFINET interface (system load, SFC call, updating at the cycle control point)
- PROFINET IO communication via PROFINET interface (system load)

### A.3.2.2 Calculating the cycle time

#### Introduction

The cycle time is derived from the sum of the following influencing factors.

#### Process image update

The table below shows the times that an IM 151-8 PN/DP CPU interface module needs to update the process image (process image transfer time). The specified times may be extended as a result of interrupts or IM 151-8 PN/DP CPU interface module communication. The process image transfer time is calculated as follows:

Table A- 6 Formula for calculating the typical transfer time for the process image (PI)

<b>The transfer time of the process image is calculated as follows:</b>	
Base load K	+ Number of bytes in the PI for ET 200S I/Os (A) + Number of words in the PI via PROFINET (P) + Number of words in the PI via PROFIBUS DP (D) <b>= Transfer time for the process image</b>

Table A- 7 Data for calculating the process image (PI) transfer time

Constant	Components	IM 151-8 PN/DP CPU
C	Base load	140 µs
A	per byte in the PO for centralized ET 200S I/Os	60 µs
P (PROFINET only)	per WORD in the PROFINET area for the integrated PROFINET interface	0.5 µs
D (PROFIBUS DP only)	per word in the DP area for the DP interface integrated in the DP master	0.5 µs

#### Extending the user program processing time

In addition to actually working through the user program, your IM 151-8 PN/DP CPU interface module's operating system also runs a number of processes in parallel, such as timer management for the core operating system. These processes extend the processing time of the user program by up to 10%.

### Operating system processing time at the scan cycle check point

The table below shows the operating system processing time at the cycle control point of the IM 151-8 PN/DP CPU interface module. This time applies without:

- Testing and commissioning routines, e.g. status/controlling of variables or block status functions
- Transfer and deletion of blocks, compressing user program memory
- Communication
- Writing, reading of the SIMATIC Micro Memory Card with SFC 82 to 84

Table A- 8 Typical operating system processing time at the scan cycle check point

Interface module	Cycle control at the scan cycle check point (CCP)
IM 151-8 PN/DP CPU	150 $\mu$ s

### Extension of the cycle time as a result of nested interrupts

Enabled interrupts also extend cycle time. Details are found in the table below.

Table A- 9 Typical extended cycle time due to nested interrupts

Interrupt type	Process interrupt	Diagnostic interrupt	Time-of-day interrupt	Delay interrupt	Cyclic interrupt
IM 151-8 PN/DP CPU	200 $\mu$ s	250 $\mu$ s	300 $\mu$ s	180 $\mu$ s	160 $\mu$ s

The program runtime at interrupt level must be added to this time extension.

### Extension of the cycle time due to error

Table A- 10 Typical cycle time extension as a result of errors

Type of error	Programming errors	I/O access errors
IM 151-8 PN/DP CPU	120 $\mu$ s	130 $\mu$ s

You have to add the program execution time of the interrupt OB to this increase. The times required for multiple nested interrupt/error OBs are added accordingly.

### A.3.2.3 Communication load

#### Configured communication load for PG/OP communication, S7 communication and PROFINET CBA

The CPU operating system continuously provides a specified percentage of total CPU processing performance (time slice technology) for communication tasks. Processing performance not required for communication is made available to other processes.

In the hardware configuration you can specify a communication load value between 5% and 50%. The default value is 20%.

The extension of the cycle time is dependent on the communication loading and can fluctuate.

You can use the following formula for calculating the maximum cycle time extension factor:

$$100 / (100 - \text{configured communication load in \%})$$

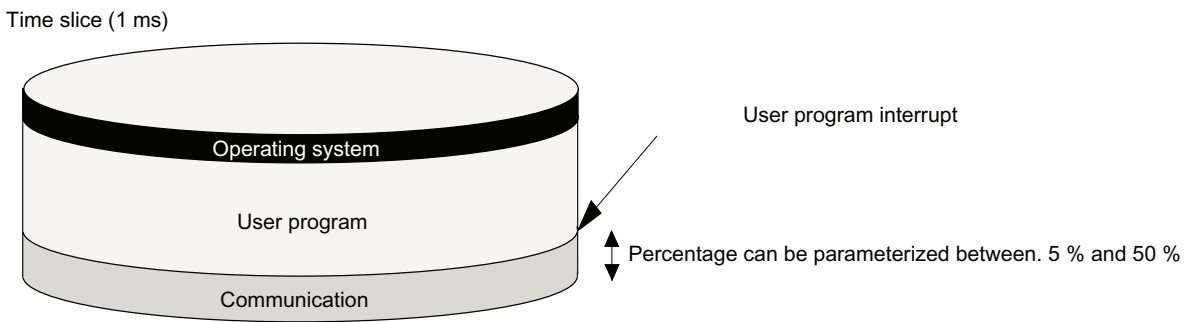

#### Example: 20% communication load

In your hardware configuration, you have specified a communication load of 20%. The calculated cycle time is 10 ms. Using the above formula, the cycle time is extended by the factor 1.25.

#### Example: 50% communication load

In your hardware configuration, you have specified a communication load of 50%. The calculated cycle time is 10 ms. Using the above formula, the cycle time is extended by the factor 2.

### Dependency of actual cycle time on the communication load

The figure below describes the non-linear dependency of the actual cycle time on the communication load. In our example we have chosen a cycle time of 10 ms.

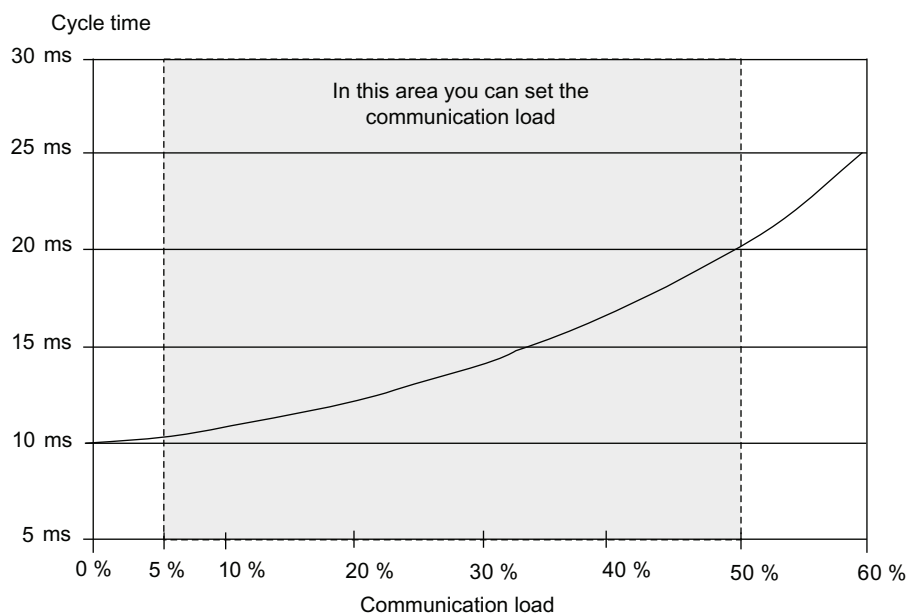

### Influence on the actual cycle time

From the statistical viewpoint, asynchronous events such as interrupts occur more frequently within the OB1 cycle when the cycle time is extended as a result of communication load. This further extends the OB1 cycle. This extension depends on the number of events that occur per OB1 cycle and the time required to process these events.

---

#### Note

Change the value of the "communication load" parameter to check the effects on the cycle time during system runtime. You must consider the communication load when setting the maximum cycle time, otherwise time errors may occur.

---

### Tips

- Use the default setting whenever possible.
- Increase this value only if the CPU is used primarily for communication and if the user program is not time critical.
- In all other situations you should only reduce this value.

### A.3.2.4 Cycle time extension as a result of testing and commissioning functions

#### Runtimes

The runtimes of the testing and commissioning functions are operating system runtimes, so they are the same for every CPU. How the cycle time is extended as a result of active testing and commissioning functions is shown in the table below.

Table A- 11 Cycle time extension as a result of test and commissioning functions

Function	IM 151-8 PN/DP CPU
Status variable	Negligible
Control variable	Negligible
Status block	Typ. 3 $\mu$ s for each monitored line + 3 x runtime of monitored block  The monitoring of large blocks and the monitoring of loops can lead to a significant increase in the cycle time.

#### Setting process and test mode in the LAD/FBD/STL editor

Switching between process and test mode is carried out directly in the LAD/FBD/STL editor in the "Test/Mode" menu.

Loops in the test and process mode are handled differently in the Status block.

- **Process mode:** First loop iteration is displayed
- **Test mode:** Last loop iteration is displayed. Leads to a significant cycle time increase for many loop iterations.

In terms of function, there is also no difference between process mode and test mode.

---

#### Note

It is also possible to set breakpoints in test mode.

---

#### Reference

Information on the cycle extension due to Component Based Automation (CBA) can be found in the respective section of the S7-300, CPU 31xC and CPU 31x, Technical Data (<http://support.automation.siemens.com/WW/view/en/12996906>) manual.

## A.3.3 Response time

### A.3.3.1 Overview: Response time

#### Definition of response time

The response time is the time between the detection of an input signal and the change of a linked output signal.

#### Fluctuation width

The physical response time lies between the shortest and the longest response time. You must always reckon with the longest response time when configuring your system.

The shortest and longest response times are shown below, to give you an idea of the fluctuation width of the response time.

#### Factors

The response time depends on the cycle time and following factors:

- Delay in the I/O module inputs and outputs
- Additional send cycles for PROFINET IO
- Additional DP cycle times on PROFIBUS DP
- Execution in the user program

#### Reference

The delay times are described in the technical data for the I/O modules in the ET 200S Distributed I/O Device (<http://support.automation.siemens.com/WW/view/en/10805258/133300>) manual.

#### Update Time for PROFINET IO

If you configured your PROFINET IO system in *STEP 7*, *STEP 7* calculates the send cycle for PROFINET IO. You can then view the PROFINET IO send cycles on your PG.

### DP cycle times in the PROFIBUS DP network

If you configured your PROFIBUS DP master system with *STEP 7*, then *STEP 7* will calculate the typical DP cycle time that must be expected. You can then view the DP cycle time of your configuration on the programming device.

The figure below gives you an overview of the DP cycle time. In this example, let us assume that the data of each DP slave has an average length of 4 bytes.

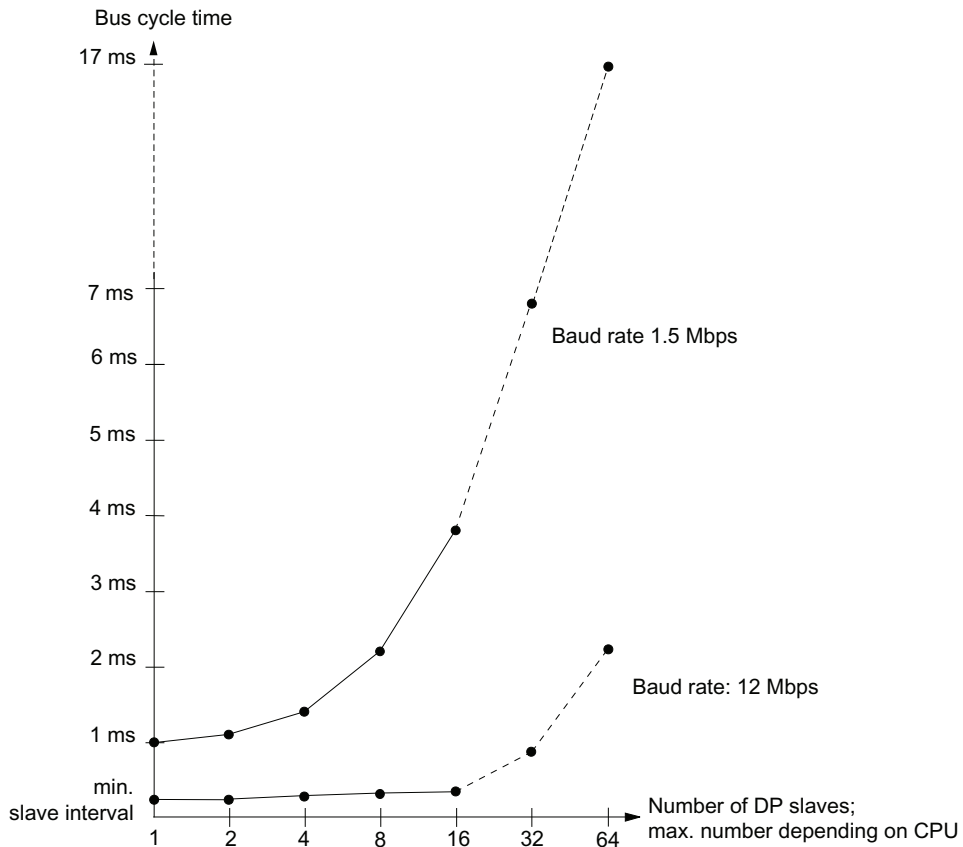

With multi-master operation on a PROFIBUS-DP network, you must make allowances for the DP cycle time at each master. That is, you will have to calculate the times for each master separately and then add up the results.



### A.3.3.2 Shortest response time

#### Conditions for the shortest response time

The figure below shows the conditions under which the shortest response time is reached.

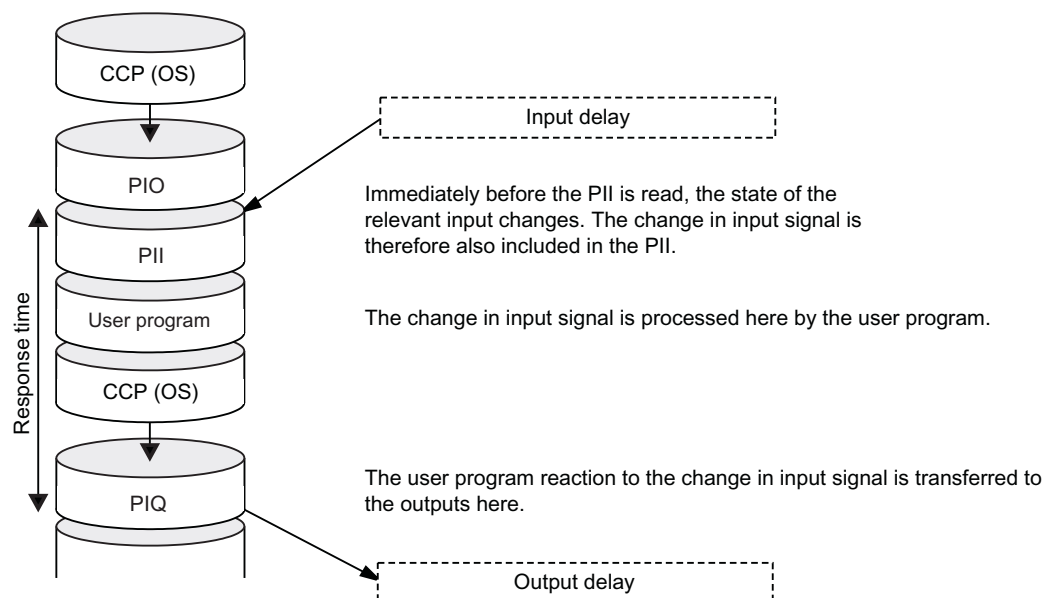

#### Calculation

The (shortest) response time is the sum of:

Table A- 12 Formula: Shortest response time

- 1 x process image transfer time for the inputs
- + 1 x process image transfer time for the outputs
- + 1 x program processing time
- + 1 x operating system processing time at the SCC
- + Delay in the inputs and outputs
- = **Shortest response time**

The result is equivalent to the sum of the cycle time plus the I/O delay times.

#### See also

Overview: Response time (Page 255)

### A.3.3.3 Longest response time

#### Conditions for the longest response time

The figure below shows the conditions under which the longest response time is reached.

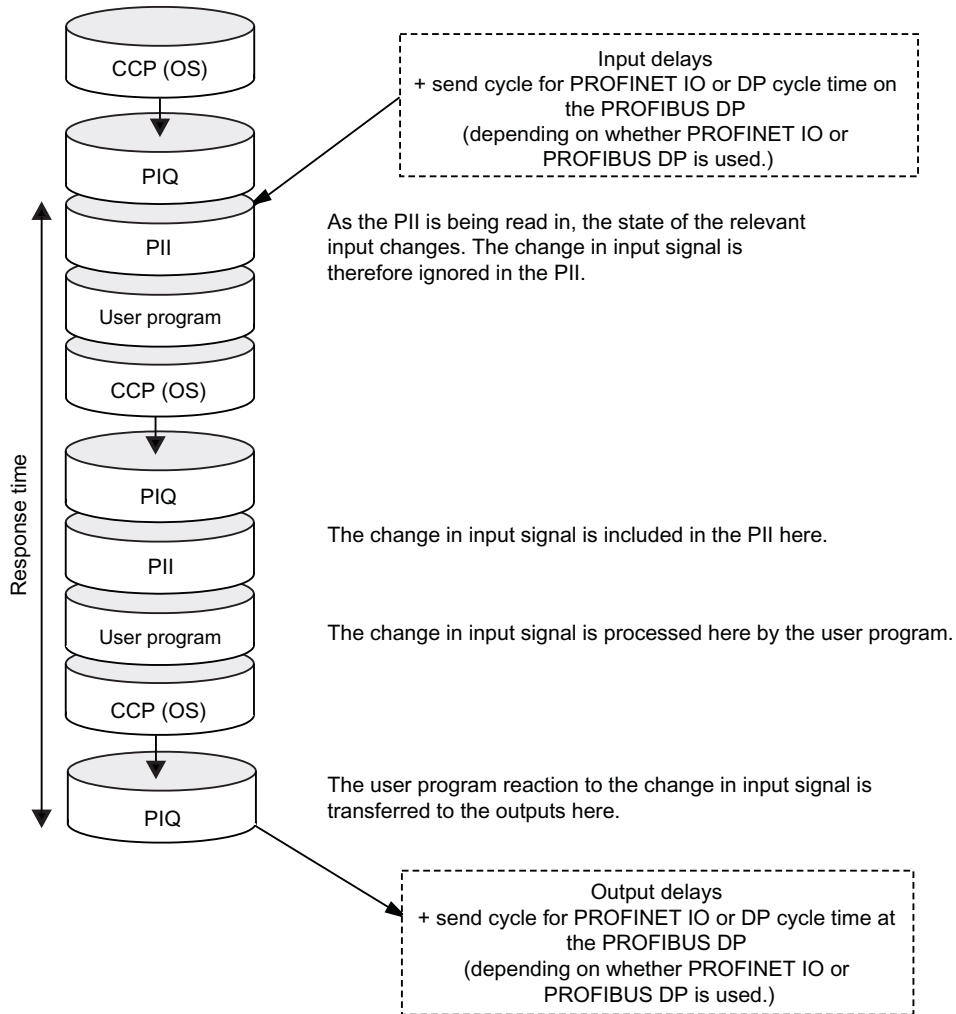

## Calculation

The (longest) response time is the sum of:

Table A- 13 Formula: Longest response time

	2 x process image transfer time for the inputs
+	2 x process image transfer time for the outputs
+	2 x program processing time
+	2 x operating system processing time
+	2 x PROFINET IO update time (only if PROFINET IO is used)
+	2 x DP cycle time on PROFIBUS DP (only if PROFIBUS DP is used)
+	Delay in the inputs and outputs
=	<b>Longest response time</b>

Equivalent to the sum of 2 x the cycle time + I/O delay time + 2 x the PROFINET IO scan cycle or 2 x the DP cycle time on PROFIBUS DP.

## See also

Overview: Response time (Page 255)

## A.3.4 Interrupt response time

### A.3.4.1 Overview: Interrupt response time

#### Definition of interrupt response time

The interrupt response time is the time that elapses between the first occurrence of an interrupt signal and the call of the first interrupt OB instruction. Generally valid: Higher-priority interrupts take priority. This means that the interrupt response time is increased by the program processing time of the higher-priority interrupt OBs and the interrupt OBs of equal priority which have not yet been executed (queued).

## Process interrupt and diagnostic interrupt response times of the IM 151-8 PN/DP CPU interface module

Table A- 14 Process interrupt and diagnostic interrupt response times of the IM 151-8 PN/DP CPU interface module

Interrupt response times (without communication) for ...	Duration
Process alarm / diagnostic alarm	less than 10 ms

### Process interrupt processing

Process interrupt processing begins after process interrupt OB 40 is called. Higher-priority interrupts stop process interrupt processing. Direct I/O access is executed during runtime of the instruction. After process interrupt processing has terminated, cyclic program execution continues or further interrupt OBs of equal or lower priority are called and processed.

### See also

Overview (Page 246)

### A.3.4.2 Reproducibility of Time-Delay and Watchdog Interrupts

#### Definition of "reproducibility"

##### Time-delay interrupt:

The period that expires between the call of the first operation in the interrupt OB and the programmed time of interrupt.

##### Watchdog interrupt:

The fluctuation range of the interval between two successive calls, measured between the respective initial operations of the interrupt OB.

### Reproducibility

The following times apply for the IM151-8 PN/DP CPU:

- Time-delay interrupt: +/- 100  $\mu$ s
- Watchdog interrupt: +/- 100  $\mu$ s

These times only apply if the interrupt can actually be executed at this time and if it is not delayed, for example, by higher-priority interrupts or queued interrupts of equal priority.

## A.4 Additional documentation

The following documentation contains detailed information on specific topics. The appropriate areas of these operating instructions refer to this documentation.

You can find the documents together with the associated entry ID on the Internet.

Name of manual	Description
<b>Operating Instructions</b> ET 200S Distributed I/O System Entry ID: 1144348 <a href="http://support.automation.siemens.com/WW/view/en/1144348">http://support.automation.siemens.com/WW/view/en/1144348</a>	Application planning; assembling; wiring and assembly; commissioning; functions; alarm, error, and system messages; interface modules, COMPACT modules
<b>Manuals</b> <a href="http://support.automation.siemens.com/WW/view/en/10805258/133300">http://support.automation.siemens.com/WW/view/en/10805258/133300</a> for the ET 200S Distributed I/O System	Description of functions and technical specifications of the terminal modules, power modules, and digital and analog electronic modules
<b>System Manual</b> PROFINET system description Entry ID: 19292127 <a href="http://support.automation.siemens.com/WW/view/en/19292127">http://support.automation.siemens.com/WW/view/en/19292127</a>	Basic description of PROFINET: <ul style="list-style-type: none"> <li>• Network components</li> <li>• Data exchange and communication</li> <li>• PROFINET IO</li> <li>• Component-based automation</li> <li>• Application example of PROFINET IO and Component Based Automation</li> </ul>
<b>Programming Manual</b> From PROFIBUS DP to PROFINET IO Entry ID: 19289930 <a href="http://support.automation.siemens.com/WW/view/en/19289930">http://support.automation.siemens.com/WW/view/en/19289930</a>	Guideline for the migration from PROFIBUS DP to PROFINET I/O.
<b>Instructions List</b> CPU 312, CPU 314, CPU 315-2 DP, CPU 315-2 PN/DP, CPU 317-2 PN/DP, CPU 319-3 PN/DP, IM 151-8 PN/DP CPU, IM 154-8 PN/DP CPU Entry ID: 31977679 <a href="http://support.automation.siemens.com/WW/view/en/31977679">http://support.automation.siemens.com/WW/view/en/31977679</a>	<ul style="list-style-type: none"> <li>• List of the instruction set of the CPUs and their execution times.</li> <li>• List of the executable blocks (OBs/SFCs/SFBs) and their execution times.</li> </ul>
<b>Reference Manual</b> System software for S7-300/400 system and standard functions, Volume 1/2 Entry ID: 1214574 <a href="http://support.automation.siemens.com/WW/view/en/1214574">http://support.automation.siemens.com/WW/view/en/1214574</a>	Overview of objects included in the operating systems for S7-300 and S7-400 CPUs: <ul style="list-style-type: none"> <li>OBs</li> <li>SFCs</li> <li>SFBs</li> <li>IEC functions</li> <li>diagnostics data</li> <li>system status list (SSL)</li> <li>events</li> </ul> This manual is part of the <i>STEP 7</i> reference information. You can also find the description in the <i>Online Help for STEP 7</i> .

Name of manual	Description
<b>Manual</b> Programming with STEP 7 Entry ID: 18652056 <a href="http://support.automation.siemens.com/WW/view/en/18652056">http://support.automation.siemens.com/WW/view/en/18652056</a>	This manual provides an overview of programming with <i>STEP 7</i> .  This manual is part of the <i>STEP 7</i> basic information. You can also find the description in the <i>Online Help for STEP 7</i> .
<b>Manual</b> Configuring Hardware and Communication Connections with STEP 7 Entry ID: 18652631 <a href="http://support.automation.siemens.com/WW/view/en/18652631">http://support.automation.siemens.com/WW/view/en/18652631</a>	basics, configuration, saving, importing, exporting, networking, configuring connections, downloading
<b>Manual</b> CPU 31xC and CPU 31x, Technical specifications Entry ID: 12996906 <a href="http://support.automation.siemens.com/WW/view/en/12996906">http://support.automation.siemens.com/WW/view/en/12996906</a>	Description of: <ul style="list-style-type: none"> <li>• Operating and display elements</li> <li>• Communication</li> <li>• Memory concept</li> <li>• Cycle and response times</li> <li>• Technical data</li> </ul>
<b>Manual</b> SIMATIC NET: Twisted Pair and Fiber-Optic Networks Entry ID: 8763736 <a href="http://support.automation.siemens.com/WW/view/en/8763736">http://support.automation.siemens.com/WW/view/en/8763736</a>	Description of: Industrial Ethernet networks network configuration, components, <ul style="list-style-type: none"> <li>• Guidelines for setting up networked automation systems in buildings, etc.</li> </ul>
<b>Tutorial</b> Component Based Automation, Commissioning Systems Entry ID: 18403908 <a href="http://support.automation.siemens.com/WW/view/en/18403908">http://support.automation.siemens.com/WW/view/en/18403908</a>	Creating PROFINET components, commissioning systems
<b>Manual</b> Communication with SIMATIC Entry ID: 1254686 <a href="http://support.automation.siemens.com/WW/view/en/1254686">http://support.automation.siemens.com/WW/view/en/1254686</a>	Description of: Basics, services, networks, communication functions, connecting PDs/OPs, project design and configuration in <i>STEP 7</i>
<b>Manual</b> The Process Device Manager Entry ID: 21407212 <a href="http://support.automation.siemens.com/WW/view/en/21407212">http://support.automation.siemens.com/WW/view/en/21407212</a>	Starting <i>SIMATIC PDM</i> , configuring networks and devices, working with <i>SIMATIC PDM</i> , communication, diagnostics
<b>Manual</b> Diagnostic repeater for PROFIBUS DP Entry ID: 7915183 <a href="http://support.automation.siemens.com/WW/view/en/7915183">http://support.automation.siemens.com/WW/view/en/7915183</a>	product overview, functions, configuration possibilities, installation, wiring, commissioning, diagnostics

# Glossary

## Accumulator

Accumulators represent CPU register and are used as buffer memory for download, transfer, comparison, calculation and conversion operations.

*See also CPU*

## Address

An address is the identifier of a specific operand or operand area.  
Examples: Input I 12.1; Memory Word MW 25; Data Block DB 3.

## Analog modules

Analog modules convert analog process values (for example, temperature) into digital values that can be processed by the IM 151-8 PN/DP CPU interface module or convert digital values into analog manipulated variables.

## Application

→ *User program*

## Application

An application is a program that runs directly on the MS-DOS / Windows operating system. Applications on the programming device include, for example, the *STEP 7* basic package, S7-GRAPH and others.

## ASIC

ASIC is the acronym for Application Specific Integrated Circuits.

PROFINET ASICs are components with a wide range of functions for the development of your own devices. They implement the requirements of the PROFINET standard in a circuit and allow extremely high packing densities and performance.

Because PROFINET is an open standard, SIMATIC NET offers PROFINET ASICs for the development of your old devices under the name ERTEC .

## Automation system

An automation system is a programmable logic controller in the context of SIMATIC S7.

*See also Programmable Logic Controller*

### **Autonegotiation**

Configuration protocol in the Fast Ethernet. Before the actual data transfer the devices on the network agree a transfer mode that each participating device can master (100 Mbps or 10 Mbps, full-duplex or half-duplex)

### **Backplane bus**

Serial data bus used by the interface module to communicate with electronic modules and to supply power to these. The individual modules are interconnected by means of terminal modules.

### **Backup memory**

Backup memory ensures buffering of the memory areas of a CPU without backup battery. It backs up a configurable number of timers, counters, bit memory, data bytes and retentive timers, counters, bit memory and data bytes).

*See also CPU*

### **Baud rate**

Data transfer rate (in bps)

### **Bit memory**

Bit memory are part of the CPU's system memory. They store intermediate results of calculations. They can be accessed in bit, word or dword operations.

*See System memory*

### **Bus**

A bus is a communication medium connecting several nodes. Data can be transferred via serial or parallel circuits, that is, via electrical or fiber optic conductors .

### **Bus connector**

Physical connection between the bus node and the bus cable.

### **Bus node**

This is a device that can send, receive or amplify data via the bus. It can be a DP master, DP slave, RS 485 repeater, active star coupler etc.

### **Bus segment**

A bus segment is a self-contained section of a serial bus system. Bus segments are linked to one another using repeaters in PROFIBUS DP, for example.



**Changing IO devices during operation (changing partner ports)**

Functionality of a PROFINET device.

A PROFINET device that supports this function can communicate during operation with changing communication partners at the same port.

**Chassis ground**

Chassis ground includes all the interconnected inactive parts of equipment that must not carry a hazardous voltage even in the event of a fault.

**Clock memory**

Memory bit which can be used to generate clock pulses in the user program (1 memory byte).

---

**Note**

Make sure that the clock memory byte is not overwritten in the user program.

---

**Code block**

A SIMATIC S7 logic block contains elements of the *STEP 7* user program. (in contrast to a DB: this contains only data.)

*See also Data block*

**Component-based automation**

→ *PROFINET CBA*

**Compression**

The programming device online function "Compress" is used to rearrange all valid blocks in CPU RAM in one continuous area of user memory, starting at the lowest address. This eliminates fragmentation which occurs when blocks are deleted or edited.

**Configuration**

Assignment of modules to slots and (for example with electronic modules) addresses.

**Consistent data**

Data which are related in their contents and not to be separated are referred to as consistent data.

For example, the values of analog modules must always be handled as a whole, that is, the value of an analog module must not be corrupted as a result of read access at two different points of time.

## Counters

Counters are part of CPU system memory. The content of "Counter cells" can be modified by *STEP 7* instructions (for example, up/down count.)

*See also System memory*

## CPU

Central processing unit = CPU of the S7 automation system with a control and arithmetic unit, memory, operating system, and interface for programming device.

## Cycle time

The cycle time represents the time a CPU requires for one execution of the user program.

*See also User program*

*See also CPU*

## Cyclic interrupt

→ *Interrupt, cyclic interrupt*

## Data block

Data blocks (DB) are data areas in the user program which contain user data. There are shared data blocks which can be accessed by all code blocks, and instance data blocks which are assigned to a specific FB call.

## Data exchange broadcast

→ *Direct data exchange*

## Data exchange traffic

→ *Direct data exchange*

## Data set routing

Functionality of a module with several network connections.

Modules that support this function are able to pass on data of an engineering system (for example parameter data generated by SIMATIC PDM) from a subnetwork such as Ethernet to a field device at the PROFIBUS DP.

## Data, static

Static data can only be used within a function block. These data are saved in an instance data block that belongs to a function block. Data stored in an instance data block are retained until the next function block call.

**Data, temporary**

Temporary data is the local data of a block. It is stored in the L-stack when the block is executed. After the block has been processed, this data is no longer available.

**DCP**

DCP (**D**iscovery and **B**asic **C**onfiguration **P**rotocol). Enables the assignment of device parameters (such as IP addresses) using manufacturer-specific configuration tools/programming tools.

**Default router**

The default router is the router that is used when data must be forwarded to a partner located within the same subnet.

In *STEP 7*, the default router is called **Router**. *STEP 7* assigns a local IP address to the default router by default.

**Determinism**

→ *Real Time*

**Device**

Within the context of PROFINET, "device" is the generic term for:

- Automation systems
- Field devices (PLC, PC, for example)
- Active network components (for example, distributed I/O, valve terminals, drives)
- Hydraulic devices
- Pneumatic devices

The main characteristic of a device is its integration in PROFINET communication over Ethernet or PROFIBUS.

The following device types are distinguished based on their attachment to the bus:

- PROFINET devices
- PROFIBUS devices

**Device**

→ *PROFIBUS device*

**Device**

→ *PROFINET device*

## Device name

Because a fixed IP address is assigned to the device name, an IO device must have a device name in order to be addressed by an IO controller. With PROFINET, this procedure is used because names are easier to handle than complex IP addresses.

The assignment of a device name for a specific IO device can be compared with the setting of the PROFIBUS address for a DP slave.

In the state of delivery a IO device has no device name. The IO device can only be addressed by a IO controller after the device has been assigned a device name, for the transfer of configuration data (IP address and other data) in the startup phase or for the exchange of user data in cyclic operation, for example.

Alternatively the device name can be written directly to the SIMATIC Micro Memory Card (e.g. for the ET 200S IO device) in the programming device.

## Device replacement without removable media / PD

IO devices having this function can be replaced simply:

- A removable medium (such as Micro Memory Card) with stored device name is not required.
- The device name does not have to be assigned with the PD.
- If a replacement is necessary, an IO device already in operation has to be reset to the factory settings by using "Reset to factory setting".

The replaced IO device obtains the device name from the IO controller, not from the removable medium or from the programming device. For this purpose, the IO controller uses the configured topology and the neighbor relationships determined by the IO devices. The configured setpoint topology must agree with the actual topology.

## Diagnostic interrupt

Modules capable of diagnostics operations report detected system errors to the CPU by means of diagnostic interrupts.

*See also CPU*

## Diagnostics

→ *System diagnostics*

## Diagnostics buffer

The diagnostics buffer represents a buffered memory area in the CPU. It stores diagnostic events in the order of their occurrence.

## Direct data exchange

Direct data exchange is a special communication relationship between PROFIBUS DP nodes. The direct data exchange is characterized by PROFIBUS DP nodes which "listen" on the bus and know which data a DP slave returns to its DP master.

## Distributed I/O systems

I/O systems that are not integrated into the central controller, but rather at distributed locations a long distance from the CPU, such as:

- ET 200M, ET 200L, ET 200S, ET 200pro
- DP/AS-I Link
- S5-95U with PROFIBUS DP slave interface
- Further DP slaves supplied by Siemens or other vendors.

The distributed I/O systems are connected to the DP master via PROFIBUS DP.

## DP master

→ *Master*

## DP master

A master that complies with the IEC 61784-1:2002 Ed1 CP 3/1 standard is known as a DP master.

## DP slave

→ *Slave*

## DP slave

A slave running on the PROFIBUS using the PROFIBUS DP protocol in compliance with IEC 61784-1:2002 Ed1 CP 3/1 is known as a DP slave.

## DP Standard

Bus protocol of the ET 200 distributed I/O system to IEC 61784-1:2002 Ed1 CP 3/1.

## DPV1

The designation DPV1 means extension of the functionality of the acyclical services (to include new interrupts, for example) provided by the DP protocol. The DPV1 functionality is an integral part of the IEC 61784-1:2002 Ed1 CP 3/1 standard.

## Electrically isolated

Electrically isolated I/O modules are isolated from the reference potentials of the control and load circuits by means of an optocoupler, relay contact or transformer circuit, for example. I/O circuits may be connected to the same potential.

### Electronic modules

Electronic modules form the interface between the process and the automation system. There are

- digital input and output modules
- analog input and output modules
- Technology modules

### Equipotential bonding

Electrical connection (equipotential bonding conductor) that keeps electrical equipment and extraneous conductive objects to the same or almost the same potential in order to prevent disturbing or dangerous voltages between those objects.

### Error display

One of the possible reactions of the operating system to a runtime error is to output an error message. Further reactions: Error reaction in the user program, CPU in STOP.

*See also Runtime error*

*See also Error reaction*

### Error handling via OB

After the operating system has detected a specific error (e.g. an access error with *STEP 7*), it calls a dedicated organization block (error OB) in which the subsequent behavior of the CPU can be defined.

### Error response

Reaction to a runtime error. Reactions of the operating system: It sets the automation system to STOP, indicates the error, or calls an OB in which the user can program a reaction.

*See also Runtime error*

### ERTEC

→ *ASIC*

## ET 200

The ET 200 distributed I/O system with PROFIBUS DP or PROFINET IO allows the connection of distributed I/Os to a CPU via a DP master or IO controller. ET 200 is characterized by high-speed reaction times, because of a minimum data transfer volume (bytes.)

The ET 200 is based on IEC 61784-1:2002 Ed1 CP 3/1.d standard.

The ET 200 works on the master / slave principle or controller / device principle. The DP masters are, for example, the IM 308-C master connection or the IM 151-8 PN/DP CPU interface module with DP master module. An IO controller could be, for example, the IM 151-8 PN/DP CPU interface module.

DP slaves / IO devices could be the distributed I/Os ET 200M, ET 200L, ET 200S, ET 200pro or DP slaves / IO devices from Siemens or other vendors.

## External lightning protection

External plant components at which galvanic coupling of lightning surges is excluded. Corresponds with lightning protection zone 0<sub>A</sub> and 0<sub>B</sub>.

## Fast Ethernet

Fast Ethernet describes the standard for transferring data with 100 Mbits. Fast Ethernet uses the 100 Base-T standard.

## FB

→ *Function block*

## FC

→ *Function*

## Flash EPROM

FEEPROMs can retain data in the event of power loss, same as electrically erasable EEPROMs. However, they can be erased within a considerably shorter time (FEEPROM = Flash Erasable Programmable Read Only Memory). They are used on SIMATIC Micro memory cards.

## FORCE

The Force function can be used to assign the variables of a user program or CPU (also: inputs and outputs) constant values.

Note in this connection also the restrictions in section *Overview: Debugging functions* in section *Debugging functions, diagnostics and troubleshooting*.

## **FREEZE**

Control command a DP master may broadcast to a group of DP slaves.

When it receives a FREEZE command, the slave freezes its current input status and outputs its data cyclically to the DP master.

The DP slave freezes its input status again after each new FREEZE command.

The DP slave does not resume the transfer input data to the DP master until the DP master has sent the UNFREEZE control command.

## **Function**

According to IEC 1131-3, a function (FC) is a code block without static data. A function allows transfer of parameters in user program. Functions are therefore suitable for programming frequently occurring complex functions, e.g. calculations.

## **Function block**

According to IEC 1131-3, a function block (FB) is a code block with static data. An FB allows the user program to pass parameters. Function blocks are therefore suitable for programming complex functions, e.g., closed-loop controls, mode selections, which are repeated frequently.

## **Functional ground**

Grounding which has the sole purpose of safeguarding the intended function of electrical equipment. With functional grounding you short-circuit interference voltage which would otherwise have an unacceptable impact on equipment.

## **Ground**

The conductive earth whose electrical potential can be set equal to zero at any point.

Ground potential may be different from zero in the area of grounding electrodes. The term reference ground is frequently used to describe this situation.

## **Ground-free**

Having no direct electrical connection to ground

## **Grounding**

Grounding means, to connect an electrically conductive component via an equipotential grounding system to a grounding electrode (one or more conductive components with highly conductive contact to earth).



## GSD file

The properties of a PROFINET device are described in a GSD file (General Station Description) that contains all the information required for configuration.

As with PROFIBUS, you can link a PROFINET device in *STEP 7* by means of a GSD file.

In the case of the PROFINET IO the GSD file is in XML format. The structure of the GSD file is compliant with ISO 15734, which is the world-wide standard for device descriptions.

For PROFIBUS, the GSD file is in ASCII format (according to IEC 61784-1:2002 Ed1 CP 3/1).

## Hot-swapping

The removal and insertion of modules during the operation of the ET 200S.

## I-Device

The "I-Device" (intelligent IO device) functionality of a CPU permits the exchange of data with an IO controller, thereby allowing the CPU to be used as an intelligent pre-processing unit for subprocesses. For this purpose, the I device is linked in the role of an IO device to a "higher level" IO controller.

The pre-processing is performed by the user program in the CPU with the I device functionality. The centralized or decentralized (PROFINET IO or PROFIBUS DP) process values are pre-processed by the user program and delivered to a higher level station by a PROFINET IO device interface of the CPU.

## IM

Interface module: The interface module combines the ET 200S with the DP master or the IO controller and prepares the data for the electronic modules.

In an ET 200S with IM151-8 PN/DP CPU, the IM 151-8 PN/DP CPU interface module is itself the

- IO controller or
- DP master (together with the DP master module).

## Industrial Ethernet

→ *Fast Ethernet*

## Industrial Ethernet

Industrial Ethernet (formerly SINEC H1) is a technology that allows data to be transmitted free of interference in an industrial environment.

Standard Ethernet components can be used since the PROFINET is an open system. However, we recommend setting up PROFINET as Industrial Ethernet.

## Industrial Wireless LAN

In addition to data communication, Industrial Wireless LAN from SIMATIC NET with the standard IEEE 802.11, offers a multitude of extensions (I-Features) that are of great benefit to industrial users. IWLAN is particularly suited for complex industrial applications with requirement for reliable radio communication, owing to:

- Automatic roaming if connection to Industrial Ethernet is interrupted (Rapid Roaming)
- Cost savings generated by using a single wireless network for secure operation of a process with both process-critical data (alarm message, for example) and non-critical communication (service and diagnostics, for example)
- Cost-effective connection to devices in remote, difficult-to-access environments

## Instance data block

The *STEP 7* user program assigns an automatically-generated DB to every call of a function block. The instance data block stores the values of input, output and in/out parameters, as well as local block data.

## Internal lightning protection

Shielding of buildings, rooms or devices Corresponds with lightning protection zone 1, 2 or 3.

## Interrupt

The operating system of an S7 CPU can distinguish between different priority classes that control how the user program is executed. These priority classes include interrupts, e.g. process interrupts. When an interrupt is triggered, the operating system automatically calls an assigned OB. In this OB the user can program the desired response (e.g. in an FB).

*See also Operating system*

## Interrupt, cyclic interrupt

A cyclic interrupt is generated periodically by the CPU in a configurable time pattern. A corresponding OB will be processed.

*See also Organization Block*

## Interrupt, delay

The delay interrupt belongs to one of the priority classes in SIMATIC S7 program processing. It is generated on expiration of a time started in the user program. A corresponding OB will be processed.

## Interrupt, delay

→ *Interrupt, delay*

**Interrupt, diagnostic**

→ *Diagnostic interrupt*

**Interrupt, process**

→ *Process interrupt*

**Interrupt, status**

A status interrupt can be generated by a DPV1 slave or a PNIO device respectively. At the DPV1 master or the PNIO controller respectively the receipt of the interrupt causes the OB 55 to be called.

For detailed information on OB 55, refer to the Reference Manual *System Software for S7-300/400*.

**Interrupt, time-of-day**

The time-of-day interrupt is one of the priority classes in SIMATIC S7 program processing. It is generated at a specific date (or daily) and time-of-day (e.g. 9:50 or hourly, or every minute). A corresponding OB will be processed.

**Interrupt, update**

An update interrupt can be generated by a DPV1 slave or a PNIO device respectively. At the DPV1 master or the PNIO controller respectively the receipt of the interrupt causes the OB 56 to be called.

For detailed information on OB 56, refer to the Reference Manual *System Software for S7-300/400*.

**Interrupt, vendor-specific**

A manufacturer-specific interrupt can be generated by a DPV1 slave or a PNIO device respectively. At the DPV1 master or the PNIO controller respectively the receipt of the interrupt causes the OB 57 to be called.

For detailed information on OB 57, refer to the Reference Manual *System Software for S7-300/400*.

**IO controller**

→ *PROFINET IO Controller*

**IO controller**

→ *PROFINET IO Device*

**IO controller**

→ *PROFINET IO Supervisor*

**IO controller**

→ *PROFINET IO System*

**IO device**

→ *PROFINET IO Controller*

**IO device**

→ *PROFINET IO Device*

**IO device**

→ *PROFINET IO Supervisor*

**IO device**

→ *PROFINET IO System*

**IO supervisor**

→ *PROFINET IO Controller*

**IO supervisor**

→ *PROFINET IO Device*

**IO supervisor**

→ *PROFINET IO Supervisor*

**IO supervisor**

→ *PROFINET IO System*

**IO system**

→ *PROFINET IO System*

## IP address

To allow a PROFINET device to be addressed as a node on Industrial Ethernet, this device also requires an IP address that is unique within the network. The IP address is made up of 4 decimal numbers with a range of values from 0 through 255. The decimal numbers are separated by periods.

The IP address is made up of:

- The address of the (subnet) network
- The address of the node (generally called the host or network node)

## IRT

→ *Isochronous Real Time communication*

## Isochronous mode

Process data, transfer cycle via PROFIBUS DP or PROFINET IO and user program are synchronized with each other to achieve the highest deterministic. The input and output data of distributed I/O devices in the system are detected and output simultaneously. The constant bus cycle times of the PROFIBUS DP cycle/PROFINET IO cycle are the clock generator for this.

## Isochronous Real Time communication

Synchronized transmission procedure for the cyclic exchange of IRT / IO data between PROFINET devices.

A reserved bandwidth within the send clock is available for the IRT / IO data. The reserved bandwidth ensures that the IRT IO data can be transmitted at reserved, synchronized intervals whilst remaining uninfluenced even by other greater network loads (e.g. TCP / IP communication or additional real time communication).

## LAN

Local area network. Interconnects computers within an enterprise. The LAN therefore has a limited geographical span and is solely available to a company or institution.

## LLDP

LLDP (Link Layer Discovery Protocol) is a protocol that is used to detect the closest neighbors. It enables a device to send information about itself and to save information received from neighboring devices in the LLDP MIB. This information can be looked up via the SNMP. This information allows a network management system to determine the network topology.

## Load memory

The load memory contains objects generated by the programming device. For the IM 151-8 PN/DP CPU interface module, it takes the form of a plug-in SIMATIC Micro Memory Card with various memory sizes. There must be a SIMATIC Micro Memory Card inserted in order to use the IM 151-8 PN/DP CPU interface module.

### Load power supply

Power supply for the load voltage for the power modules

### Local data

→ *Data, temporary*

### MAC Address

Every PROFINET device is assigned a worldwide unique device identification before it leaves the factory. This 6-Byte long device identification is the MAC address.

The MAC address is divided into:

- 3-Byte manufacturer identification
- 3-Byte device identification (consecutive number)

The MAC address is normally printed on the front of the device.

Example: 08-00-06-6B-80-C0

### Master

When a master is in possession of the token, it can send data to other nodes and request data from other nodes (= active node). The DP masters are, for example, the CPU 315-2 DP or the IM 151-8 PN/DP CPU interface module with DP master module.

### Master

→ *Slave*

### Media redundancy

Function for ensuring the network and system availability. Redundant transmission links (ring topology) ensure that an alternative communication path is made available if a transmission link fails.

### MIB

An MIB (Management Information Base) is a database of a device. SNMP clients access this database in the device. The S7 device family supports, among others, the following standard MIBs:

- MIB II, standardized in the RFC 1213
- LLDP-MIB, standardized in the international standard IEE 802.1AB
- LLDP PNIO-MIB, standardized in the international standard IEE 61158-6-10

### Micro Memory Card

→ *SIMATIC Micro Memory Card*

**Module parameters**

Module parameters are values which can be used to configure module behavior. There are two different types of parameter: static and dynamic.

**NCM PC**

→ *SIMATIC NCM PC*

**Nesting depth**

A block can be called from another by means of a block call. Nesting depth is referred to as the number of simultaneously called code blocks.

*See also Code Blocks*

**Network**

A network is a larger communication system that allows data exchange between a large number of nodes.

All the subnets together form a network.

**Network**

A network consists of one or more interconnected subnets with any number of nodes. Several networks can exist alongside each other.

**Non-isolated**

The reference potentials of the control and load circuit of non-isolated I/O modules are electrically interconnected.

**NTP**

The Network Time Protocol (NTP) is a standard for synchronizing clocks in automation systems via Industrial Ethernet. NTP uses the UDP wireless network protocol.

**OB**

→ *Organization blocks*

**OB priority**

The CPU operating system distinguishes between different priority classes, for example, cyclic program execution or process interrupt-controlled program processing. Each priority class is assigned organization blocks (OBs) in which the S7 user can program a response. The OBs are assigned different default priority classes. These determine the order in which OBs are executed or interrupt each other when they appear simultaneously.

*See also Operating system*

*See also Organization block*

### Operating state

SIMATIC S7 automation systems know the following operating states: STOP, STARTUP, RUN.

*See also STARTUP, RUN*

### Operating system

The CPU OS organizes all functions and processes of the CPU which are not associated to a specific control task.

### Operating system

→ CPU

### Organization blocks

Organization blocks (OBs) form the interface between CPU operating system and the user program. The order in which the user program is executed is defined in the organization blocks.

### Parameter

- Variable of a *STEP 7* code block
- Variable used to set the behavior of a module (one or more per module). All modules have a suitable basic factory setting which can be customized in *STEP 7*. There are static and dynamic parameters.

*See also static parameters*

*See also dynamic parameters*

### Parameter assignment

This means the passing of parameters from the DP master to the DP slave or from the IO controller to the IO device.

### Parameters, dynamic

In contrast to static parameters, you can change dynamic module parameters in runtime by calling an SFC in the user program, e.g. limit values for an analog input module.

### Parameters, static

In contrast to dynamic parameters, static parameters of modules cannot be changed by the user program. You can only modify these parameters by editing your configuration in *STEP 7*, for example, by modifying the input delay parameters of a digital input module.



**PC station**

→ *SIMATIC PC station*

**PELV**

Protective Extra Low Voltage = extra low voltage with safe isolation

**PG**

→ *Programming device*

**PLC**

→ *CPU*

**PLC**

Programmable controllers (PLCs) are electronic controllers whose function is saved as a program in the control unit. Therefore, the configuration and wiring of the unit does not depend on the PLC function. The programmable logic PLC has the structure of a computer; it consists of a CPU with memory, I/O modules and an internal bus system. The I/O and the programming language are oriented to control engineering needs.

**PLC**

→ *PLC*

**PNO**

→ *PROFIBUS International*

**Prioritized startup**

Prioritized startup designates the PROFINET functionality for accelerating the startup of IO devices in a PROFINET IO system with RT and IRT communication.

The function reduces the time that the correspondingly configured IO devices require in order to return to the cyclic user data exchange in the following cases:

- after the supply voltage has returned
- after a station has returned
- after IO devices have been activated

**Priority class**

The S7 CPU operating system provides up to 26 priority classes (or "Program execution levels"). Specific OBs are assigned to these classes. The priority classes determine which OBs interrupt other OBs. Multiple OBs of the same priority class do not interrupt each other. In this case, they are executed sequentially.

### Process image

The process image is part of CPU system memory. At the start of cyclic program execution, the signal states at the input modules are written to the process image of the inputs. At the end of cyclic program execution, the signal status of the process image of the outputs is transferred to the output modules.

*See also System memory*

### Process interrupt

A process interrupt is triggered by interrupt-triggering modules as a result of a specific event in the process. The process interrupt is reported to the CPU. The assigned organization block will be processed according to interrupt priority.

*See also Organization Block*

### Process-Related Function

→ *PROFINET components*

### Product version

The product version identifies differences between products which have the same order number. The product version is incremented when forward-compatible functions are enhanced, after production-related modifications (use of new parts/components) and for bug fixes.

### PROFIBUS

→ *PROFIBUS International*

### PROFIBUS

PROcess Field BUS, German process field bus standard specified in IEC 61784-1:2002 Ed1 CP 3/1. It specifies functional, electrical and mechanical properties for a bit-serial field bus system.

From the perspective of the user program, the distributed I/O is just as sophisticated as the centralized I/O.

PROFIBUS is available with the protocols DP (= Distributed Peripherals), FMS (= Fieldbus Message Specification), PA (= Process Automation), or TF (= Technological Functions.)

### PROFIBUS address

A node must be assigned a unique PROFIBUS address in order to allow its identification on PROFIBUS.

The PC/Programming device is assigned PROFIBUS address "0."

The PROFIBUS addresses 1 to 125 may be used for the ET 200S distributed I/O system.

**PROFIBUS device**

→ *Device*

**PROFIBUS device**

A PROFIBUS device has at least one or more PROFIBUS ports.

A PROFIBUS device cannot take part directly in PROFINET communication but must be included over a PROFIBUS master with a PROFINET port or an Industrial Ethernet/PROFIBUS link (IE/PB Link) with proxy functionality.

**PROFIBUS DP**

→ *PROFIBUS International*

**PROFIBUS DP**

→ *PROFIBUS*

**PROFIBUS International**

Technical committee dedicated to the definition and development of the PROFIBUS and PROFINET standard.

Also known as the PROFIBUS User Organization membership corporation (PNO.)

Homepage: <http://www.profibus.com>

**PROFINET**

→ *PROFIBUS International*

**PROFINET**

Within the framework of Totally Integrated Automation (TIA), PROFINET represents a consequent enhancement of:

- PROFIBUS DP, the established field bus, and
- Industrial Ethernet, the communication bus for the cell level

Experience gained from both systems was and is being integrated into PROFINET.

PROFINET is an Ethernet-based automation standard of PROFIBUS International (previously PROFIBUS Users Organization e.V.), and defines a multi-vendor communication, automation, and engineering model. PROFINET has been part of the standard IEC 61158 since 2003.

**PROFINET ASIC**

→ *ASIC*

## PROFINET CBA

In the context of PROFINET, PROFINET CBA (Component-based Automation) is an automation concept for:

- Implementation of modular applications with distributed intelligence
- Machine-to-machine communication

PROFINET CBA lets you create distributed automation solutions, based on default components and partial solutions. This concept satisfies demands for a higher degree of modularity in the field of mechanical and systems engineering by extensive distribution of intelligent processes.

Component-based Automation allows you to use complete technological modules as standardized components in large systems.

PROFINET CBA is implemented by:

- The PROFINET standard for programmable controllers
- The SIMATIC iMAP engineering tool

The components are created in an engineering tool that can differ from vendor to vendor. Components of SIMATIC devices are created, for example, with *STEP 7*.

## PROFINET components

A PROFINET component encompasses the entire data of the hardware configuration, the parameters of the modules, and the corresponding user program. The PROFINET component is comprised of:

- Technological function

The (optional) technological (software) function includes the interface to other PROFINET components in the form of configurable inputs and outputs.

- Device

The device is the representation of the physical automation device or field device including the IO devices, sensors, actuators, mechanics, and device firmware.

## PROFINET device

→ *Device*

## PROFINET device

A PROFINET device always has at least one Industrial Ethernet port. A PROFINET device can also have a PROFIBUS port as a master with proxy functionality.

## PROFINET IO

Within the framework of PROFINET, PROFINET IO is a communication concept for the implementation of modular, distributed applications.

PROFINET IO allows you to create automation solutions, which are familiar to you from PROFIBUS.

PROFINET IO is based both on the PROFINET standard for programmable controllers and on the *STEP 7* engineering tool. This means that you have the same application view in *STEP 7*, regardless of whether you are configuring PROFINET or PROFIBUS devices. Programming your user program is essentially the same for PROFINET IO and PROFIBUS DP if you use the extended blocks and system status lists for PROFINET IO.

## PROFINET IO Controller

Device via which the connected IO devices are addressed. That means: the IO controller exchanges input and output signals with assigned field devices. The IO controller is often the controller on which the automation program runs.

## PROFINET IO Controller

→ *PROFINET IO Device*

## PROFINET IO Controller

→ *PROFINET IO Supervisor*

## PROFINET IO Controller

→ *PROFINET IO System*

## PROFINET IO Device

→ *PROFINET IO Controller*

## PROFINET IO Device

Distributed field device assigned to one of the IO controllers (e.g. remote IO, valve terminals, frequency converters, switches).

## PROFINET IO Device

→ *PROFINET IO Supervisor*

## PROFINET IO Device

→ *PROFINET IO System*

**PROFINET IO Supervisor**

→ *PROFINET IO Controller*

**PROFINET IO Supervisor**

→ *PROFINET IO Device*

**PROFINET IO Supervisor**

PG/PC or HMI device for commissioning and diagnostics.

**PROFINET IO Supervisor**

→ *PROFINET IO System*

**PROFINET IO System**

→ *PROFINET IO Controller*

**PROFINET IO System**

→ *PROFINET IO Device*

**PROFINET IO System**

PROFINET IO controller with assigned PROFINET IO devices.

**Programming device**

Basically speaking, PGs are compact and portable PCs which are suitable for industrial applications. They are identified by a special hardware and software for programmable logic controllers.

**Proxy**

→ *PROFINET device*

**Proxy**

The PROFINET device with proxy functionality is the substitute for a PROFIBUS device on Ethernet. The proxy functionality allows a PROFIBUS device to communicate not only with its master but also with all nodes on PROFINET.

You can easily integrate existing PROFIBUS systems into PROFINET communication, for example with the help of an IE/PB link or an IM 151-8 PN/DP CPU interface module. The IE/PB link / IM 151-8 PN/DP CPU handles communication via PROFINET as a substitute for the PROFIBUS components.

**Publisher**

→ *Direct data exchange*

**Publisher**

The publisher is a sender in the direct data exchange.

**RAM**

RAM (Random Access Memory) is a semiconductor read/write memory.

**Real Time**

Real time means that a system processes external events within a defined time.

Determinism means that a system reacts in a predictable (deterministic) manner.

In industrial networks, both these requirements are important. PROFINET meets these requirements. PROFINET is implemented as a deterministic real-time network as follows:

- The transfer of time-critical data between different stations over a network within a defined interval is guaranteed.  
To achieve this, PROFINET provides an optimized communication channel for real-time communication : Real Time (RT).
- An exact prediction of the time at which the data transfer takes place is possible.
- It is ensured that seamless communication can take place in the same network by means of other standard protocols, such as industrial communication for programming device / PC.

**Real Time**

→ *Real Time*

**Reference ground**

→ *Ground*

**Reference potential**

Reference potential for the evaluation / measuring of the voltages of participating circuits.

**Restart**

When the IM 151-8 PN/DP CPU interface module starts up (for example, after changing the mode selector switch from STOP to RUN or after a POWER ON), organization block OB 100 (warm restart) is executed before cyclic program processing (OB 1). On restart, the input process image is read in and the *STEP 7* user program is executed, starting at the first instruction in OB1.

### Retentive memory

A memory area is considered retentive if its contents are retained even after a power loss and transitions from STOP to RUN. The non-retentive area of bit memory, timers and counters is reset following a power failure and a transition from the STOP mode to the RUN mode.

Retentive can be the:

- Bit memory
- S7 timers
- S7 counters
- Data areas

### Router

→ *Default router*

### Router

→ *Switch*

### Router

A router connects two subnetworks with each other. A router works in a way similar to a switch. With a router, however, it is also possible to specify which communications nodes can communicate via the router and which cannot. Communication nodes on different sides of a router can only communicate with each other if you have explicitly enabled communication between the two nodes via the router. Real time data cannot be replaced beyond subnetwork limits.

### RT

→ *Real Time*

### Runtime error

Errors occurred in the PLC (that is, not in the process itself) during user program execution.

### Scan cycle check point

The cycle control point is the section of the CPU program processing in which the process image is updated.

### Segment

→ *Bus segment*



**SELV**

Safety Extra Low Voltage

**SFB**

→ *System function block*

**SFC**

→ *System function*

**Shared Device**

The "Shared Device" functionality permits the sub-modules of an IO device to be distributed between various IO controllers.

**SIMATIC**

The term denotes Siemens products and systems for industrial automation.

**SIMATIC Micro Memory Card**

SIMATIC Micro Memory Cards are storage media for the IM 151-8 PN/DP CPU interface module

**SIMATIC NCM PC**

SIMATIC NCM PC is a version of *STEP 7* designed specifically for configuring PCs. It provides the complete *STEP 7* functionality for PC stations.

SIMATIC NCM PC is the central tool with which you configure the communication services for your PC station. The configuration data generated with this tool must be downloaded to the PC station or exported. This makes the PC station ready for communication.

**SIMATIC NET**

Siemens business area for industrial communication, networks, and network components.

**SIMATIC PC station**

A "PC station" is a PC with communication modules and software components within a SIMATIC automation solution.

**Slave**

→ *Master*

## Slave

A slave can only exchange data after being requested to by the master.

## SNMP

SNMP (Simple Network Management Protocol) makes use of the wireless UDP transport protocol. It consists of two network components, similar to the client/server model. The SNMP manager monitors the network nodes and the SNMP agents collect the various network-specific information in the individual network nodes and stores it in a structured form in the **MIB** (Management Information Base). This information allows a network management system to run detailed network diagnostics.

## STARTUP

A STARTUP routine is executed at the transition from STOP to RUN mode. Can be triggered by means of the mode selector switch, or after power on, or by an operator action on the programming device. A restart has been carried out on the IM 151-8 PN/DP CPU interface module.

*See also Mode selector switch*

*See also Restart*

## STEP 7

Engineering system. Contains programming software for the creation of user programs for SIMATIC S7 controllers.

## Subnet mask

The bits set in the subnet mask determine which part of the IP address contains the address of the subnet/network.

In general:

- The network address is obtained by an AND operation on the IP address and subnet mask.
- The node address is obtained by an AND NOT operation on the IP address and subnet mask.

## Subnetwork

All the devices connected by switches are located in the same network, called a subnet. All the devices in a subnet can communicate directly with each other.

All devices in the same subnet have the same subnet mask.

A subnet is physically restricted by a router.

## Subscriber

→ *Direct data exchange*

**Subscriber**

The subscriber is a recipient in the direct data exchange.

**Substitute**

→ *Proxy*

**Substitute value**

Substitute values are configurable values which output modules transfer to the process when the CPU switches to STOP mode.

In the event of an I/O access error, a substitute value can be written to the accumulator instead of the input value which could not be read (SFC 44).

**Switch**

PROFIBUS is based on a line topology. Communication nodes are interconnected by means of a passive cable known as the bus.

By contrast, Industrial Ethernet is made up of point-to-point connections: Each communication node is interconnected directly with one other communication node.

A node is interconnected with several other communication nodes via the port of an active network component (switch). Other communication nodes (including switches) can then be connected to the other ports of the switch. The connection between a communication node and the switch remains a point-to-point connection.

The task of a switch is thus to regenerate and distribute received signals. The switch "learns" the Ethernet address(es) of a connected PROFINET device or of other switches, and passes only the signals intended for the connected PROFINET device or switch.

A switch has a certain number of ports. Connect only one PROFINET device or a further switch to any one of the ports.

**SYNC**

Control command a DP master may broadcast to a group of DP slaves.

With the SYNC control command the DP master causes the DP slave to freeze the statuses of the outputs at the current value. The DP slave stores the output data contained in the next frame, but does not change the state of its outputs.

After each new SYNC control command, the DP slave sets the outputs it has saved as output data. The outputs are not updated cyclically again until the DP master has sent a UNSYNC control command.

**System diagnostics**

System diagnostics refers to the detection, evaluation, and signaling of errors that occur within the PLC, for example programming errors or module failures. System errors can be indicated by LEDs or in *STEP 7*.

### System function

A system function (SFC) is a function integrated in the operating system of the CPU that can be called when necessary in the *STEP 7* user program.

### System function block

A system function block (SFB) is a function block integrated in the operating system of the CPU that can be called when necessary in the *STEP 7* user program.

### System memory

System memory is an integrated RAM memory in the CPU. System memory contains the address areas (e.g. timers, counters, bit memory) and data areas that are required internally by the operating system (for example, communication buffers).

*See also Operating system*

### System status list

The system status list contains data that describes the current status of an ET 200S with IM 151-8 PN/DP CPU interface module. You can always use this list to obtain an overview of:

- the configuration of the ET 200S
- The current CPU parameter assignments and configurable electronic modules
- The current statuses and processes in the CPU and the configurable electronic modules

### Terminating module

The ET 200S distributed IO system is completed by the terminating module. If you have not inserted a terminating module, the ET 200S is not ready for operation.

### Terminating resistor

The terminating resistor is used to avoid reflections on data links.

### Time-of-day interrupt

→ *Interrupt, time-of-day*

### Timer

→ *Timers*

### Timers

Timers are part of CPU system memory. The content of timer cells is automatically updated by the operating system, asynchronously to the user program. *STEP 7* instructions are used to define the precise function of the timer cell (for example, switch-on delay) and to initiate their execution (for example, start).

*See also System memory*

**Token**

Allows access to the PROFIBUS DP for a limited time.

**Topology**

Structure of a network. Common structures include:

- Bus topology
- Ring topology
- Star topology
- Tree topology

**Twisted Pair**

Fast Ethernet via twisted-pair cables is based on the IEEE 802.3u standard (100 Base-TX). Transmission medium is a shielded 2x2 twisted-pair cable with an impedance of 100 Ohm (AWG 22). The transmission characteristics of this cable must meet the requirements of category 5.

The maximum length of the connection between end device and network component must not exceed 100 m. The ports are implemented according to the 100 Base-TX standard with the RJ-45 connector system.

**Update Time**

Within this time interval, an IO device / IO controller in the PROFINET IO system is supplied with new data by the IO controller / IO device. The update time can be configured separately for each IO device and determines the interval at which data is sent from the IO controller to the IO device (outputs) as well as data from the IO device to the IO controller (inputs).

**User program**

In SIMATIC, a distinction is made between the operating system of the CPU and user programs. The user program contains all instructions, declarations and data for signal processing required to control a plant or a process. It is assigned to a programmable module (for example CPU) and can be structured in smaller units (blocks).

**User program**

→ *Operating system*

**User program**

→ *STEP 7*

**Voltage group**

A group of electronic modules supplied by one power module.

**WAN**

Wide Area Network; extends beyond LAN limits and allows worldwide communication. Legal rights do not belong to the user, but to the provider of the WAN networks.

**Work memory**

The work memory is integrated in the CPU and cannot be extended. It is used to run the code and process user program data. Programs only run in work memory and system memory.

*See also CPU*

# Index

(  
(Simple Network Management Protocol), 40

## A

Accessories  
  IM 151-8 PN/DP CPU, 244  
Address area  
  of the I/O modules, 134  
Address assignment  
  for analog and digital modules, 134  
Addresses  
  Start addresses, 136  
Addressing  
  Assignment of addresses, 136  
  slot-oriented, 133  
  Unassigned, 136  
Application transfer areas, 106  
Application View, 96  
Asynchronous error, 207  
Automation concept, 96

## B

Back up  
  Operating system, 181  
  The firmware, 181  
Basic knowledge required, 3  
Blocks, 100  
  compatibility, 100  
  Deleting, 121  
  Delta download, 120  
  Download, 117  
  Encryption, 119  
  Reloading, 120  
  Upload, 120  
Bus terminator, 188, 190

## C

Commissioning  
  Check list, 147  
  Hardware Requirements, 143  
  IM 151-8 PN/DP CPU as a DP master, 166

  Procedure with the hardware, 144  
  Procedure with the software, 145  
  PROFIBUS DP, 165  
  PROFINET IO, 172  
  Reaction to errors, 146  
  Software requirement, 145  
Commissioning stage, 228  
Communication  
  Communication protocols, 41  
  Data consistency, 40  
  Data set routing, 38  
  OP communication, 36  
  Open IE communication, 41  
  Programming device communication, 35  
  S7 communication, 36  
  Services of the IM 151-8 PN/DP CPU interface module, 33  
Communication load  
  configured, 252  
  Dependency of actual cycle time, 253  
  Influence on the actual cycle time, 253  
Communications concept, 96  
Component-Based automation, 96  
Compression, 121  
Connect the PROFINET connector, 130  
Connect the RJ45 connector, 130  
Connecting  
  IM 151-8 PN/DP CPU, 128  
  PG, 158  
Connecting the supply voltage, 131  
Connection  
  DP master module, 132  
Consistency, 137, 139  
Constant bus cycle time, 168  
Cross circuit detection, 199  
Cycle time  
  Calculation, 250  
  Definition, 247  
  Extension, 249  
  Process image, 247  
  Sequence of cyclic program processing, 248  
  Time slice model, 247

## D

Data consistency, 40  
Data set routing, 38  
Default addressing, 133

Deleting, 121  
 Delta download, 120  
 Diagnostics  
     in DP Master mode, 224  
     with Diagnosing Hardware, 210  
     with LEDs, 213  
     with system functions, 209  
 Diagnostics address, 225  
 Diagnostics buffer, 208, 227  
 Diagnostics Concept, 228  
 Dimensional diagram  
     DP master module, 246  
     IM 151-8 PN/DP CPU, 245  
 Direct data exchange, 170  
 Display elements  
     DP master module, 26  
 Display languages  
     of the web server, 54  
 Disposal, 6  
 Documentation  
     Additional, 261  
 Download  
     of blocks, 117  
 DP master module  
     connecting, 132  
     Dimensional diagram, 246  
     Display elements, 26  
     installing, 132  
     Properties, 19  
     Technical specifications, 242

**E**

Error  
     Asynchronous, 207  
     Synchronous, 207  
 Error displays, 25  
 ET 200S with IM 151-8 PN/DP CPU  
     initial power on, 150  
 Event recognition, 226

**F**

Failure  
     ET 200S (PROFINET IO), 188, 190  
 Firewall, 53  
 Firmware  
     Back up, 181  
 Forcing, 205  
 FREEZE, 169

**G**

Guide  
     Operating Instructions, 6

**I**

I&M data, 202  
 I/O process image, 113  
 I/O transfer areas, 106  
 Identification and maintenance data, 202  
 Identification data, 202  
 I-Device  
     Application transfer areas, 106  
     I/O transfer areas, 106  
     IP address assignment, 139  
 IM 151-8 PN/DP CPU  
     Accessories, 244  
     commissioning as a DP master, 167  
     Connecting, 128  
     Dimensional diagram, 245  
     installing, 127  
     Memory reset, 151  
     Properties, 16  
     Response after replacement, 189  
     Technical specifications, 230  
 IM 151-8 PN/DP CPU factory settings  
     Lamp images during reset, 157  
     Properties, delivery state, 156  
     Restore delivery state, 156  
 Industrial Ethernet, 95  
 Installing  
     DP master module, 132  
     IM 151-8 PN/DP CPU, 127  
 interfaces  
     PROFIBUS DP interface:Time synchronization, 32  
 Interfaces  
     PROFIBUS DP interface, 32  
     PROFIBUS DP interface:Connectable devices, 33  
     PROFINET interface, 27  
     PROFINET interface properties, 28  
     PROFINET interface: configuring the port  
         properties, 29  
     PROFINET interface:Addressing the ports, 30  
     PROFINET interface:Connectable devices, 28  
     PROFINET interface:Disabling a port, 29  
     PROFINET interface:Send clock, 30  
     PROFINET interface:Time synchronization, 27  
     PROFINET interface:Update Time, 30  
     PROFINET send clock interface, 31  
     PROFINET Update Time interface, 31  
 Internet



- Service & support, 7
- Interrupt response time
  - Definition, 259
  - IM 151-8 PN/DP CPU, 259
  - Process interrupt processing, 260
- IRT, 103

**L**

- LAN, 128
- LED
  - LED, 19
- Load memory, 109
- Local data, 115
- Longest response time
  - Calculation, 259
  - Conditions, 258

**M**

- Maintenance data, 202
- Media redundancy, 128
- Memory
  - Compression, 121
- Memory areas
  - Load memory, 109
  - System memory, 109
  - Work memory, 110
- Memory functions
  - Compression, 121
  - Deleting blocks, 121
  - Delta downloading for blocks, 120
  - Download of blocks, 117
  - Downloading blocks, 120
  - Memory reset, 121
  - Promming, 121
  - RAM to ROM, 121
  - Restart, 121
  - Uploading blocks, 120
  - Warm start, 121
- Memory reset, 151
  - with mode selector switch, 152
- Mode selector switch, 24
  - Memory reset, 152
- Modifying
  - of variables, 204
- Monitor
  - of variables, 204
- Monitoring and modifying variables
  - Controlling outputs in STOP of the IM 151-8 PN/DP CPU interface module, 164

- Creating a connection to the IM 151-8 PN/DP CPU interface module, 163
- Creating a variable table, 161
- Modifying variables, 162
- Monitor variable, 161
  - opening the VAT, 163
  - Saving the variable table, 163
  - setting the trigger points, 162
- MRP, 108

**N**

- Network Diagnostics, 211
- Network node, 37
- Non-whole number send clock, 31

**O**

- OB 83, 102
- OB86, 102
- OP communication, 36
- Open user communication, 78
- Operating Instructions
  - Changes since previous version, 4
  - Purpose, 3
- Operating system
  - Back up, 181
  - Update, 182
- Order numbers
  - Accessories, 244
  - Cables, 244
  - Connector, 244
  - DP master module, 243
  - IM 151-8 PN/DP CPU, 243
- Organization blocks, 102
- OUC, 78

**P**

- Parameterization
  - Reference junction, 193
- PELV, 128
- PG
  - Connecting, 158
- Pin assignment
  - Bus connector, 132
  - Pin assignment for supply voltage, 131
  - RJ45 connector, 130
- Power module
  - Status byte, 199
- Power on

- initial, 150
  - Requirements, 150
- Process interrupt processing, 260
- PROFIBUS, 165
- PROFIBUS DP
  - Commissioning, 165
  - Direct data exchange, 170
- PROFIBUS DP interface, 32
- PROFIBUS International, 96
- PROFINET, 172
  - Device replacement without removable medium, 104
  - I-Device, 106
  - Implementation, 96
  - Isochronous mode, 105
  - Isochronous real time communication, 103
  - Media redundancy, 108
  - Objectives, 95
  - Prioritized startup, 103
  - Shared Device, 107
  - Switch, 128
- PROFINET CBA, 96
- PROFINET interface, 27
  - IO device, troubleshooting, 222
- PROFINET IO, 172
  - Commissioning, 172
- Programming device communication, 35
- Properties
  - DP master module, 19
  - IM 151-8 PN/DP CPU, 16

## R

- RAM to ROM, 121
- Recycling, 6
- Reference junction
  - Parameter assignment, 193
- Reloading, 120
- Replacing
  - DP master module, 191
  - IM 151-8 PN/DP CPU interface module, 189
- Response time
  - Calculating the longest, 259
  - Calculation, 257
  - Conditions, 257
  - Conditions for the longest, 258
  - Definition, 255
  - DP cycle times, 255, 256
  - Factors, 255
  - Fluctuation width, 255
- Restart, 121
- Retentive memory, 110

- Load memory, 110
  - Retentive behavior of the memory objects, 111
  - System memory, 110
- Ring topology, 27
- Routing
  - Access to a CPU on another subnet, 37
  - Network node, 37
  - Requirements, 38

## S

- S7 Block Privacy, 119
- S7 communication, 36
- S7 connections
  - Distribution, 47
  - End point, 44
  - IM 151-8 PN/DP CPU, 48
  - Time sequence for allocation, 46
  - Transition point, 44
- Scope
  - Operating Instructions, 3
- Security
  - of the web server, 53
- SELV, 128
- Service & Support, 7
- Service case, 228
- Service data
  - Application, 201
  - Procedure, 201
- SF LED
  - Evaluation, 215
- SFB 52, 101
- SFB 53, 101
- SFB 54, 101
- SFB 81, 101
- SFC 12, 100
- SFC 14, 137, 139
- SFC 15, 137, 139
- SFC 49, 100
- SFC 58, 100
- SFC 59, 100
- SFC 70, 101
- SFC 71, 101
- SFC102, 101
- SFC13, 100
- SFC5, 100
- Shortest response time
  - Calculation, 257
  - Conditions, 257
- SIMATIC Manager, 160
  - start, 160
- SIMATIC Micro Memory Card

- Properties, 116
- Service life, 117
- Slot, 24
- Slot assignment
  - ET 200S, 134
- Slot-oriented addressing of the centralized I/O modules, 133
- SNMP, 40, 211
- Startup
  - IM 151-8 PN/DP CPU as a DP master, 167
  - IM 151-8 PN/DP CPU as an IO controller, 177
  - IM151-8 PN/DP CPU as an I device, 178
- Status and error LEDs
  - PROFINET IO devices, 222
- Status byte, 199
- Status displays, 25
- Stepping mode, 204
- Switch, 128
- SYNC, 169
- Synchronous error, 207
- System and Standard Functions, 100, 101
- System memory, 109
  - I/O process image, 113
  - Local data, 115

## T

- Technical specifications
  - DP master module, 242
  - IM 151-8 PN/DP CPU, 230
- Time-delay interrupt, 260
- Training center, 6
- Transfer memory
  - Access from the user program, 137, 139
- Troubleshooting, 207

## U

- Update
  - Operating system, 182
- Upload, 120
- Useful life of a SIMATIC Micro Memory Card, 117
- User program
  - Deleting, 121
  - Delta download, 120
  - Reloading, 120
  - Upload, 120
- User-oriented addressing of the I/O Modules, 136

## V

- Variables
  - Forcing, 205
  - Modifying, 204
  - Monitor, 204

## W

- WAN, 128
- Warm start, 121
- Watchdog interrupt, 260
- Web access to IM 151-8 PN/DP CPU
  - via HMI devices, 52
  - via PDA, 52
  - via programming device / PC, 52
- Web server, 51
  - Access only by HTTPS, 57
  - activate, 56
  - Automatic update, 58
  - Display classes of the messages, 58
  - Display languages, 54
  - Printing refresh status, 59
  - Screen content refresh status, 59
  - Security, 53
  - Set the language, 57
  - Status of the modules, 67
  - Topology, 80
  - User list, 57
  - User pages, 91
    - without SIMATIC Micro Memory Card, 53
- Work memory, 110

