

### Contents

Contents	Pages
<b>Section Overview</b> . . . . .	10/2 - 10/3
<b>3SB2, 16mm Mounting Diameter Pilot Devices</b>	
Introduction . . . . .	10/4
Technical Specifications . . . . .	10/5
PCB Mounting Instructions . . . . .	10/6
Complete Units . . . . .	10/7 - 10/8
Pushbutton and Selector Switch Operators . . . . .	10/9
Key-operated Switches and Indicator Lights . . . . .	10/10
Holders, Lampholders and Contact Blocks with Tabs . . . . .	10/11
Holders, Lampholders and Contact Blocks with Solder Pins . . . . .	10/12
Inserts, Legend Plates, and Accessories . . . . .	10/13 - 10/19
Dimension Drawings . . . . .	10/20
<b>SIRIUS ACT 3SU Series</b>	
Introduction . . . . .	10/22 - 10/23
General Data . . . . .	10/24 - 10/36
Actuators and indicators, 22 mm, round, plastic, black	
Complete Units . . . . .	10/37 - 10/42
Compact Units . . . . .	10/43 - 10/44
Actuating and Signaling Elements . . . . .	10/45 - 10/56
Actuators and indicators, 22 mm, round, plastic with metal front ring, matte	
Complete Units . . . . .	10/57 - 10/62
Compact Units . . . . .	10/63 - 10/64
Actuating and Signaling Elements . . . . .	10/65 - 10/76
Actuators and indicators, 22 mm, round, metal, shiny	
Complete Units . . . . .	10/77 - 10/81
Compact Units . . . . .	10/82 - 10/84
Actuating and Signaling Elements . . . . .	10/85 - 10/94
Actuators and indicators, flat, 30 mm, round, metal, matte	
Actuating and Signaling Elements . . . . .	10/95 - 10/97
Special locks . . . . .	10/98
Customized Designs . . . . .	10/99 - 10/101
Holders	
Holders without module . . . . .	10/102
Holders with module . . . . .	10/103
Modules for actuators and indicators	
Contact modules . . . . .	10/104
LED modules . . . . .	10/106
AS-Interface modules . . . . .	10/108
Electronic modules for ID key-operated switches . . . . .	10/109
Enclosures	
General data . . . . .	10/110
Empty enclosures . . . . .	10/111
Pushbuttons and indicator lights in the enclosure . . . . .	10/112
Pushbuttons and indicator lights in the enclosure for AS-Interface . . . . .	10/116
Modules for enclosures . . . . .	10/118
Two-hand operation consoles . . . . .	10/121
Labels	
Insert labels . . . . .	10/122
Label holders for labeling plates . . . . .	10/125
Labeling plates . . . . .	10/126
Labeling plates for enclosures . . . . .	10/132
Labels for laser printers . . . . .	10/135
Other labels . . . . .	10/136
Accessories	
Protection/access protection . . . . .	10/138
Actuators . . . . .	10/142
Enclosures . . . . .	10/144
Miscellaneous accessories . . . . .	10/146
Standards and approvals . . . . .	10/147 - 10/148

### Contents

Contents	Pages
<b>Sirius Signal Columns</b>	
Introduction . . . . .	10/151 - 10/152
Technical Specifications . . . . .	10/153
8WD42 signaling columns, 50 mm diameter and accessories . . . . .	10/154 - 10/155
8WD44 signaling columns, 70 mm diameter and accessories . . . . .	10/156 - 10/159
8WD53 beacons, 70 mm diameter . . . . .	10/160
Dimensional Drawings . . . . .	10/161 - 10/163
<b>3SE2, 3SE3 Foot Switches</b>	
Introduction . . . . .	10/149
Plastic and Metal Enclosures . . . . .	10/150
<b>Class 50 Standard Duty Control Stations</b>	
Introduction . . . . .	10/164
Standard Duty Type 1 and 1B . . . . .	10/165 - 10/169
Heavy Duty Type 4 Stations . . . . .	10/170
Class 50 Accessories . . . . .	10/171
Dimension Drawings . . . . .	10/172
<b>Class 51 NEMA Type 7/9 Hazardous Location Pilot Devices</b>	
Introduction . . . . .	10/173
Pushbutton and Push-pull Operators . . . . .	10/174
Indicator Lights . . . . .	10/175
Push to Test/Illuminated Pushbutton Complete Units . . . . .	10/176
Selector Switch Operators . . . . .	10/177
Keyed Selector Switch Operators . . . . .	10/178
Cam Selection Guide for Selector Switch . . . . .	10/179
Stations and Enclosures . . . . .	10/180
Accessories . . . . .	10/181 - 10/183
<b>Class 52 30.5mm Mounting Diameter Pilot Devices</b>	
Introduction . . . . .	10/184
Momentary Push Button, Non-Illuminated . . . . .	10/185 - 10/186
2 & 3 Position Push-Pull Mushroom Head Devices, Non-Illuminated . . . . .	10/187 - 10/188
2 & 3 Position Push-Pull Mushroom Head Devices, Illuminated . . . . .	10/189 - 10/190
2 Position Twist-to-Release Mushroom Head Devices, Non-Illuminated . . . . .	10/191
2 Position Twist-to-Release Mushroom Head Devices, Illuminated . . . . .	10/192
Indicator Light . . . . .	10/193 - 10/194
Push Button & Push-to-Test, Illuminated . . . . .	10/195 - 10/196
Push Button Mushroom Head Devices, Illuminated . . . . .	10/197
Selector Switches, Illuminated . . . . .	10/198
Selector Switch Short & Long Lever, Non-Illuminated . . . . .	10/199 - 10/200
Keyed Selector Switch . . . . .	10/201 - 10/202
Selector Push Button . . . . .	10/203
Special Devices . . . . .	10/204
Cam Selection Guide for Selector Switch, Keyed Selector Switch and Selector Pushbutton . . . . .	10/205
Custom Selector Switch Designs . . . . .	10/206
Accessories and Spare Parts . . . . .	10/207 - 10/210
Dimensional Drawings . . . . .	10/211 - 10/214
<b>Class 52 30.5mm Enclosed Pushbutton Stations</b>	
Assembled Enclosures with Standard Devices . . . . .	10/215 - 10/216
P30 Empty Enclosures Only . . . . .	10/217
Enclosure Legend Plates . . . . .	10/218
Enclosure Dimensions . . . . .	10/219
Technical Specifications . . . . .	10/220

### 16 mm mounting diameter, molded-plastic



#### 3SB2

Page

#### Selection and ordering data

- 3SB22 complete units 10/7
- 3SB20 pushbuttons and lens assemblies 10/9
- 3SB2 holders, lampholders and contact blocks 10/11
- 3SB29 inserts, legend plates, and accessories 10/13

- Introduction 10/4
- Technical specifications 10/5
- Dimension drawings 10/20

### 22 mm mounting diameter, plastic black



#### SIRIUS ACT – 3SU1

Page

#### Selection and ordering data

- Complete units 10/37
- Compact units 10/43
- Actuating and signaling Elements 10/45
- Accessories 10/102 – 10/109; 10/122 – 10/143

### 22 mm mounting diameter, plastic with metal matte front ring



#### SIRIUS 3SB3, plastic round

Page

#### Selection and ordering data

- Complete units 10/57
- Compact units 10/63
- Actuating and signaling Elements 10/65
- Accessories 10/102 – 10/109; 10/122 – 10/143

### 22 mm mounting diameter, metal shiny



#### SIRIUS ACT – 3SU1

Page

#### Selection and ordering data

- Complete units 10/77
- Compact units 10/82
- Actuating and signaling Elements 10/85
- Accessories 10/102 – 10/109; 10/122 – 10/143

### 30 mm mounting diameter, metal matte



#### SIRIUS ACT – 3SU1

Page

#### Selection and ordering data

- Actuating and signaling Elements 10/95
- Accessories 10/118 – 10/120; 10/144 – 10/146

### 22mm enclosures and communication devices



#### SIRIUS ACT – 3SU1

Page

#### Selection and ordering data

- Empty enclosures 10/111
- Complete enclosure 10/112
- AS-Interface 10/116
- Accessories 10/118 – 10/120; 10/144 – 10/146
- Two-hand operation 10/121

### SIRIUS signal columns, built-in signal beacons and foot switches

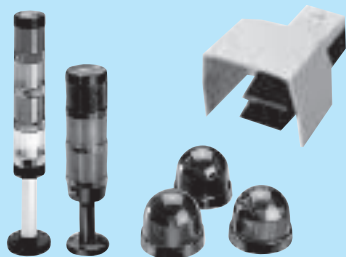

#### 3SE2, 3SE3 Foot Switches Page

• Plastic and metal enclosures 10/150

#### Lamp & LED version, enclosure diameters 50 and 70 mm

- 8WD42 selection and accessories 10/154
- 8WD44 selection and accessories 10/115
- 8WD53 beacons 10/119

Introduction	10/151
Technical Specifications	10/153
Dimension drawings	10/161

### Standard duty control stations



#### Class 50 Page

- Standard duty Type 1 and 1B 10/165
- Heavy duty Type 4 10/170
- Class 50 accessories 10/171

Introduction	10/164
Technical Specifications	10/164
Dimension drawings	10/172

### Type 7/9 hazardous location — 3/4"–14 NPSM

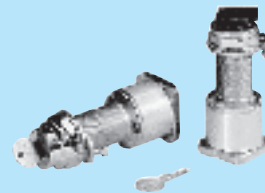

#### SIRIUS ACT – 3SU1 Page

#### Selection and ordering data

- Push pull complete units 10/174
- Pilot lights 10/175
- Selector switches 10/177
- Push to test/illuminated push buttons 10/176
- Cam selection guide 10/179
- Stations and enclosures 10/180
- Accessories 10/181

Introduction	10/173
Technical Specifications	10/173

### NEMA 30.5 mm mounting diameter, corrosion resistant, watertight & oiltight

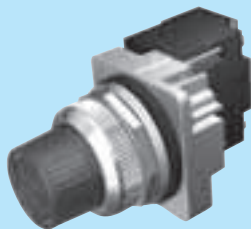

#### Class 52 Page

#### Selection and ordering data

- Momentary Push Button, Non-Illuminated 10/185-10/186
- 2 & 3 Position Push-Pull Mushroom Head Devices, Non-Illuminated 10/187-10/188
- 2 & 3 Position Push-Pull Mushroom Head Devices, Illuminated 10/189-10/190
- 2 Position Twist-to-Release Mushroom Head Devices, Non-Illuminated 10/191
- 2 Position Twist-to-Release Mushroom Head Devices, Illuminated 10/192
- Indicator Light 10/193-10/194

Introduction	10/143
Technical Specifications	10/178
Dimension drawings	10/169

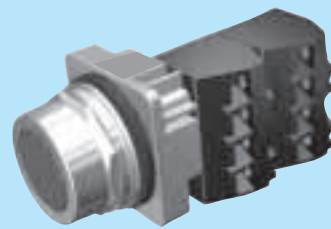

#### Class 52 Page

#### Selection and ordering data

- Push Button & Push-to-Test, Illuminated 10/195-10/196
- Push Button Mushroom Head Devices, Illuminated 10/197
- Selector Switches, Illuminated 10/198
- Selector Switch Short & Long Lever, Non-Illuminated 10/199-10/200
- Keyed Selector Switch 10/201-10/202
- Selector Push Button 10/203

### 30.5 mm heavy duty control stations, Type 4/4X/12/13 enclosures



#### Class 52 Page

#### Selection and ordering data

- Class 52 assembled stations with standard offerings 10/214
- P30 enclosures only 10/216
- Custom station order form 10/216
- Legend plates 10/217

# Push Button Units and Indicator Lights

## 3SB2, Mounting Diameter 16 mm

### General data

#### Overview

The 3SB2 push buttons and indicator lights are provided for front plate mounting and rear connection with flat connectors. For use on printed circuit boards, contact blocks and lamp holders with solder pins are also available.

#### Standards

IEC 60947-1, EN 60947-1,  
IEC 60947-5-1, EN 60947-5-1,  
IEC 60947-5-5, EN 60947-5-5 for EMERGENCY-STOP mushroom push buttons.

#### Version with flat connector

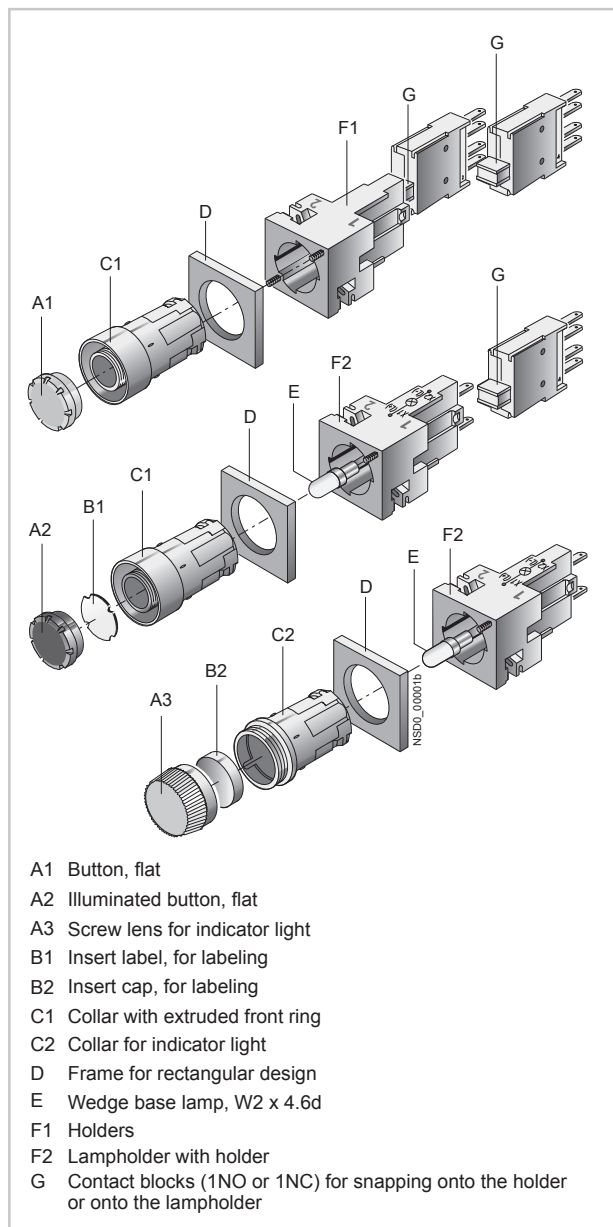

#### For PCB mounting

For use on printed circuit boards, special contact blocks and lamp holders for soldering into the printed circuit board are available. For this purpose, the contact blocks and lamp holders are fitted with 0.8 mm x 0.8 mm solder pins of length 3.5 mm.

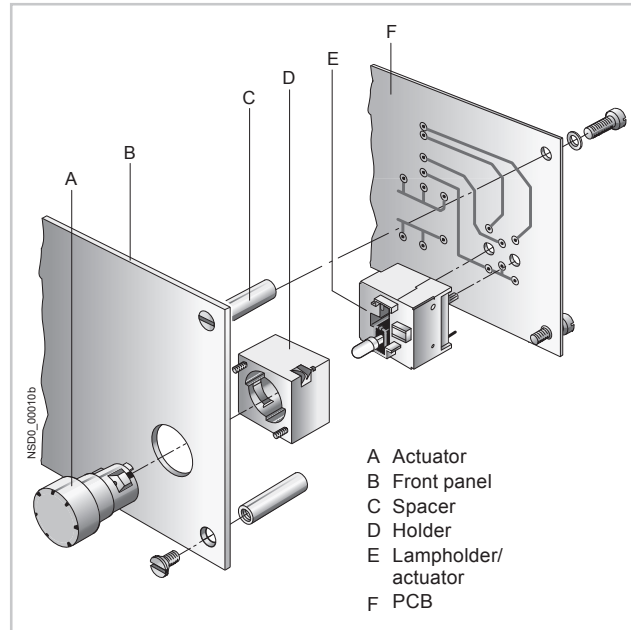

#### Connection methods



Flat connectors



Solder pin connections

The terminals are indicated in the corresponding tables by the symbols shown on blue backgrounds.

#### Application

The devices are climate-proof and suitable for marine applications.

#### Safety EMERGENCY-STOP push buttons according to ISO 13850

For controls according to IEC 60204-1 or EN 60204-1, the mushroom push buttons of the 3SB2 series are suitable for use as safety EMERGENCY-STOP push buttons.

#### Safety circuits

IEC 60947-5-1 and EN 60947-5-1 require positive opening, i.e. for the purposes of personal safety, the assured opening of NC contacts is expressly stipulated for the electrical equipment of machines in all safety circuits and marked according to IEC 60947-5-1 with the symbol ☹.

Category 4 according to EN 954-1 can be attained with the EMERGENCY-STOP mushroom push buttons if the corresponding failsafe evaluation units are selected and correctly installed, e.g. the 3TK28 safety relays or matching units from the ASIsafe, SIMATIC or SINUMERIK product ranges.



# Push Button Units and Indicator Lights

## 3SB2, Mounting Diameter 16 mm

### General data

1  
2  
3  
4  
5  
6  
7  
8  
9  
10

### Technical specifications

Type	3SB2	
<b>Contact blocks and lamp holders</b>		
<b>Standards</b>	IEC 60947-5-1, EN 60947-5-1 IEC 60947-5-5, EN 60947-5-5	
<b>Rated insulation voltage <math>U_i</math></b>	V	250
<b>Conventional thermal current <math>I_{th}</math></b>	A	10
<b>Rated operational current <math>I_e</math> at rated operational voltage <math>U_e</math></b>		
• Alternating current AC-12 - At $U_e = 24 \dots 230$ V	A	10
• Alternating current AC-15 - At $U_e = 24 \dots 230$ V	A	4
• Direct current DC-12 - At $U_e = 24$ V	A	6
- At $U_e = 60$ V	A	5
- At $U_e = 110$ V	A	2.5
- At $U_e = 230$ V	A	1
• Direct current DC-13 - At $U_e = 24$ V	A	3
- At $U_e = 60$ V	A	1.5
- At $U_e = 110$ V	A	0.7
- At $U_e = 230$ V	A	0.3
<b>Contact stability</b>		
• Test voltage/test current	5 V/1 mA	
<b>Lamps</b>		
• Bases	Wedge base W2× 4.6 d	
• Rated voltage	V	6, 12, 24, 30, 48, 60
• Rated power, max.	W	1
<b>Short-circuit protection</b> weld-free according to IEC 60947-5-1		
• DIAZED fuse links, utilization category gG	10 A TDz, 16 A Dz	
• Miniature circuit breaker with C characteristic according to IEC 60898	10 A	
<b>Electrical endurance</b>		
• For utilization category AC-15 with 3RT10 15 to 3RT10 26 contactors	$10 \times 10^6$ operating cycles	
<b>Mechanical endurance</b>	$10 \times 10^6$ operating cycles	
<b>Degree of protection</b> acc. to IEC 60529		
• Connection of contact blocks and lamp holders behind the front panel	IP00	
• Contact chambers of the contact blocks behind the front panel	IP40	
<b>Finger-safe</b> according to IEC 61140 and BGV A3	With voltages > 50 V AC or 120 V DC, insulation sleeves must be fitted to the unassigned tab connections.	
<b>Data according to UL and CSA</b>		
<b>Rated voltage</b>		
• Contact blocks	V	250 AC
• Indicator light (lamp with wedge base W2× 4.6 d)	V	60; 1 W
<b>Uninterrupted current</b>	A	5
<b>Switching capacity</b>	B 300, R 300	
<b>Actuators and indicators</b>		
<b>Mechanical endurance</b>		
• Push Buttons	$10 \times 10^6$ operating cycles	
• Actuators, rotary or maintained	$3 \times 10^5$ operating cycles	
• Illuminated push buttons	$3 \times 10^6$ operating cycles	
<b>Climatic withstand capability</b>	Climate-proof; suitable for marine applications	
<b>Ambient temperature</b>		
• During operation, non-illuminated devices and complete with LED	°C	-25 ... +70
• During operation, devices with incandescent lamp	°C	-25 ... +60
• During storage, transport	°C	-40 ... +80
<b>Degree of protection</b> acc. to IEC 60529		
• Actuators and indicators	IP65	
• Actuators and indicators with protective cap	IP67	
<b>Protective measures</b>		
• For mounting in metal front plates and enclosures	The actuators and lens assemblies must not be included in the protective measures.	
• For fitting into enclosures with total insulation	The protective measure "Total insulation" is retained.	
<b>Shock resistance</b> acc. to IEC 60068-2-27		
• Shock amplitude	ms	≤ 50 g
• Shock duration		11
• Shock form		Half-sine

More technical information see [Reference manual "Commanding and Signaling Devices"](#).

# Push Button Units and Indicator Lights

## 3SB2, Mounting Diameter 16 mm

### General data

#### Configuration

##### Design

Two design versions can be mounted:

- Round design: The 3SB2 push buttons and indicator lights are assembled with the modules – actuator, holder, contact block and lamp holder. Depending on the specific application, various versions can be assembled. Complete units are offered for the most commonly used applications.
- Square design: With square, black frames the round units can be given a square look. The frames are inserted underneath the round actuators. Further mounting is the same as for the round version.

Mounting and fixing:

Mounting dimensions according to EN 50007  
(not applicable to EMERGENCY-STOP mushroom push buttons)

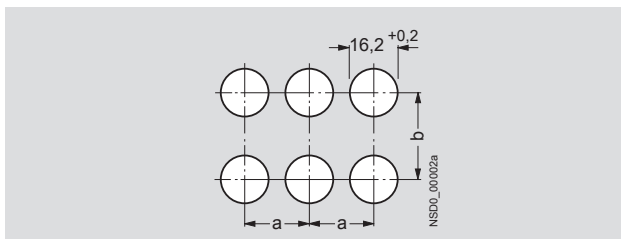

Minimum clearance	a	b
Round version	19	19
Square version without inscription label	21	21
Round and square version with inscription label	21	32
For 2 selector switches with 3 switch positions, maintained, side by side	21	21

For mounting, the actuator or the lens assembly is inserted from the front into the hole in the front plate. Four small nubs ensure a secure fitting in the hole. The holder is plugged on from the back and snaps automatically into place. The module is fixed to the holder with 2 screws so that it is immune to vibrations.

One or two contact blocks can be mounted on the holder. They are inserted into the holder with slide slots and held down with two snap brackets.

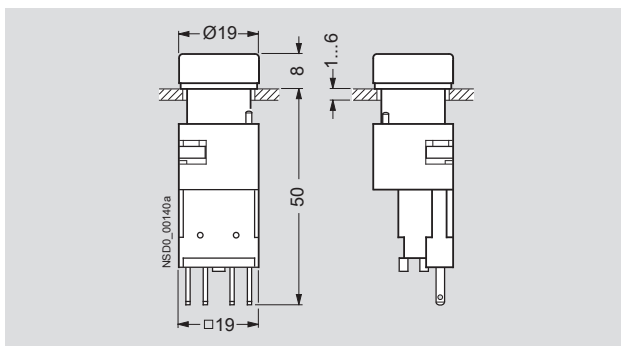

Push button (flat) with holder and contact block

If a command point is fitted with an indicator light or illuminated push button, a lamp socket with lamp holder must be used instead of a holder. It is suitable for incandescent lamps or LEDs with bases of type W2 × 4.6d.

#### For PCB mounting

The command point comprises the actuator – e.g. 3SB2 push button, illuminated push button or indicator light –, which is mounted in the front plate, and a contact block and a lamp holder which are soldered to the PCB. For this purpose, the contact blocks and lamp holders are fitted with 0.8 mm × 0.8 mm solder pins of length 3.5 mm.

Mounting and fixing:

Mounting dimensions according to EN 50007.

The actuators are mounted in the same way as 3SB2 front plate mounting devices.

The contact blocks and lamp holders are plugged into the printed circuit board by means of their solder pins and can be flow-soldered. After soldering, the devices must be flush with the board and perpendicular to it. The printed circuit board must be supported on spacing bolts so that it cannot sag or bend more than 0.1 mm.

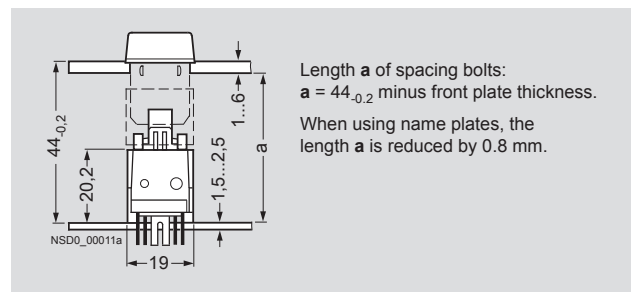

Illuminated push button with solder pin connection

To avoid bending the PCB when the control device is operated, sufficient spacing bolts must be provided as shown in the table below:

PCB thickness	Max. distance between spacing bolts
1.5 mm	80 mm
2.5 mm	150 mm
When using EMERGENCY-STOP push buttons	always 50 mm

These details are based on epoxy resin glass fiber mat.

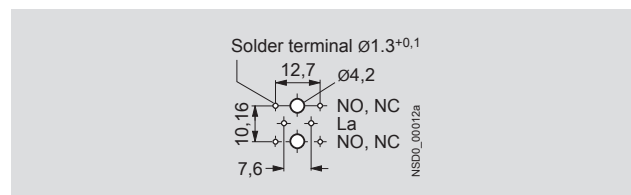

Solder pin spacing







# Push Button Units and Indicator Lights

## 3SB2, Mounting Diameter 16 mm

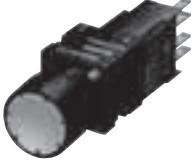
Complete units

1  
2  
3  
4  
5  
6  
7  
8  
9  
10

### Selection and ordering data

	Version	Contact blocks	DT	Color of handle	Flat connectors	PS		
					Order No.			
 <p>Pushbutton with flat button</p>	<b>Push buttons with flat button</b>	1 NO		Black	3SB22 02-0AB01	1 unit		
		1 NC		Black	3SB22 03-0AB01	1 unit		
		1 NC		Red	3SB22 03-0AC01	1 unit		
		1 NO		Yellow	3SB22 02-0AD01	1 unit		
		1 NO		Green	3SB22 02-0AE01	1 unit		
		1 NO		Blue	3SB22 02-0AF01	1 unit		
		1 NO		White	3SB22 02-0AG01	1 unit		
		1 NO		Clear <sup>1)</sup>	3SB22 02-0AH01	1 unit		
		 <p>Illuminated push button with raised button</p>	<b>Illuminated push buttons with flat button</b> Lamp holder W2 x 4.6 d <sup>2)</sup>	1 NC		Red	3SB22 07-0AC01	1 unit
				1 NO		Yellow <sup>1)</sup>	3SB22 06-0AD01	1 unit
1 NO				Green	3SB22 06-0AE01	1 unit		
1 NO				Blue	3SB22 06-0AF01	1 unit		
1 NO				Clear <sup>1)</sup>	3SB22 06-0AH01	1 unit		
 <p>EMERGENCY-STOP mushroom push button</p>	<b>Illuminated push buttons with raised button</b> Lamp holder W2 x 4.6 d with incandescent lamp 24 V	1 NC		Red	3SB22 27-0AC01	1 unit		
		1 NO		Yellow <sup>1)</sup>	3SB22 26-0AD01	1 unit		
		1 NO		Green	3SB22 26-0AE01	1 unit		
		1 NO		Blue	3SB22 26-0AF01	1 unit		
		1 NO		Clear <sup>1)</sup>	3SB22 26-0AH01	1 unit		
 <p>EMERGENCY-STOP mushroom push button</p>	<b>Push buttons with raised button</b>	1 NO		Black	3SB22 02-0LB01	1 unit		
		1 NC		Red	3SB22 03-0LC01	1 unit		
		1 NO		Yellow	3SB22 02-0LD01	1 unit		
		1 NO		Blue	3SB22 02-0LF01	1 unit		
		1 NO		Clear <sup>1)</sup>	3SB22 02-0LH01	1 unit		
		 <p>Illuminated push button with raised button</p>	<b>Illuminated push buttons with raised button</b> Lamp holder W2 x 4.6 d <sup>2)</sup>	1 NC		Red	3SB22 07-0LC01	1 unit
				1 NO		Yellow <sup>1)</sup>	3SB22 26-0LD01	1 unit
				1 NO		Green	3SB22 06-0LE01	1 unit
				1 NO		Blue	3SB22 06-0LF01	1 unit
				1 NO		Clear <sup>1)</sup>	3SB22 06-0LH01	1 unit
 <p>Illuminated push button with raised button</p>	<b>Illuminated push buttons with raised button</b> Lamp holder W2 x 4.6 d with incandescent lamp 24 V	1 NC		Red	3SB22 27-0LC01	1 unit		
		1 NO		Yellow <sup>1)</sup>	3SB22 26-0LD01	1 unit		
		1 NO		Green	3SB22 26-0LE01	1 unit		
		1 NO		Blue	3SB22 26-0LF01	1 unit		
		1 NO		Clear <sup>1)</sup>	3SB22 26-0LH01	1 unit		
 <p>EMERGENCY-STOP mushroom push button</p>	<b>EMERGENCY-STOP mushroom push buttons acc. to ISO 13850, maintained<sup>3)</sup></b> Latches automatically when pressed; unlatches by turning the mushroom head anticlockwise, with yellow name plate, with inscription "NOT-HALT"	1 NC	⊕ <sup>4)</sup>	Red	3SB22 03-1AC01	1 unit		

<sup>1)</sup> Inscription is possible by inserting a label.

<sup>2)</sup> For wedge base lamps see "Accessories", page 10/18.





<sup>3)</sup> The mushroom push button cannot be combined with 3SB29 02-0AB name plate or 3SB29 02-0AA single frame.





<sup>4)</sup> Positive opening according to IEC 60947-5-1, Appendix K.

# Push Button Units and Indicator Lights

## 3SB2, Mounting Diameter 16 mm

### Complete units

Version	Contact blocks	Color of handle	DT	Flat connectors	PS
				Order No.	
 <p>Selector switch</p>	<b>Selector switches, 2 switch positions</b> Switching sequence O-I, 62° operating angle, maintained 	1 NO 1 NO 1 NO 1 NO	Black Red Green White	<b>3SB22 02-2AB01</b> <b>3SB22 02-2AC01</b> <b>3SB22 02-2AE01</b> <b>3SB22 02-2AG01</b>	1 unit 1 unit 1 unit 1 unit
	<b>Selector switches, 3 switch positions</b> Switching sequence I-O-II, 2 × 62° operating angle, maintained 	1 NO, 1 NO 1 NO, 1 NO 1 NO, 1 NO 1 NO, 1 NO	Black Red Green White	<b>3SB22 10-2DB01</b> <b>3SB22 10-2DC01</b> <b>3SB22 10-2DE01</b> <b>3SB22 10-2DG01</b>	1 unit 1 unit 1 unit 1 unit
	<b>Selector switches, 3 switch positions</b> Switching sequence I-O-II, 2 × 50° operating angle, momentary, Spring return from left and right 	1 NO, 1 NO 1 NO, 1 NO 1 NO, 1 NO 1 NO, 1 NO	Black Red Green White	<b>3SB22 10-2EB01</b> <b>3SB22 10-2EC01</b> <b>3SB22 10-2EE01</b> <b>3SB22 10-2EG01</b>	1 unit 1 unit 1 unit 1 unit

Version	Contact blocks	Lock No.	Key removal position	DT	Flat connectors	PS
					Order No.	
 <p>CES key-operated switch</p>	<b>CES key-operated switches, 2 switch positions</b> Switching sequence O-I, 62° operating angle, maintained 	1 NO 1 NO	SB2 SB2	O O + I	<b>3SB22 02-4LA01</b> <b>3SB22 02-4LB01</b>	1 unit 1 unit
	<b>CES key-operated switches, 3 switch positions</b> Switching sequence I-O-II, 2 × 62° operating angle, maintained 	1 NO, 1 NO 1 NO, 1 NO	SB2 SB2	O I + O + II	<b>3SB22 10-4PA01</b> <b>3SB22 10-4PB01</b>	1 unit 1 unit
	<b>CES key-operated switches, 3 switch positions</b> Switching sequence I-O-II, 2 × 50° operating angle, momentary, Spring return from left and right 	1 NO, 1 NO	SB2	O	<b>3SB22 10-4QA01</b>	1 unit

Version	Color of screw lens	DT	Flat connectors	PS
			Order No.	
 <p>Indicator light</p>	<b>Indicator lights</b> Lamp holder W2 x 4.6 d without lamp <sup>1)</sup>	Red Yellow Green White Clear	<b>3SB22 04-6BC06</b> <b>3SB22 04-6BD06</b> <b>3SB22 04-6BE06</b> <b>3SB22 04-6BG06</b> <b>3SB22 04-6BH06</b>	1 unit 1 unit 1 unit 1 unit 1 unit
	<b>Indicator lights</b> Lamp holder W2 x 4.6 d with incandescent lamp 24 V	Red Yellow Green White Clear	<b>3SB22 24-6BC06</b> <b>3SB22 24-6BD06</b> <b>3SB22 24-6BE06</b> <b>3SB22 24-6BG06</b> <b>3SB22 24-6BH06</b>	1 unit 1 unit 1 unit 1 unit 1 unit

<sup>1)</sup> For wedge base lamps see "Accessories", page 10/18.



# Push Button Units and Indicator Lights

## 3SB2, Mounting Diameter 16 mm

Actuators and indicators

1  
2  
3  
4  
5  
6  
7  
8  
9  
10

### Selection and ordering data







Version	Color of handle	DT	Order No.	PS		
<b>Push buttons</b>						
 Push button and illuminated push button with flat button	<b>Push buttons with flat button</b>	Black Red Yellow Green Blue White Clear <sup>1)</sup>	<b>3SB20 00-0AB01</b> <b>3SB20 00-0AC01</b> <b>3SB20 00-0AD01</b> <b>3SB20 00-0AE01</b> <b>3SB20 00-0AF01</b> <b>3SB20 00-0AG01</b> <b>3SB20 00-0AH01</b>	1 unit 1 unit 1 unit 1 unit 1 unit 1 unit 1 unit		
	<b>Illuminated push buttons with flat button</b>	Red Yellow <sup>1)</sup> Green Blue White Clear <sup>1)</sup>	<b>3SB20 01-0AC01</b> <b>3SB20 01-0AD01</b> <b>3SB20 01-0AE01</b> <b>3SB20 01-0AF01</b> <b>3SB20 00-0AG01</b> <b>3SB20 00-0AH01</b>	1 unit 1 unit 1 unit 1 unit 1 unit 1 unit		
	 Push button and illuminated push button with raised button	<b>Push buttons with raised button</b>	Black Red Yellow Blue White Clear <sup>1)</sup>	<b>3SB20 00-0LB01</b> <b>3SB20 00-0LC01</b> <b>3SB20 00-0LD01</b> <b>3SB20 00-0LF01</b> <b>3SB20 00-0LG01</b> <b>3SB20 00-0LH01</b>	1 unit 1 unit 1 unit 1 unit 1 unit 1 unit	
		<b>Illuminated push buttons with raised button</b>	Red Yellow <sup>1)</sup> Green Blue Clear <sup>1)</sup>	<b>3SB20 01-0LC01</b> <b>3SB20 01-0LD01</b> <b>3SB20 01-0LE01</b> <b>3SB20 01-0LF01</b> <b>3SB20 00-0LH01</b>	1 unit 1 unit 1 unit 1 unit 1 unit	
		<b>EMERGENCY-STOP mushroom push buttons acc. to ISO 13850, maintained<sup>2)</sup></b>		Red	<b>3SB20 00-1AC01</b>	1 unit
		Latches automatically when pressed; unlatches by turning the mushroom head anticlockwise				
		 EMERGENCY-STOP mushroom push button				

<sup>1)</sup> Inscription is possible by inserting a label.

<sup>2)</sup> The mushroom push button cannot be combined with 3SB29 02-0AB name plate or 3SB29 02-0AA single frame.

Version	Color of handle	DT	Order No.	PS
---------	-----------------	----	-----------	----

### Selector switches

 Selector switch	<b>Selector switches with 2 switch positions</b> Switching sequence O-I, 62° operating angle, maintained		Black Red Green White	<b>3SB20 00-2AB01</b> <b>3SB20 00-2AC01</b> <b>3SB20 00-2AE01</b> <b>3SB20 00-2AG01</b>	1 unit 1 unit 1 unit 1 unit
	<b>Selector switches with 2 switch positions</b> Switching sequence O-I, 50° operating angle, momentary, spring return from right		Black Red Green	<b>3SB20 00-2BB01</b> <b>3SB20 00-2BC01</b> <b>3SB20 00-2BE01</b>	1 unit 1 unit 1 unit
	<b>Selector switches with 2 switch positions</b> Switching sequence O-I, 90° operating angle, maintained		Black Red Green White	<b>3SB20 00-2HB01</b> <b>3SB20 00-2HC01</b> <b>3SB20 00-2HE01</b> <b>3SB20 00-2HG01</b>	1 unit 1 unit 1 unit 1 unit
	<b>Selector switches with 3 switch positions</b> Switching sequence I-O-II, 2 x 62° operating angle, maintained		Black Red Green White	<b>3SB20 00-2DB01</b> <b>3SB20 00-2DC01</b> <b>3SB20 00-2DE01</b> <b>3SB20 00-2DG01</b>	1 unit 1 unit 1 unit 1 unit
	<b>Selector switches with 3 switch positions</b> Switching sequence I-O-II, 2 x 50° operating angle, momentary, spring return from left and right		Black Red Green White	<b>3SB20 00-2EB01</b> <b>3SB20 00-2EC01</b> <b>3SB20 00-2EE01</b> <b>3SB20 00-2EG01</b>	1 unit 1 unit 1 unit 1 unit
	<b>Selector switches with 3 switch positions</b> Switching sequence I-O-II, 2 x 90° operating angle, maintained		Black	<b>3SB20 00-2JB01</b>	1 unit



# Push Button Units and Indicator Lights

## 3SB2, Mounting Diameter 16 mm

### Actuators and indicators

Version	Lock No.	Key removal position	DT	Order No.	PS
---------	----------	----------------------	----	-----------	----

#### Key-operated switches



CES key-operated switch

<p><b>CES key-operated switches with 2 keys, 2 switch positions</b> Switching sequence O-I, 62° operating angle, maintained</p> <p><b>CES key-operated switches with 2 keys, 2 switch positions</b> Switching sequence O-I, 50° operating angle, momentary, spring return from right</p> <p><b>CES key-operated switches with 2 keys, 3 switch positions</b> Switching sequence I-O-II, 2 x 62° operating angle, maintained</p> <p><b>CES key-operated switches with 2 keys, 3 switch positions</b> Switching sequence I-O-II, 2 x 50° operating angle, momentary, spring return from left and right</p>		SB2	O+I O	<b>3SB20 00-4LB01</b> <b>3SB20 00-4LA01</b>	1 unit 1 unit
		SB2	O	<b>3SB20 00-4MA01</b>	1 unit
		SB2	I+O+II O	<b>3SB20 00-4PB01</b> <b>3SB20 00-4PA01</b>	1 unit 1 unit
		SB2	O	<b>3SB20 00-4QA01</b>	1 unit

Version	Color of screw lens	DT	Order No.	PS
---------	---------------------	----	-----------	----

#### Indicator lights



Indicator light

<p><b>Indicator lights with concentric rings</b> (inscription by inserting a cap is not possible)</p> <p><b>Indicator lights, smooth</b> for inscription by inserting a cap<sup>1)</sup></p>	Red	<b>3SB20 01-6BC06</b>	1 unit
	Yellow	<b>3SB20 01-6BD06</b>	1 unit
	Green	<b>3SB20 01-6BE06</b>	1 unit
	Blue	<b>3SB20 01-6BF06</b>	1 unit
	White	<b>3SB20 01-6BG06</b>	1 unit
	Clear	<b>3SB20 01-6BH06</b>	1 unit
	Red	<b>3SB20 01-6CC06</b>	1 unit
	Yellow	<b>3SB20 01-6CD06</b>	1 unit
	Green	<b>3SB20 01-6CE06</b>	1 unit
	Blue	<b>3SB20 01-6CF06</b>	1 unit
Clear	<b>3SB20 01-6CH06</b>	1 unit	

<sup>1)</sup> Insert caps, see "Accessories", page 10/15



# Push Button Units and Indicator Lights

## 3SB2, Mounting Diameter 16 mm

### Contact blocks and lampholders

1  
2  
3  
4  
5  
6  
7  
8  
9  
10

#### Selection and ordering data

Version	Diagram	Operating travel  Contact closed  Contact open	DT	Flat connectors 	PS
				Order No.	

#### Contact blocks and lamp holders with flat connectors 2 x 2.8 – 0.8 mm according to IEC 60760

##### Holders for fixing the actuator and the contact blocks



Holder

Holders for 2 contact blocks  
Inscription with identification number 1-2

3SB29 08-0AA 5 units

##### Lamp holders with holder for fixing the actuator and the contact blocks



Lamp holder

##### Lamp holders

W2 x 4.6 d  
without lamp

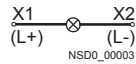

3SB23 04-2A 1 unit

##### Lamp holders

W2 x 4.6 d

- With 6 V incandescent lamp
- With 24 V incandescent lamp

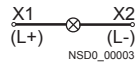

3SB23 04-2F 1 unit  
3SB23 04-2H 1 unit

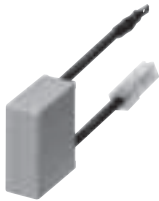

Voltage reducer

##### Voltage reducers<sup>1)</sup>

For connecting the 3SB29 08-1AE lamp (48 V) to 230 V AC

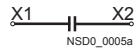

3SB24 04-3D 1 unit

##### Contact blocks for fixing in the holder or lamp holder

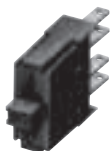

Contact block

##### Contact blocks with one contact<sup>2)</sup>

1 NO

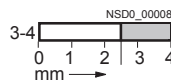

3SB24 04-0B 1 unit

1 NC <sup>3)</sup>

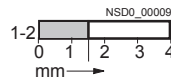

3SB24 04-0C 1 unit

<sup>1)</sup> Use fixpoint terminal according to IEC 60439-1.

<sup>2)</sup> For plug-in and insulation sleeves see "Accessories", page 10/19.

<sup>3)</sup> Positive opening according to IEC 60947-5-1, Appendix K.

# Push Button Units and Indicator Lights

## 3SB2, Mounting Diameter 16 mm

### Contact blocks and lamp holders

Version	Diagram	Operating travel	DT	Solder pin connections	PS
		<input type="checkbox"/> Contact closed <input type="checkbox"/> Contact open			

Order No.

#### Contact blocks and lamp holders with solder pins

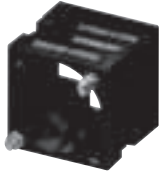

Holder

**Holders for contact block with solder pins**  
For fixing the actuators in the front panel

**Lamp holders**  
Wedge base W2 x 4.6 d<sup>1)</sup>



**3SB29 08-0AB** 5 units

**3SB24 55-2A** 1 unit



Contact block with solder pins

#### Contact blocks

1 NO

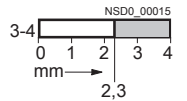

**3SB24 55-0B** 1 unit

1 NC

⊖<sup>2)</sup>

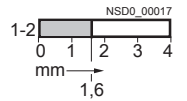

**3SB24 55-0C** 1 unit

1 NO + 1 NC

⊖<sup>2)</sup>

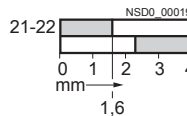

**3SB24 55-0J** 1 unit

1 NO + 1 NO

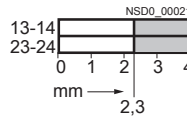

**3SB24 55-0E** 1 unit

1 NC + 1 NC

⊖<sup>2)</sup>

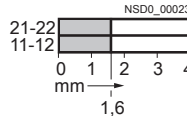

**3SB24 55-0F** 1 unit



Contact block and lamp holder with solder pins

#### Contact blocks and lamp holders, wedge base W2 x 4.6 d<sup>1)</sup>

1 NO

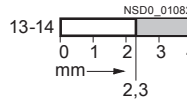

**3SB24 55-1B** 1 unit

1 NC

⊖<sup>2)</sup>

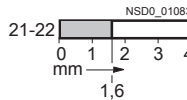

**3SB24 55-1C** 1 unit

1 NO + 1 NC

⊖<sup>2)</sup>

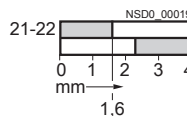

**3SB24 55-1J** 1 unit

1 NO + 1 NO

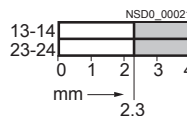

**3SB24 55-1E** 1 unit

1 NC + 1 NC

⊖<sup>2)</sup>

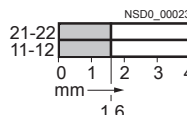

**3SB24 55-1F** 1 unit

<sup>1)</sup> The lamp is not included in the scope of supply.

# Push Button Units and Indicator Lights

## 3SB2, Mounting Diameter 16 mm

Insert labels and insert caps

1  
2  
3  
4  
5  
6  
7  
8  
9  
10

### Overview

Clear push buttons, illuminated push buttons and indicator lights can be fitted with insert labels and caps for identification purposes.

The insert labels and insert caps are made of a milky-transparent plastic with black lettering; they can be fitted in any 90° angle.

### Inscriptions

The inscriptions have upper case initial letters. Graphic symbols, including those not listed in the catalog, are according to ISO 7000 or IEC 60417.

For customized inscriptions see "Options".

### Selection and ordering data

Inscription/Symbol	Symbol No.	DT	Insert labels For push buttons and illuminated push buttons, flat Order No.	PS
--------------------	------------	----	---	----

#### For self-inscription



Blank

3SB29 01-4AA

10 units

#### With inscription



On  
Start  
Stop  
Reset  
Test

3SB29 01-4EB  
3SB29 01-4EK  
3SB29 01-4EL  
3SB29 01-4EM  
3SB29 01-4EN

10 units  
10 units  
10 units  
10 units  
10 units

0  
1  
2  
3  
4  
5  
6  
7  
8  
9

3SB29 01-4RA  
3SB29 01-4RB  
3SB29 01-4RC  
3SB29 01-4RD  
3SB29 01-4RE  
3SB29 01-4RF  
3SB29 01-4RG  
3SB29 01-4RH  
3SB29 01-4RJ  
3SB29 01-4RK

10 units  
10 units  
10 units  
10 units  
10 units  
10 units  
10 units  
10 units  
10 units  
10 units

#### Graphic ON/OFF symbols



O (Off)



5008 IEC

3SB29 01-4MB

10 units

I (On)



5007 IEC

3SB29 01-4MC

10 units

II (On)



--























3SB29 01-4MD

10 units

# Push Button Units and Indicator Lights

## 3SB2, Mounting Diameter 16 mm

### Insert labels and insert caps

Inscription/Symbol	Symbol No.	DT	Insert labels For push buttons and illuminated push buttons, flat Order No.	PS
<b>Graphic equipment symbols</b>				
 Electric motor	 0011 ISO		<b>3SB29 01-4PA</b>	10 units
Horn	 5014 IEC		<b>3SB29 01-4PB</b>	10 units
Pump	 0134 ISO		<b>3SB29 01-4PD</b>	10 units
Coolant pump	 0355 ISO		<b>3SB29 01-4PE</b>	10 units
<b>Graphic motion symbols</b>				
 Motion in direction of arrow (straight)	 5022 IEC		<b>3SB29 01-4NA</b>	10 units
Motion in direction of arrow (diagonal)	 --		<b>3SB29 01-4NB</b>	10 units
Clockwise rotation	 0004 ISO		<b>3SB29 01-4NC</b>	10 units
Anticlockwise rotation	 --		<b>3SB29 01-4ND</b>	10 units
Fast motion	 0266 ISO		<b>3SB29 01-4NE</b>	10 units
Increase (plus)	 5005 IEC		<b>3SB29 01-4NG</b>	10 units
Decrease (minus)	 5006 IEC		<b>3SB29 01-4MC</b>	10 units
<b>Graphic control symbols</b>				
 Clamp	 --		<b>3SB29 01-4QB</b>	10 units
Release	 --		<b>3SB29 01-4QC</b>	10 units
Brake off	 0021 ISO		<b>3SB29 01-4QE</b>	10 units
Lock	 0022 ISO		<b>3SB29 01-4QF</b>	10 units
Unlock	 0023 ISO		<b>3SB29 01-4QG</b>	10 units
On/Off, momentary contact	 5011 IEC		<b>3SB29 01-4QJ</b>	10 units
Manual operation	 0096 ISO		<b>3SB29 01-4QK</b>	10 units
Automatic sequence	 0017 ISO		<b>3SB29 01-4QL</b>	10 units
<b>Customized inscriptions</b>				
 <b>Any inscription</b> 1 line of text with up to 6 characters of 3 mm in height. Please add the appropriate order code to the Order No. and specify the line of text required.			<b>3SB29 01-4AZ</b> <b>K0Y</b> <b>K1Y</b> or <b>K2Y</b> <b>K5Y</b>	1 unit 1 unit 1 unit
<b>Other graphic symbols</b> Please add the order code " <b>K3Y</b> " to the Order No. and specify the serial number and the applied standard (ISO 7000 or IEC 60417).			<b>3SB29 01-4AZ</b> <b>K3Y</b>	1 unit
<b>Any inscription or symbol</b> Please add the order code " <b>K9Y</b> " to the Order No. and specify the inscription or the symbol required.			<b>3SB29 01-4AZ</b> <b>K9Y</b>	1 unit



# Push Button Units and Indicator Lights

## 3SB2, Mounting Diameter 16 mm

### Insert labels and insert caps

1  
2  
3  
4  
5  
6  
7  
8  
9  
10

Inscription/Symbol	Symbol No.	DT	Insert caps For push buttons and illuminated push buttons, raised Order No.	PS
--------------------	------------	----	---	----





#### For self-inscription

	Blank		<b>3SB29 01-5AA</b>	10 units
---	-------	--	---------------------	----------





#### With inscription

	On		<b>3SB29 01-5EB</b>	10 units
	0		<b>3SB29 01-5RA</b>	10 units
	1		<b>3SB29 01-5RB</b>	10 units
	2		<b>3SB29 01-5RC</b>	10 units
	3		<b>3SB29 01-5RD</b>	10 units
	4		<b>3SB29 01-5RE</b>	10 units
	5		<b>3SB29 01-5RF</b>	10 units
	6		<b>3SB29 01-5RG</b>	10 units
	7		<b>3SB29 01-5RH</b>	10 units
	8		<b>3SB29 01-5RJ</b>	10 units
	9		<b>3SB29 01-5RK</b>	10 units

#### Graphic ON/OFF symbols

	O (Off)		5008 IEC	<b>3SB29 01-5MB</b>	10 units
	I (On)		5007 IEC	<b>3SB29 01-5MC</b>	10 units
	II (On)		--	<b>3SB29 01-5MD</b>	10 units

#### Graphic motion symbols

	Motion in direction of arrow		5022 IEC	<b>3SB29 01-5NA</b>	10 units
	Motion in direction of arrow		--	<b>3SB29 01-5NB</b>	10 units
	Increase (plus)		5005 IEC	<b>3SB29 01-5NG</b>	10 units
	Decrease (minus)		5006 IEC	<b>3SB29 01-5MC</b>	10 units

#### Graphic control symbols

	Clamp		--	<b>3SB29 01-5QB</b>	10 units
	Release		--	<b>3SB29 01-5QC</b>	10 units





#### Customized inscriptions

	<b>Any inscription</b> 1 line of text with up to 6 characters of 3 mm in height. Please add the appropriate order code to the Order No. and specify the line of text required.			<b>3SB29 01-5AZ</b> <b>K0Y</b> <b>K1Y</b> or <b>K2Y</b> <b>K5Y</b>	1 unit 1 unit 1 unit
	<b>Other graphic symbols</b> Please add the order code " <b>K3Y</b> " to the Order No. and specify the serial number and the applied standard (ISO 7000 or IEC 60417).			<b>3SB29 01-5AZ</b> <b>K3Y</b>	1 unit
	<b>Any inscription or symbol</b> Please add the order code " <b>K9Y</b> " to the Order No. and specify the inscription or the symbol required.			<b>3SB29 01-5AZ</b> <b>K9Y</b>	1 unit

# Push Button Units and Indicator Lights

## 3SB2, Mounting Diameter 16 mm

### Insert labels and insert caps

Inscription/Symbol	Symbol No.	DT	Insert caps For indicator lights Order No.	PS
<b>For self-inscription</b>				
 Blank			<b>3SB29 01-7AA</b>	10 units
<b>Graphic symbols</b>				
 Pump		0134 ISO	<b>3SB29 01-7PD</b>	10 units
 Manual operation		0096 ISO	<b>3SB29 01-7QK</b>	10 units
<b>Customized inscriptions</b>				
	<b>Any inscription</b> 1 line of text with up to 6 characters of 3 mm in height. Please add the appropriate order code to the Order No. and specify the line of text required.		<b>3SB29 01-7AZ</b> <b>K0Y</b> <b>K1Y</b> or <b>K2Y</b> <b>K5Y</b>	1 unit 1 unit 1 unit
	<b>Other graphic symbols</b> Please add the order code " <b>K3Y</b> " to the Order No. and specify the serial number and the applied standard (ISO 7000 or IEC 60417).		<b>3SB29 01-7AZ</b> <b>K3Y</b>	1 unit
	<b>Any inscription or symbol</b> Please add the order code " <b>K9Y</b> " to the Order No. and specify the inscription or the symbol required.		<b>3SB29 01-7AZ</b> <b>K9Y</b>	1 unit

### Options

#### Customized inscriptions

Labels and caps can be inscribed with text and symbols not listed in the ordering data. Append the following codes to the Order No.:

- Text line in upper/lower case, always upper case for beginning of line (e.g. "Lift"): **K0Y**
- Text line in upper case (e.g. "LIFT"): **K1Y**
- Text line in lower case (e.g. "lift"): **K2Y**
- Text line in upper/lower case, all words begin with upper case letters (e.g. "Lift"): **K5Y**
- Symbol with number according to ISO 7000 or IEC 60417: **K3Y**
- Any inscription or symbols according to order form supplement: **K9Y**

When ordering, specify the required inscription in plain text in addition to the order number and order code. In the case of special inscriptions with words in languages other than German, give the exact spelling and specify the language.

One line with up to 6 characters with 3 mm letter height is possible for the inscription (see [ordering example 1](#)).

Symbols can also be ordered with numbers according to ISO 7000 or IEC 60417 (see [ordering examples 2 and 3](#)).

For special symbols (order code K9Y), a CAD drawing in DXF format can be submitted.

#### Ordering example 1

3SB29 01-4AZ  
K1Y  
Z = pump

#### Ordering example 2

3SB29 01-4AZ  
K3Y  
Z = 5008 IEC

#### Ordering example 3

3SB29 01-4AZ  
K3Y  
Z = 1118 ISO

# Push Button Units and Indicator Lights

## 3SB2, Mounting Diameter 16 mm

Name plates

1

2

3

4

5

6

7

8

9

10

### Overview





The name plates consist of a black plastic label holder and an inscription label (silver with black print) for sticking in place.

Note mounting dimensions!

### Inscriptions

The inscriptions (also special inscriptions) are lower case with upper case initial letters. Graphic symbols, including those not listed in the catalog, are according to ISO 7000 or IEC 60417.

### Selection and ordering data

Inscription/Symbol	Symbol No.	DT	Order No.	PS
<b>Inscription labels, self-adhesive, 9.5 mm x 18.5 mm</b>				
 Blank			<b>3SB29 01-2AA</b>	10 units
On			<b>3SB29 01-2EB</b>	10 units
Off			<b>3SB29 01-2EC</b>	10 units
Start			<b>3SB29 01-2EL</b>	10 units
Reset			<b>3SB29 01-2EM</b>	10 units
Fault			<b>3SB29 01-2EW</b>	10 units
Hand Auto			<b>3SB29 01-2BA</b>	10 units
Manual 0 Auto			<b>3SB29 01-2BE</b>	10 units
Man 0 Auto			<b>3SB29 01-2ET</b>	10 units
<b>Graphic symbols</b>				
O (Off)		5008 IEC	<b>3SB29 01-2MB</b>	1 unit
I (On)		5007 IEC	<b>3SB29 01-2MC</b>	1 unit
O I (horizontal)		--	<b>3SB29 01-2MF</b>	1 unit
Motion in direction of arrow		5002 IEC	<b>3SB29 01-2NA</b>	1 unit
<b>Customized inscriptions or symbols</b>				
(see Options)			<b>3SB29 01-2XZ</b>	
			<b>K0Y</b>	1 unit
			<b>K1Y, K2Y or K3Y</b>	1 unit
			<b>K5Y</b>	1 unit
			<b>K9Y</b>	1 unit

### Label holders



#### Label holders for inscription labels

The label holders must not be used with the 3SB2...-1AC01 EMERGENCY-STOP mushroom push button.

**3SB29 02-0AB** 1 unit

### Options

#### Customized inscriptions

The labels can be inscribed with text and symbols not listed in the ordering data. Append the following codes to the Order No.:

- Text line(s) in upper/lower case, upper case always for beginning of line (e.g. "Lift off"): **K0Y**
- Text line(s) in upper case (e.g. "LIFT OFF"): **K1Y**
- Text line(s) in lower case (e.g. "lift off"): **K2Y**
- Text line(s) in upper/lower case, all words begin with upper case letters (e.g. "Lift Off"): **K5Y**
- Symbol with number according to ISO 7000 or IEC 60417: **K3Y**
- Any inscription or symbols according to order form supplement: **K9Y**

When ordering, specify the required inscription in plain text in addition to the order number and order code. In the case of special inscriptions with words in languages other than German, give the exact spelling and specify the language.

Two lines of 11 characters are permitted with 4 mm letter height (1 line) or 3 mm (2-line).

Symbols can also be ordered with numbers according to ISO 7000 or IEC 60417 (see ordering example).

For special symbols (order code K9Y), a CAD drawing in DXF format can be submitted.

#### Ordering example











3SB29 01-2XZ  
K3Y  
Z = 1118 ISO

# Push Button Units and Indicator Lights

## 3SB2, Mounting Diameter 16 mm

### Mounting parts and components

#### Selection and ordering data

Version	Lamp voltage	Color	DT	Order No.	PS
V					
<b>Buttons and lenses<sup>1)</sup></b>					
 3SB29 10-0AF	<b>Buttons, flat</b> For push buttons	Black		3SB29 10-0AB	1 unit
		Red		3SB29 10-0AC	1 unit
		Yellow		3SB29 10-0AD	1 unit
		Green		3SB29 10-0AE	1 unit
		Blue		3SB29 10-0AF	1 unit
		White		3SB29 10-0AG	1 unit
		Clear		3SB29 10-0AH	1 unit
 3SB29 10-0CF	<b>Buttons, flat</b> For illuminated push buttons	Red		3SB29 10-0CC	1 unit
		Yellow		3SB29 10-0CD	1 unit
		Green		3SB29 10-0CE	1 unit
		Blue		3SB29 10-0CF	1 unit
		White		3SB29 10-0AG	1 unit
		Clear		3SB29 10-0AH	1 unit
		 3SB29 10-0BD	<b>Buttons, raised</b> For push buttons	Black	
Red				3SB29 10-0BC	1 unit
Yellow				3SB29 10-0BD	1 unit
Clear				3SB29 10-0BH	1 unit
 3SB29 10-0DD	<b>Buttons, raised</b> For illuminated push buttons	Red		3SB29 10-0DC	1 unit
		Yellow		3SB29 10-0DD	1 unit
		Clear		3SB29 10-0BH	1 unit
 3SB29 10-1AD	<b>Screw lenses</b> With concentric rings	Red		3SB29 10-1AC	1 unit
		Yellow		3SB29 10-1AD	1 unit
		Green		3SB29 10-1AE	1 unit
		Blue		3SB29 10-1AF	1 unit
		White		3SB29 10-1AG	1 unit
		Clear		3SB29 10-1AH	1 unit
 3SB29 10-1BE	<b>Screw lenses</b> Smooth, for inscription with insert cap	Red		3SB29 10-1BC	1 unit
		Yellow		3SB29 10-1BD	1 unit
		Green		3SB29 10-1BE	1 unit
		Blue		3SB29 10-1BF	1 unit
		Clear		3SB29 10-1BH	1 unit
<b>Key for actuators</b>					
 3SB29 08-2AJ	<b>Keys</b> For CES key-operated switch, lock No. SB2			3SB29 08-2AJ	1 unit
<b>Lamps, wedge bases<sup>2)</sup></b>					
 3SB29 08-1AE	<b>Incandescent lamps</b> Wedge base W2 × 4.6 d, 1.0 W	AC/DC	Clear		
		6		3SB29 08-1AA	1 unit
		12		3SB29 08-1AB	1 unit
		24		3SB29 08-1AC	1 unit
		30		3SB29 08-1AD	1 unit
		48		3SB29 08-1AE	1 unit
		60		3SB29 08-1AF	1 unit
 3SB39 01-1SB	<b>LED lamps, super-bright</b> Wedge base W2 × 4.6 d	24 AC/DC	Red	3SB39 01-1SB	1 unit
			Yellow	3SB39 01-1RB	1 unit
			Green	3SB39 01-1TB	1 unit
			White	3SB39 01-1UB	1 unit
			Blue	3SB29 08-1BD	1 unit
		28 AC/DC	Red	3SB39 01-1SE	1 unit
			Yellow	3SB39 01-1RE	1 unit
Green	3SB39 01-1TE		1 unit		
White	3SB39 01-1UE		1 unit		
Blue	3SB39 01-1VE		1 unit		
 3SB29 08-1AB	<b>Lamp extractors</b> For lamps with bases W2 × 4.6 d			3SB29 08-2AB	1 unit

<sup>1)</sup> Included in the scope of supply of actuators or indicator lights.

<sup>2)</sup> Included in the scope of supply of some complete units.

# Push Button Units and Indicator Lights

## 3SB2, Mounting Diameter 16 mm

### Mounting parts and components

1

2

3

4

5

6

7

8

9

10

Version	DT	Order No.	PS
---------	----	-----------	----

#### Accessories for command points



3SB29 02-0AA

**Single frames** for square design<sup>1)</sup>

3SB29 02-0AA

1 unit



3SB29 08-2AG

**Name plates, yellow, Ø 50 mm**

As backing plate for EMERGENCY-STOP, self-adhesive

- Blank
- With German inscription "NOT-HALT"
- With German inscription "NOT-AUS"

3SB29 08-2AF  
3SB29 08-2AG  
3SB29 08-2AK

1 unit  
1 unit  
1 unit



3SB29 08-3AA

**Blanking plugs**

Black plastic  
(degree of protection IP65)

3SB29 08-3AA

1 unit



3SB29 08-1

**Protective caps, clear**

Silicone, for push buttons with flat and raised button

3SB29 08-3AB

1 unit

#### Flat connectors



3SB29 08-8AA

**Plug-in sleeves**

For flat connectors 2.8 × 0.8 mm, cross-section 0.5 ... 1.5 mm<sup>2</sup>

3SB29 08-8AA

1 unit



3SB29 08-8AB

**Insulation sleeves**

For flat connectors, connection from the front

3SB29 08-8AB

1 unit



3SB29 08-8AD

**Complete connectors<sup>2)</sup>**

For connecting contact blocks and lamp holders  
(up to 10 connections).  
Guaranteed finger-safe acc. to IEC 61140 and BGV A3.

3SB29 08-8AD

1 unit



3SB29 08-8AE

**Plug-in sleeves**

For flat connectors 2.8 × 0.8 mm,  
with locating spring for maintained in complete connector

3SB29 08-8AE

250 units

#### Tools



3SB29 08-2AA

**Dismantling tools**

For holders and lamp holders with holder

3SB29 08-2AA

1 unit



3SB29 08-2AC

**Mounting tools**

For buttons  
and screw lenses

3SB29 08-2AC

1 unit

<sup>1)</sup> Not suitable for EMERGENCY-STOP mushroom push buttons.

<sup>2)</sup> Required 3SB29 08-8AE plug-in sleeves for flat connectors 2.8 × 0.8 mm are not included in the scope of supply.



# Push Button Units and Indicator Lights

## 3SB2, Mounting Diameter 16 mm

### Dimension drawings (mm)

#### Actuators

**Pushbutton or illuminated pushbutton with flat button**

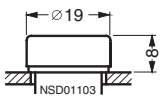

**Pushbutton or illuminated pushbutton with raised button**

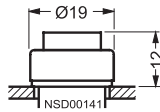

**Selector switch**

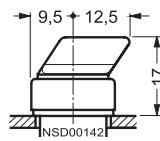

**CES key-operated switch**

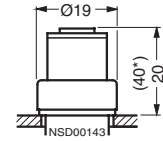

\* with key

**EMERGENCY-STOP mushroom pushbutton**

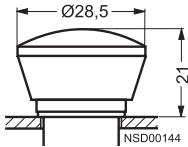

**Indicator light**

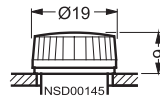

#### Contact blocks with push-on connection

**Pushbutton and contact block with holder for frontplate mounting**

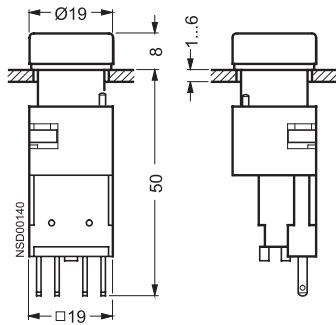

# Push Button Units and Indicator Lights

## 3SB2, Mounting Diameter 16 mm

### Dimension drawings (mm)

1

2

3

4

5

6

7

8

9

10

### Contact blocks with soldering pins for use on printed circuit boards

**Illuminated pushbutton unit**  
with contact block and lamp-  
holder with solder pins

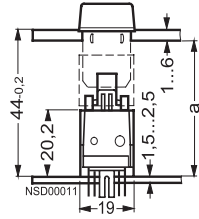

Length **a** of spacers:  $a = 44^{-0.2}$   
minus front plate thickness.  
When using backing plates, the length **a** is  
reduced by 0.8 mm.  
To avoid bending of the PCB when the actuator is  
operated, sufficient spacers must be provided  
spaced as shown in the table below:

Maximum PCB thickness	Max. distance between spacers
1.5 mm	80 mm
2.5 mm	150 mm
When using EMERGENCY-STOP actuators	generally 50 mm

### Solder pin spacing

Solder terminal  $\varnothing 1.3^{+0.1}$

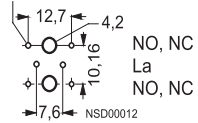

(These details are based on epoxy resin glass fibre mat.)

### Mounting dimensions

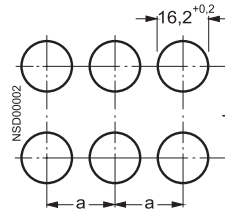

Minimum clearance	a	b
Round design	19	19
Square design without inscription plate	21	21
Round and square designs with 21 inscription plates	21	32
For 2 selector switches and 3 switching positions, maintained contact, side by side	21	21

### Accessories

#### Complete connector

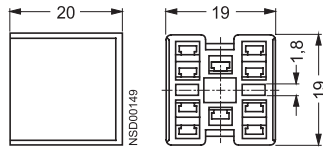

# Push Button Units and Indicator Lights

## SIRUS ACT 3SU Series

• Revised •  
08/31/15

### Overview

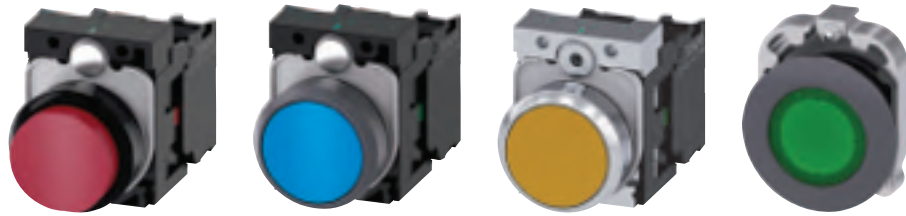

	3SU1.0	3SU1.3	3SU1.5	3SU1.6
<b>Pushbuttons and indicator lights</b>				
<b>Designs</b>				
Nominal diameter	22 mm	22 mm	22 mm	30 mm
Version	Plastic	Plastic with metal front ring, matte	Metal, shiny	Metal, matte, flat
<b>Actuators</b>				
Pushbuttons	✓	✓	✓	✓
Illuminated pushbuttons	✓	✓	✓	✓
Mushroom pushbuttons	✓	✓	✓	--
EMERGENCY STOP mushroom pushbuttons	✓	✓	✓	--
Selector switches	✓	✓	✓	✓
Key-operated switches	✓	✓	✓	✓
<b>Special actuators</b>				
Twin pushbuttons	✓	✓	✓	--
Coordinate switches	✓	✓	✓	--
Toggle switches	✓	✓	✓	--
Sensor switches	✓	✓	--	--
ID key-operated switches	✓	✓	--	--
Pushbuttons with extended stroke	✓	✓	✓	--
Potentiometers	✓	✓	✓	--
<b>Indicators</b>				
Indicator lights	✓	✓	✓	✓
Acoustic signaling devices	✓	✓	✓	--
<b>Contact modules</b>				
Single-pole	✓	✓	✓	✓
Two-pole	✓	✓	✓	✓
<b>LED modules</b>				
With integrated LED	✓	✓	✓	✓
<b>Connections</b>				
Screw terminals	✓	✓	✓	✓
Spring-type terminals	✓	✓	✓	✓
Solder pins	✓	✓	✓	✓
AS-Interface	✓	✓	✓	✓
IO-Link	✓	✓	✓	✓

- ✓ Standard
- Not available

Note:

Safety characteristics (see Appendix on page 10/147).



	3SU18	3SU18
	Enclosures	Two-hand operation consoles
<b>Enclosures</b>		
Plastic	✓	✓
Metal	✓	✓
<b>Actuators</b>		
Pushbuttons	✓	✓
Illuminated pushbuttons	✓	✓
Mushroom pushbuttons	✓	✓
EMERGENCY STOP mushroom pushbuttons	✓	✓
Selector switches	✓	✓
Key-operated switches	✓	✓
<b>Indicators</b>		
Indicator lights	✓	☐
Acoustic signaling devices	✓	☐
<b>Contact modules</b>		
Single-pole	✓	✓
Two-pole	--	✓
<b>Connections</b>		
Screw terminals	✓	✓
Spring-type terminals	✓	☐
Plug-in connection	☐	☐
AS-Interface	✓	☐

- ✓ Standard
- Not available
- ☐ Optional

### AS-Interface solutions

Pushbuttons and indicator lights of the SIRIUS ACT series can be connected to the AS-Interface communication system quickly and easily with the help of various solutions.

For AS-Interface solutions see catalog IK PI "Industrial Communication SIMATIC NET".

#### AS-Interface EMERGENCY STOP according to ISO 13850

Using special modules, EMERGENCY STOP devices according to ISO 13850 can be directly connected through the standard AS-Interface with safety-related communication (see page 10/108).

#### AS-Interface enclosures

Enclosures with standard fittings are listed in this catalog. For customized enclosures, use the SIRIUS ACT Configurator to select the elements for equipping (see page 10/116).

### PROFINET solutions

SIRIUS ACT devices will be equipped in future with a direct communication interface to PROFINET and PROFIsafe.

### RFID authentication solutions

Groups of employees or individuals can be authenticated by means of the ID key-operated switch. Color-coded keys for easy distinction between users and flexible in application thanks to four function stages.

### General data

#### Overview



SIRIUS ACT pushbuttons and indicator lights

#### **SIRIUS ACT – commanding and signaling**

SIRIUS ACT is a modular system of pushbuttons and indicator lights for front plate mounting and rear-mounted electrical modules.

#### Extensive portfolio

- Customized variants, e.g. special tumbler arrangements, labeling, equipped enclosures
- Communication-enabled thanks to direct interfacing to AS-Interface, IO-Link or PROFINET

#### Diverse possible applications

- National and international approvals
- Many trade approvals
- Short delivery times thanks to global availability

#### Standards

- IEC 60947-1, EN 60947-1
- IEC 60947-5-1, EN 60947-5-1
- IEC 60947-5-5, EN 60947-5-5 for EMERGENCY STOP devices

#### **Further information**

Home page, see [www.siemens.com/sirius-act](http://www.siemens.com/sirius-act)

Industry Mall, see [www.siemens.com/product?3SU1](http://www.siemens.com/product?3SU1)

Configurator, see [www.siemens.com/sirius-act/configurator](http://www.siemens.com/sirius-act/configurator)

Conversion tool, see [www.siemens.com/sirius/conversion-tool](http://www.siemens.com/sirius/conversion-tool)

Manual, see <https://support.industry.siemens.com/cs/ww/en/view/107542462>

#### **Configurator**



- Fast, simple selection by intuitive navigation through clearly-organized menus using drag & drop
- Image preview of selected components
- Inscription of pushbuttons and labeling plates using the interactive inscription tool
- Once created, a configuration can be ordered as often as required using the customer-specific article number and the CIN (Configuration Identification Number)
- Everything at a glance: Product data sheets, certificates, dimensional drawings, list prices, inscription tool



### Benefits

#### Design

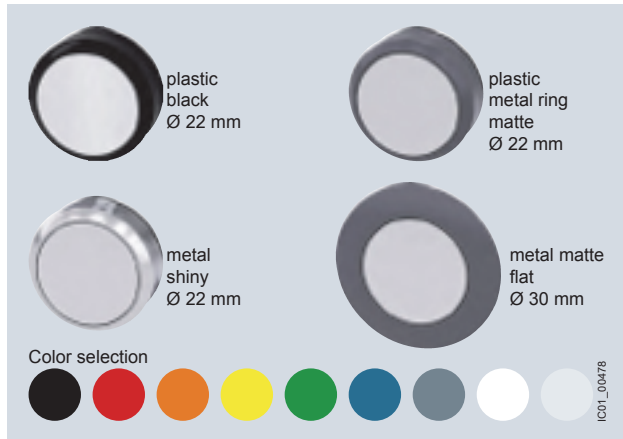

SIRIUS ACT is available in four design lines.

#### Ruggedness



- Degree of protection IP66, IP67, IP69 (IP69K)

#### IP66

6 = Protection against the ingress of dust

6 = Protection against powerful splash-water

#### IP67

6 = Protection against the ingress of dust

7 = Protection against temporary immersion

#### IP69 (IP69K)

6 = Protection against the ingress of dust

9/9K = Protection against water in high-pressure cleaning (approx. 80 bar) and high water jet temperatures (approx. 80 °C)

- Service life of 100 000 hours thanks to use of LEDs
- Media resistance (chemicals) thanks to solid stainless steel and high-grade plastics
- Mechanical endurance of  $10 \times 10^6$  switching cycles
- Suitable for use in extreme environments
- Reliable, friction-locked fixing with just one screw
- Design stability according to use
- Simple geometry for mounting holes

#### Communication



- Direct connection of the enclosure to AS-Interface or IO-Link
- Direct connection in the control cabinet to PROFINET, IO-Link or AS-Interface
- Can be integrated easily via the TIA Portal

#### Easy handling

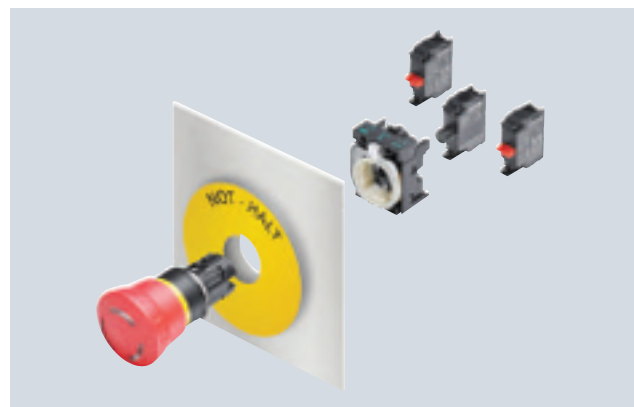

- Self-holding function of the actuator when mounting
- Twist prevention integrated into patented holder design
- Stackable contact modules
- Self-explanatory and fast installation using one hand
- Components can be mounted with holder removed
- No special tools required, simple size 2 screwdriver (cross-tip DIN ISO 87641PZD1, flat-head DIN ISO 2380-1 A/B 1x4.5) is sufficient

# Push Button Units and Indicator Lights

## SIRIUS ACT 3SU Series

• Revised •  
07/15/16

### General data

#### Mounting dimensions

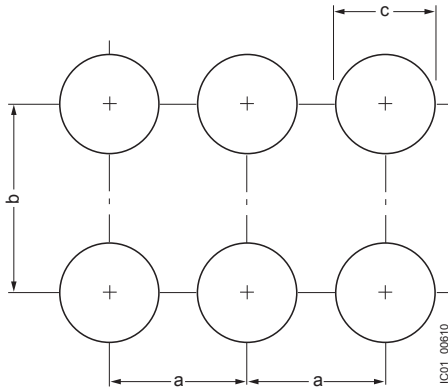

#### Versions

SIRIUS ACT is a modular system of pushbuttons and indicator lights with which customized variants can be configured flexibly.

One command point comprises:

- An actuating or signaling element in front of the control panel
- A holder for securing behind the control panel
- Up to six contact modules and/or one LED module (mounted onto the holder), single-pole contacts can be stacked
- A comprehensive range of accessories for inscription/markings

#### Complete units

Complete units made up of an actuating or signaling element, holder and contact modules and/or LED modules are offered for the most frequent application cases. The electrical parts are integrated and only have to be wired.

	Minimum clearance		
	a	b	c
	mm	mm	mm
<b>22 mm, plastic with metal front ring, matte</b>			
3-slot holder	30	40	22.3 <sup>+0.4</sup>
4-slot holder	40	40	22.3 <sup>+0.4</sup>
<b>30 mm, metal, matte</b>			
3-slot holder	40	45	30.5 <sup>+0.5</sup>

#### Compact units

Signaling devices, sensor switches, and pushbuttons with extended stroke are available as compact units. The electronic circuitry is already integrated in these devices, i.e. it is not necessary to snap on a contact or LED module.

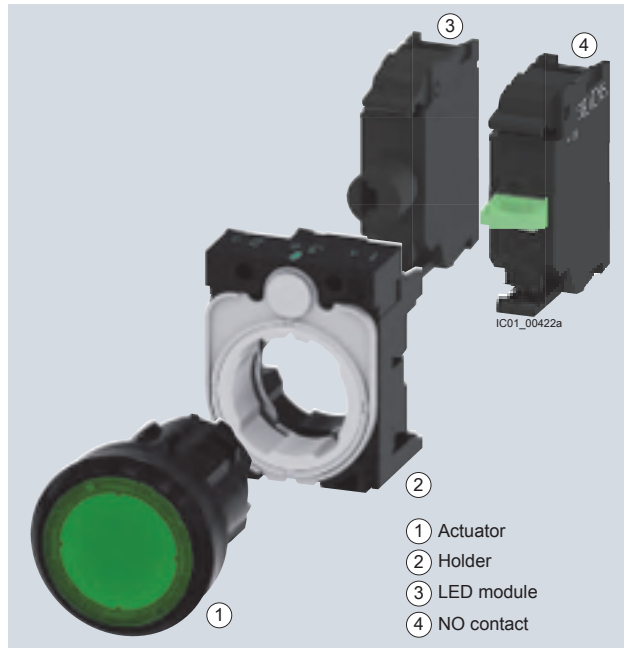

- 1 Actuator
- 2 Holder
- 3 LED module
- 4 NO contact

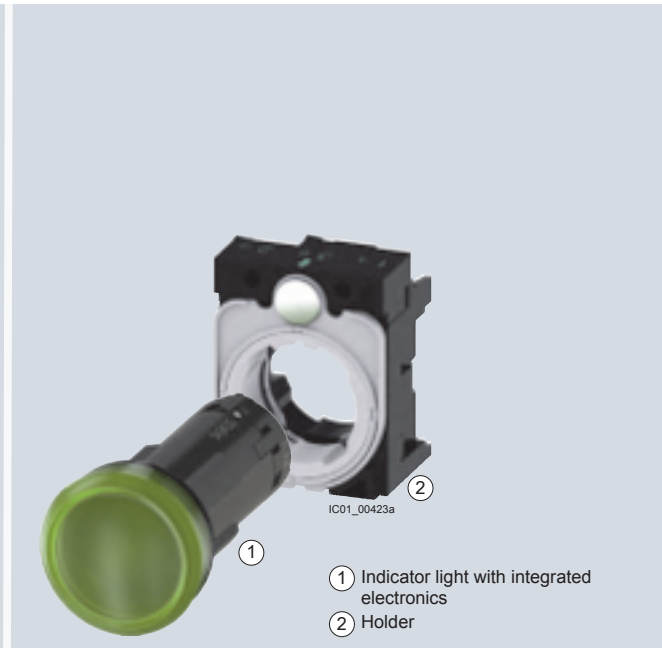

- 1 Indicator light with integrated electronics
- 2 Holder

Complete units	Pages	Compact units	Pages
Plastic, black	10/37	Plastic, black	10/43
Plastic with metal front ring, matte	10/57	Plastic with metal front ring, matte	10/63
Metal, shiny	10/77	Metal, shiny	10/83

### Actuating and signaling elements

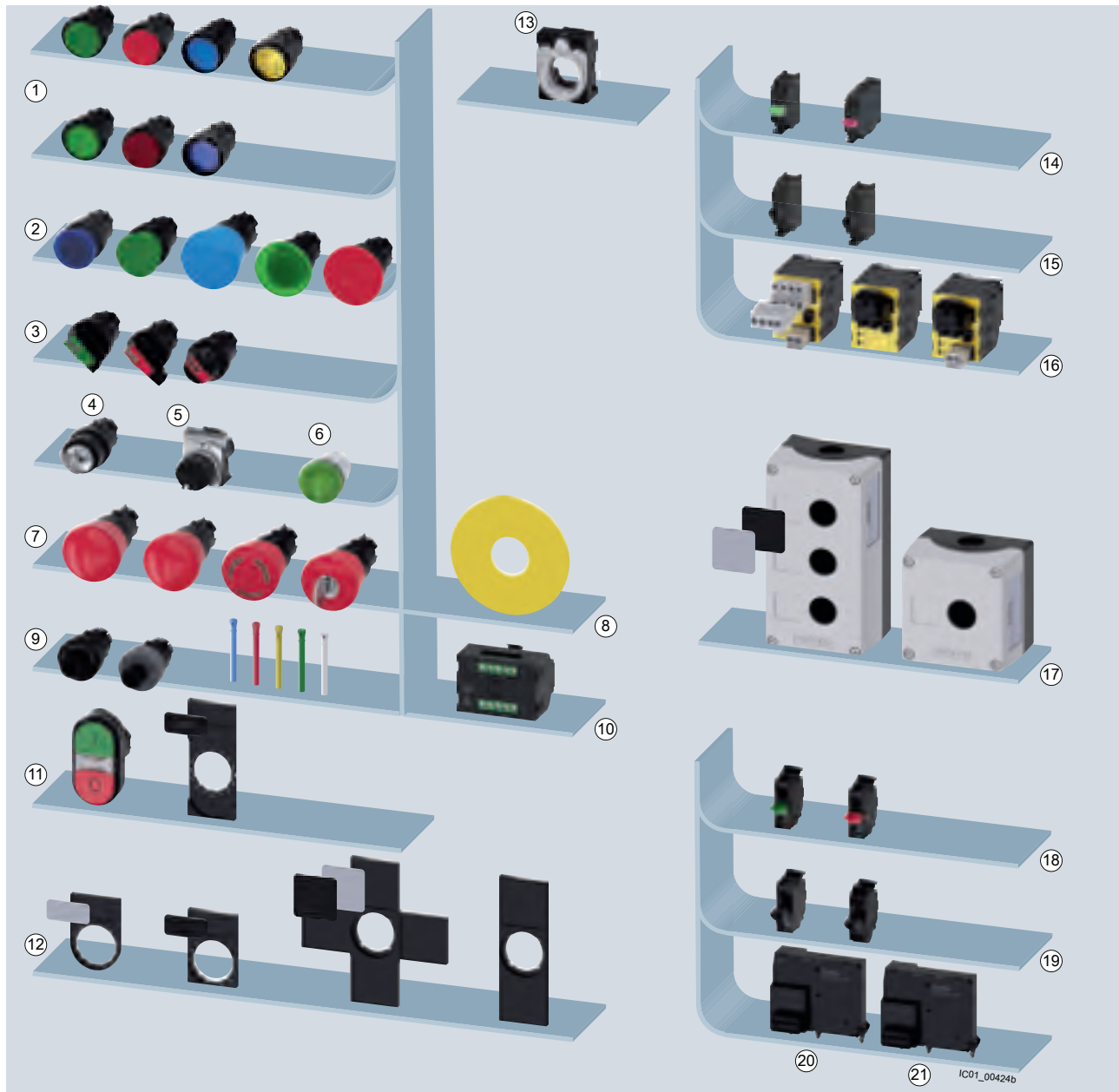

Actuating and signaling elements	Pages	Modules for front plate mounting	Pages
① Pushbuttons, illuminated pushbuttons	10/37	⑭ Contact modules	10/104
② Mushroom pushbuttons	10/39	⑮ LED modules	10/106
③ Selector switches	10/40	⑯ AS-Interface modules	10/108
④⑤⑥ Key-operated switches, potentiometers, indicator lights	10/41	<b>Enclosures</b>	<b>Pages</b>
⑦⑧ EMERGENCY STOP mushroom pushbuttons, backing plates	10/39	⑰ Enclosures	10/110
⑨⑩ ID key-operated switches, ID keys, electronic modules	10/55	<b>Modules for base mounting</b>	<b>Pages</b>
⑪ Twin pushbuttons, label holders, labeling plates	10/47	⑱ Contact modules	10/118
⑫ Label holders, labeling plates	10/122	⑳ LED modules	10/118
<b>Holders and labels</b>	<b>Pages</b>	㉑ IO-Link modules	10/120
⑬ Holders	10/122	㉒ AS-Interface modules	10/120

System overview of SIRIUS ACT pushbuttons and indicator lights from the plastic design line. Pushbuttons and indicator lights available in 4 design lines.

# Push Button Units and Indicator Lights

## SIRUS ACT 3SU Series

• Revised •  
07/15/16

### General data

#### ID key-operated switches

The ID key-operated switch is electronic and has 4 switch positions that are selected by keys with different codes. Using the 4 ID keys with different codes, it is possible to select 1 of 4 positions. The ID keys are color-coded (yellow, blue, red, green, white) so that they can be clearly differentiated at a glance.

Different versions of ID key-operated switches are available depending on the following features:

- Front ring material
- Conventional variant: 1 + 4 non-isolated outputs
- Variant with IO-Link: Option of individual coding

Operation:  
Insert ID key, turn key to select the position. Standard keys can also be used in conjunction with the electronic module for ID key-operated switches with IO-Link function. The white ID key is supplied without coding.



**3SU1000-4WS10-0AA0**  
Plastic, black



**3SU1030-4WS10-0AA0**  
Plastic with metal front ring, matte

ID key-operated switches		
Number of switching positions	4	4
Operating angle	45°	45°
Operating principle	Latching	Latching
Switch position for key removal	Key removal possible in all 4 positions	Key removal possible in all 4 positions
Color	Black	Black
Pages	<a href="#">10/55</a>	<a href="#">10/75</a>



**3SU1400-1GC10-1AA0**



**3SU1400-1GD10-1AA0**

Electronic modules for ID key-operated switches		
Type of power supply	--	via IO-Link master
Protocol is supported	--	IO-Link protocol
Number of NO contacts	5	5
IO-Link transfer rate	--	COM2 (38.4 Kbaud)
Pages	<a href="#">10/109</a>	<a href="#">10/109</a>



**3SU1900-0FU60-0AA0**









**3SU1900-0FV40-0AA0**  
**3SU1900-0FW30-0AA0**  
**3SU1900-0FX20-0AA0**  
**3SU1900-0FY50-0AA0**

ID keys		
Material	Plastic	Plastic
Version of RFID coding	Individually coded, programmable several times	ID group 1 ID group 2 ID group 3 ID group 4 Green Yellow Red Blue
Color	White	
Pages	<a href="#">10/143</a>	<a href="#">10/143</a>

**Article No. scheme**

Device types

						
<b>3SU10</b>	<b>3SU11</b>	<b>3SU12</b>	<b>3SU14</b>	<b>3SU15</b>	<b>3SU18</b>	<b>3SU19</b>
<b>Device types</b>						
<b>Actuating and signaling elements</b>	<b>Complete units</b>	<b>Compact units</b>	<b>Modules for actuators and indicators</b>	<b>Holders with module</b>	<b>Enclosures</b>	<b>Accessories</b>

Actuating and signaling elements

Product versions		Article number														
SIRIUS ACT pushbuttons and indicator lights		3SU1	<input type="checkbox"/>	<input type="checkbox"/>	<input type="checkbox"/>	-	<input type="checkbox"/>	<input type="checkbox"/>	<input type="checkbox"/>	<input type="checkbox"/>	<input type="checkbox"/>	-	<input type="checkbox"/>	<input type="checkbox"/>	<input type="checkbox"/>	
Device type	Actuating and signaling elements	0														
Material (front ring)	Plastic, black	0														
	Metal, matte (front ring)/ plastic, black (rosette)	3														
	Metal, shiny	5														
	Metal, matte	6														
Illumination	Non-illuminated	0														
	Illuminated/transparent	1														
	Illuminated/non illuminated	2														
Type of actuator/indicator	Pushbutton									0						
	Mushroom pushbutton/ EMERGENCY STOP mushroom									1						
	pushbutton/sensor switch									2						
	Selector switch									3						
	Twin pushbutton, toggle switch									4/5						
	Key-operated switch									6						
	Indicator light/acoustic signaling device Coordinate switch									7						
Design of the actuator/ acoustic signaling device	e.g. A = Flat										<input type="checkbox"/>					
Function	e.g. B = Momentary contact											<input type="checkbox"/>				
Color/key removal position	e.g. 10 = Black, 20 = Red												<input type="checkbox"/>	<input type="checkbox"/>		
Connection type	0 = None														<input type="checkbox"/>	
Module/holder equipment	e.g. A = without module, without holder Y = without module, with holder														<input type="checkbox"/>	
Marking	e.g. A = None, C = "I", D = "O", R = "R"														<input type="checkbox"/>	
Ambient condition	Standard, ATEX														0 1	
<b>Example</b>		<b>3SU1</b>	<b>0</b>	<b>0</b>	<b>0</b>	<b>-</b>	<b>0</b>	<b>A</b>	<b>B</b>	<b>1</b>	<b>0</b>	<b>-</b>	<b>0</b>	<b>A</b>	<b>A</b>	<b>0</b>

Note:

The Article No. scheme shows an overview of product versions for better understanding of the logic behind the article numbers.

For your orders please use the article numbers quoted in the selection and ordering data.

# Push Button Units and Indicator Lights

## SIRIUS ACT 3SU Series

• Revised •  
07/15/16

### General data

#### Complete units

Product versions		Article number														
SIRIUS ACT pushbuttons and indicator lights		3SU1	<input type="checkbox"/>	<input type="checkbox"/>	<input type="checkbox"/>	-	<input type="checkbox"/>	<input type="checkbox"/>	<input type="checkbox"/>	<input type="checkbox"/>	<input type="checkbox"/>	-	<input type="checkbox"/>	<input type="checkbox"/>	<input type="checkbox"/>	
Device type	Complete units	1														
Material (front ring)	Plastic, black	0														
	Metal, matte (front ring)/ plastic, black (rosette)	3														
	Metal, shiny	5														
	Metal, matte	6														
Illumination	Non-illuminated	0														
	Illuminated (with/without LED, various voltages)	1...8														
Type of actuator/indicator	Pushbutton	0														
	Mushroom pushbutton/EMERGENCY	1														
	STOP mushroom pushbutton/ sensor switch	2														
	Selector switch	3														
	Twin pushbutton, toggle switch	4/5														
	Key-operated switch	6														
	Indicator light/acoustic signaling device Coordinate switch	7														
Design of the actuator/acoustic signaling device	e.g. A = Flat						<input type="checkbox"/>									
Function	e.g. B = Momentary contact							<input type="checkbox"/>								
Color/key removal position	e. g. 10 = Black, 20 = Red								<input type="checkbox"/>	<input type="checkbox"/>						
Connection type	Screw terminals												1			
	Spring-type terminals												3			
Module/holder equipment incl. contact material	e. g.													<input type="checkbox"/>		
	A = Without module, with holder															
	B = 1 NO contact with holder															
	C = 1 NC contact with holder															
Marking	e.g. A = None, C = "I", D = "O", R = "R"													<input type="checkbox"/>		
Ambient condition	Standard														0	
	ATEX														1	
<b>Example</b>		<b>3SU1</b>	<b>1</b>	<b>0</b>	<b>0</b>	<b>-</b>	<b>0</b>	<b>A</b>	<b>A</b>	<b>1</b>	<b>0</b>	<b>-</b>	<b>1</b>	<b>B</b>	<b>A</b>	<b>0</b>

#### Compact units

Product versions		Article number														
SIRIUS ACT pushbuttons and indicator lights		3SU1	<input type="checkbox"/>	<input type="checkbox"/>	<input type="checkbox"/>	-	<input type="checkbox"/>	<input type="checkbox"/>	<input type="checkbox"/>	<input type="checkbox"/>	<input type="checkbox"/>	-	<input type="checkbox"/>	<input type="checkbox"/>	<input type="checkbox"/>	
Device type	Compact units	2														
Material (front ring)	Plastic, black	0														
	Metal, matte (front ring)/ plastic, black (rosette)	3														
	Metal, shiny	5														
	Metal, matte	6														
Illumination	Non-illuminated	0														
	Illuminated/non illuminated	1														
Type of actuator/indicator	Pushbutton	0														
	Sensor switch	1														
	Potentiometer	2														
	Indicator light/acoustic signaling device	6														
Design of the actuator/acoustic signaling device	e.g. A = Flat						<input type="checkbox"/>									
Function (voltage/resistance)	e.g. B = 24 V AC/DC							<input type="checkbox"/>								
Color	e. g. 10 = Black, 20 = Red								<input type="checkbox"/>	<input type="checkbox"/>						
Connection type	None													0		
	Screw terminals													1		
	M12 connection, 4-pole													2		
	Spring-type terminals													3		
Module/holder equipment incl. contact material	e. g.														<input type="checkbox"/>	
	A = Without module, without holder															
	B = 1 NO contact with holder															
	C = 1 NC contact with holder															
Marking	e.g. A = none													<input type="checkbox"/>		
Ambient condition	Standard														0	
	ATEX														1	
<b>Example</b>		<b>3SU1</b>	<b>2</b>	<b>0</b>	<b>1</b>	<b>-</b>	<b>6</b>	<b>A</b>	<b>B</b>	<b>0</b>	<b>0</b>	<b>-</b>	<b>1</b>	<b>A</b>	<b>A</b>	<b>0</b>

#### Note:

The Article No. scheme shows an overview of product versions for better understanding of the logic behind the article numbers.

For your orders please use the article numbers quoted in the selection and ordering data.

### Modules for actuators and indicators

Product versions		Article number														
SIRIUS ACT pushbuttons and indicator lights		3SU1	<input type="checkbox"/>	<input type="checkbox"/>	<input type="checkbox"/>	-	<input type="checkbox"/>	<input type="checkbox"/>	<input type="checkbox"/>	<input type="checkbox"/>	<input type="checkbox"/>	-	<input type="checkbox"/>	<input type="checkbox"/>	<input type="checkbox"/>	
Device type	Modules for actuators and indicators	4														
Material (front ring)	Plastic, black	0														
Illumination	Non-illuminated	0														
	Illuminated	1														
Type of mounting	Front plate mounting						1									
	Base mounting						2									
	Printed circuit board						3									
Module type	Contact module								A							
	LED module								B							
	LED test module								C							
	Support terminal								D							
	AS-Interface module								E							
	Electronic module for ID key-operated switches								G							
Function/voltage	e.g. B = 24 V AC/DC								<input type="checkbox"/>							
Color	e. g. 10 = Black, 20 = Red								<input type="checkbox"/>	<input type="checkbox"/>						
Connection type	Screw terminals													1		
	Screw terminals + insulation piercing method													2		
	Spring-type terminals													3		
	Spring-type terminals + insulation piercing method													4		
	Socket terminals													5		
Module equipment incl. contact material	e. g. A = None B = 1 NO contact, silver C = 1 NC contact, silver												<input type="checkbox"/>			
Marking	None													A		
Ambient condition	Standard ATEX														0 1	
<b>Example</b>		<b>3SU1</b>	<b>4</b>	<b>0</b>	<b>0</b>	<b>-</b>	<b>1</b>	<b>A</b>	<b>A</b>	<b>1</b>	<b>0</b>	<b>-</b>	<b>1</b>	<b>B</b>	<b>A</b>	<b>0</b>

### Holders

Product versions		Article number														
SIRIUS ACT pushbuttons and indicator lights		3SU1	<input type="checkbox"/>	<input type="checkbox"/>	<input type="checkbox"/>	-	<input type="checkbox"/>	<input type="checkbox"/>	<input type="checkbox"/>	<input type="checkbox"/>	<input type="checkbox"/>	-	<input type="checkbox"/>	<input type="checkbox"/>	<input type="checkbox"/>	
Device type	Holder	5														
Material (front ring)	Plastic, black	0														
	Metal, shiny	5														
Illumination	Non-illuminated	0														
	Illuminated	1														
Type of mounting	None						0									
	Front plate mounting						1									
Holder type	3x A								A							
	4x B								B							
Function/voltage	None 6 ... 24 V AC/DC								A G							
Color	e.g. 10 = Black, 20 = Red								<input type="checkbox"/>	<input type="checkbox"/>						
Connection type	None													0		
	Screw terminals													1		
Module equipment incl. contact material and slot	e. g. A = None B = 1 NO contact, silver C = 1 NC contact, silver												<input type="checkbox"/>			
Marking	None													A		
Ambient condition	Standard ATEX														0 1	
<b>Example</b>		<b>3SU1</b>	<b>5</b>	<b>0</b>	<b>0</b>	<b>-</b>	<b>0</b>	<b>A</b>	<b>A</b>	<b>1</b>	<b>0</b>	<b>-</b>	<b>0</b>	<b>A</b>	<b>A</b>	<b>0</b>

### Note:

The Article No. scheme shows an overview of product versions for better understanding of the logic behind the article numbers.

For your orders please use the article numbers quoted in the selection and ordering data.

# Push Button Units and Indicator Lights

## SIRIUS ACT 3SU Series

• Revised •  
07/15/16

### General Data

#### Enclosures

Product versions		Article number														
SIRIUS ACT pushbuttons and indicator lights		3SU1	<input type="checkbox"/>	<input type="checkbox"/>	<input type="checkbox"/>	-	<input type="checkbox"/>	<input type="checkbox"/>	<input type="checkbox"/>	<input type="checkbox"/>	<input type="checkbox"/>	-	<input type="checkbox"/>	<input type="checkbox"/>	<input type="checkbox"/>	
Device type	8 = Enclosure	8														
Material (enclosure/front ring)	Plastic / black plastic Metal, shiny metal	0 5														
Number of command points	1 command point ... 6 command points	1 ... 6														
Type of enclosure	Configuration 4-position selector switches and coordinate switches Palm pushbutton Two-hand operation console	0 1 2 3														
Equipment	e.g. command point, inscription, module						<input type="checkbox"/>	<input type="checkbox"/>								
Communication capability	None AS-i									0 1						
Ambient condition	Standard ATEX										0 1					
Mounting/ connection of modules	None Front plate mounting, screw terminals Base mounting, screw terminals Base mounting, spring-type terminals												0 1 2 3			
Cable exit from enclosure	None Direct entry of AS-i flat cable at top/on right AS-i insulation piercing method at top/ on right													A G H		
Design of enclosure top	Center command point With recess for labeling plate With protective collar 4 additional holes (two-hand operation console) 8 additional premachined breaking points (two-hand operation console)													A B C D E		
Color of enclosure top	Gray Yellow														8	
<b>Example</b>		<b>3SU1</b>	<b>8</b>	<b>0</b>	<b>1</b>	<b>-</b>	<b>0</b>	<b>A</b>	<b>A</b>	<b>0</b>	<b>0</b>	<b>-</b>	<b>0</b>	<b>A</b>	<b>A</b>	<b>2</b>

#### Accessories

Product versions		Article number														
SIRIUS ACT Pushbuttons and Indicator Lights		3SU1	<input type="checkbox"/>	<input type="checkbox"/>	<input type="checkbox"/>	-	<input type="checkbox"/>	<input type="checkbox"/>	<input type="checkbox"/>	<input type="checkbox"/>	<input type="checkbox"/>	-	<input type="checkbox"/>	<input type="checkbox"/>	<input type="checkbox"/>	
Device type	Accessories	9														
Material	Plastic, black Metal/plastic Metal, shiny Metal, matte	0 3 5 6														
Illumination	Non-illuminated Illuminated	0 1														
Type of accessory (labels, protection, actuator, enclosure)	e. g. 0AB = Insert label						<input type="checkbox"/>	<input type="checkbox"/>	<input type="checkbox"/>							
Color	e. g. 10 = Black, 20 = Red									<input type="checkbox"/>	<input type="checkbox"/>					
Marking	e. g. 0AA = None 0AB = ON 0AT = EMERGENCY STOP												<input type="checkbox"/>	<input type="checkbox"/>	<input type="checkbox"/>	
Ambient condition	Standard ATEX														0 1	
<b>Example</b>		<b>3SU1</b>	<b>9</b>	<b>0</b>	<b>0</b>	<b>0</b>	<b>0</b>	<b>A</b>	<b>B</b>	<b>7</b>	<b>1</b>	<b>0</b>	<b>0</b>	<b>A</b>	<b>B</b>	<b>0</b>

#### Note:

The Article No. scheme shows an overview of product versions for better understanding of the logic behind the article numbers.

For your orders please use the article numbers quoted in the selection and ordering data.



### Benefits

#### Advantages through energy efficiency

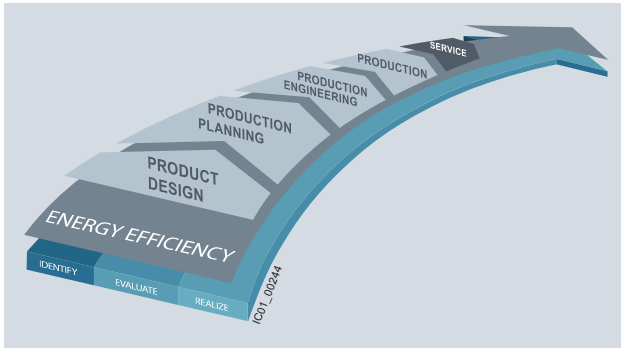

Energy management in industry

#### Overview of the energy management process

We offer you a unique portfolio for efficient energy management in the industry – a process that is used to optimize the energy requirements. We divide operational energy management into the three phases: identification, evaluation and implementation, and support you with suitable hardware and software solutions in each phase of the process.

The innovative products of the SIRIUS industrial controls portfolio can also make a substantial contribution to a plant's energy efficiency (see [www.siemens.com/sirius/energysaving](http://www.siemens.com/sirius/energysaving)).

SIRIUS ACT pushbuttons and indicator lights contribute to energy efficiency throughout the plant as follows:

- Lower power consumption by means of LED technology
- Long service life

### Application

#### Environmental conditions

The pushbuttons and indicator lights are climate-proof (KTW 24) and suitable for standard industrial applications and operation in marine applications.

#### Safety EMERGENCY STOP pushbuttons according to ISO 13850

For controls according to IEC 60204-1 or EN 60204-1, the SIRIUS ACT mushroom pushbuttons are suitable for use as safety EMERGENCY STOP pushbuttons.

#### Safety circuits

IEC 60947-5-1 and EN 60947-5-1 require positive opening. This means that for the purpose of personal safety, the reliable opening of NC contacts in all safety circuits is expressly prescribed for the electrical equipment of machines and is designated according to IEC 60947-5-1 with the symbol (⊖).

Category 4 according to EN ISO 13849-1 can be attained with the EMERGENCY STOP mushroom pushbuttons if the corresponding fail-safe evaluation units are selected and correctly installed, e.g. the 3SK11 safety relays or the 3RK3 Modular Safety System (see page 11/1 onwards) or matching units from the ASIsafe, SIMATIC or SINUMERIK product ranges.

The SIRIUS ACT pushbuttons and indicator lights can be connected to the AS-Interface communication system quickly and safely.

The following solutions are available:

- AS-Interface modules
- AS-Interface module in safety-related version for EMERGENCY STOP mushroom pushbutton
- Ready-fitted AS-Interface enclosures with 1 to 6 command points

#### IO-Link

The SIRIUS ACT pushbuttons and indicator lights can be connected to IO-Link quickly and safely. The connection is made via a special IO-Link-module.

# Push Button Units and Indicator Lights

## SIRUS ACT 3SU Series

• Revised •  
07/15/16

### General Data

#### Technical specifications

Type	3SU1..0-AA 3SU1..0-JA		3SU1..1-AA 3SU1..1-JA		3SU1..0-AB 3SU1..0-BB 3SU1..0-CB 3SU1..0-DB 3SU1..0-JB		3SU1..1-AB 3SU1..1-BB 3SU1..1-JB			
Product version	<b>Pushbuttons</b>									
Operating principle of the actuating element	Latching				Momentary contact					
Optional expansion of product by light source	No		Yes		No		Yes			
Mechanical endurance (operating cycles) typical	500 000				10 000 000		3 000 000			
Switching frequency maximum	1/h	1 800			3 600					
Shock resistance acc. to IEC 60068-2-27	Half-sine wave 50 g / 11 ms									
Vibration resistance acc. to IEC 60068-2-6	10 ... 500 Hz: 5 g									
IP degree of protection	IP66, IP67, IP69 (IP69K)									
Environmental category during operation according to IEC 60721	3M6, 3S2, 3B2, 3C3, 3K6 (with a relative air humidity of 10 ... 95%)									
Ambient temperature										
• During operation	°C	-25 ... +70								
• During storage	°C	-40 ... +80								
Type	3SU1.00-AA 3SU1.00-BA 3SU1.00-CA 3SU1.30-AA 3SU1.30-BA 3SU1.50-AA 3SU1.50-BA 3SU1.50-CA		3SU1.50-EA		3SU1.01-AA 3SU1.01-BA 3SU1.51-AA 3SU1.51-BA 3SU1.51-CA		3SU1.00-AD 3SU1.00-BD 3SU1.00-CD 3SU1.30-AD 3SU1.30-BD 3SU1.50-AD 3SU1.50-BD 3SU1.50-CD		3SU1.50-ED 3SU1.01-AD 3SU1.01-BD 3SU1.31-AD 3SU1.31-BD	
Product version	<b>Mushroom pushbuttons</b>									
Operating principle of the actuating element	Latching					Momentary contact				
Optional expansion of product by light source	No			Yes		No			Yes	
Mechanical endurance (operating cycles) typical	500 000		300 000		500 000		10 000 000		3 000 000	
Switching frequency maximum	1/h	1 800			3 600			1 800		3 600
Shock resistance acc. to IEC 60068-2-27	Half-sine wave 50 g / 11 ms									
Vibration resistance acc. to IEC 60068-2-6	10 ... 500 Hz: 5 g									
IP degree of protection	IP66, IP67, IP69 (IP69K)		IP65, IP67, IP69 (IP69K)		IP66, IP67, IP69 (IP69K)			IP65, IP67, IP69 (IP69K)		IP66, IP67, IP69 (IP69K)
Environmental category during operation according to IEC 60721	3M6, 3S2, 3B2, 3C3, 3K6 (with a relative air humidity of 10 ... 95%)									
Ambient temperature										
• During operation	°C	-25 ... +70								
• During storage	°C	-40 ... +80								
Type	3SU1...-J 3SU1...-H 3SU1...-G									
Product version	<b>EMERGENCY STOP mushroom pushbuttons</b>									
Mechanical endurance (operating cycles)	300 000									
Switching frequency maximum	1/h	600								
Shock resistance acc. to IEC 60068-2-27	Half-sine wave 50 g / 11 ms									
Vibration resistance acc. to IEC 60068-2-6	10 ... 500 Hz: 5 g									
IP degree of protection	IP66, IP67, IP69 (IP69K)									
Environmental category during operation according to EN 60721	3M6, 3S2, 3B2, 3C3, 3K6 (with a relative air humidity of 10 ... 95%)									
Ambient temperature										
• During operation	°C	-25 ... 70								
• During storage	°C	-40 ... 80								

<sup>1)</sup> UL NEMA rating for twin pushbuttons (all types) – NEMA Type: 1, 2, 3, 3R, 4, 4X

• Revised •  
07/15/16

# Push Button Units and Indicator Lights

## SIRUS ACT 3SU Series

### General data

1  
2  
3  
4  
5  
6  
7  
8  
9  
10



Type	3SU1.5.-2A 3SU1.5.-2B 3SU1.5.-2C 3SU1.5.-2D 3SU1.5.-2E	3SU1.0.-2A 3SU1.0.-2B 3SU1.0.-2C 3SU1.3.-2A 3SU1.3.-2B 3SU1.3.-2C	3SU1.0.-3E 3SU1.3.-3E 3SU1.5.-3E	3SU1.0.-4B 3SU1.0.-4C 3SU1.0.-4D 3SU1.0.-4F 3SU1.0.-4G 3SU1.0.-4H 3SU1.0.-4J 3SU1.0.-4L 3SU1.0.-5B 3SU1.0.-5H 3SU1.0.-5P 3SU1.0.-5Q 3SU1.0.-5R 3SU1.0.-5S 3SU1.0.-5T 3SU1.0.-5X	3SU1...-4B 3SU1...-4C 3SU1...-4D 3SU1...-4F 3SU1...-4G 3SU1...-4H 3SU1...-4J 3SU1...-4L 3SU1...-5B 3SU1...-5H 3SU1...-5K 3SU1...-5L 3SU1...-5P 3SU1...-5Q 3SU1...-5R 3SU1...-5S 3SU1...-5T 3SU1...-5X	3SU1.0.-7A 3SU1.0.-7B 3SU1.3.-7A 3SU1.3.-7B 3SU1.5.-7A 3SU1.5.-7B
Product version	Selector switches		Toggle switches	Key-operated switches		Coordinate switches
<b>Mechanical endurance (operating cycles)</b>	300 000	1 000 000			300 000	250 000
<b>Switching frequency maximum</b>	1/h	1 800				3 600
<b>Shock resistance</b> acc. to IEC 60068-2-27	Half-sine wave 50 g / 11 ms					
<b>Vibration resistance</b> acc. to IEC 60068-2-6	10 ... 500 Hz: 5 g					
<b>IP degree of protection</b>	IP66, IP67, IP69 (IP69K)		IP66, IP67, IP69K	IP66, IP67, IP69 (IP69K)		IP65, IP67
<b>Ambient temperature</b>						
• During operation	°C	-25 ... +70				
• During storage	°C	-40 ... +80				
Type	3SU1400- .AA101-.A0	3SU1400- 1AA101-GA0, 3SU1400- 1AA101-RA0	3SU1400- 1AA101-HA0	3SU1400- .AA103-.A0	3SU1400- 1AA103-GA0, 3SU1400- 1AA103-RA0	3SU1400- 1AA103-HA0 3AA105-.A0
Product version	Contact modules					
<b>Rated insulation voltage</b>	V	500				
<b>Pollution degree</b>		3				
<b>Impulse withstand voltage</b>	kV	6				
<b>Rated value</b>						
<b>Operational voltage type</b>		AC/DC				
<b>Operational voltage, rated value</b>						
• At AC at 50 Hz	V	5 ... 500				
• At DC	V	5 ... 500				
<b>Thermal current</b>	A	10				
<b>Operational current, rated value</b>						
• At AC-12						
- At 24 V	A	10				
- At 230 V	A	8				
• At AC-15						
- At 24 V	A	6				
- At 230 V	A	6	4	6	4	6
- At 400 V	A	3				
- At 500 V	A	1.4				
• At DC-12						
- At 24 V	A	10				
- At 48 V	A	5				
- At 110 V	A	2.5				
- At 230 V	A	1	0.3	1	0.3	1
- At 400 V	A	0.3				
- At 500 V	A	0.3	0.2	0.3		
• At DC-13						
- At 24 V	A	3				
- At 48 V	A	1.5				
- At 110 V	A	0.7	0.6	0.7	0.6	0.7
- At 230 V	A	0.3				
- At 400 V	A	0.1				
- At 500 V	A	0.1				
<b>Contact reliability</b>		One contact failure per 100 million (17 V, 5 mA), one contact failure per 10 million (5 V, 1 mA)				
<b>Mechanical endurance (operating cycles) typical</b>		10 000 000				



# Push Button Units and Indicator Lights

## SIRUS ACT 3SU Series

• Revised •  
07/15/16

### General data

Type	3SU1400- .AA101-.A0	3SU1400- 1AA101-GA0, 3SU1400- 1AA101-RA0	3SU1400- 1AA101-HA0	3SU1400- .AA103-.A0	3SU1400- 1AA103-GA0, 3SU1400- 1AA103-RA0	3SU1400- 1AA103-HA0	3SU1400- 3AA105-.A0	
Product version	<b>Contact modules</b>							
<b>Switching frequency maximum</b>	1/s	3600						
<b>Fuse link version required for short-circuit protection of the auxiliary switch with type of coordination 1</b>	gG / Dz 10 A, quick-response / Dz 10 A							
<b>Continuous current of miniature circuit breaker C characteristic</b>	A	10						
<b>Vibration resistance</b> acc. to IEC 60068-2-6	10 ... 500 Hz: 5 g							
<b>Shock resistance</b> acc. to IEC 60068-2-27	Half-sine wave 50 g / 11 ms							
<b>Climate class during operation</b> according to EN 60721	3M6, 3S2, 3B2, 3C3, 3K6 (with a relative air humidity of 10 ... 95%, no condensation permitted in operation)							
<b>Ambient temperature</b>		<ul style="list-style-type: none"> <li>• During operation °C -25 ... +70</li> <li>• During storage °C -40 ... +80</li> </ul>						
<b>IP degree of protection</b>		<ul style="list-style-type: none"> <li>• of the enclosure IP40</li> <li>• of the terminal IP20</li> </ul>						
<b>Type of electrical connection</b>	<b>Screw terminals</b> 		<b>Spring-type terminals</b> 			<b>Socket terminals (THT)</b> 		
<b>Type of connectable conductor cross-sections</b>								
• Solid with end sleeve	2 x (0.5 ... 0.75 mm <sup>2</sup> )		--			--		
• Solid without end sleeve	2 x (1.0 ... 1.5 mm <sup>2</sup> )		2 x (0.25 ... 1.5 mm <sup>2</sup> )			--		
• Finely stranded with end sleeve	2 x (0.5 ... 1.5 mm <sup>2</sup> )		2 x (0.25 ... 0.75 mm <sup>2</sup> )			--		
• Finely stranded without end sleeve	2 x (1.0 ... 1.5 mm <sup>2</sup> )		2 x (0.25 ... 1.5 mm <sup>2</sup> )			--		
• For AWG cables	2 x (18 ... 14)		2 x (24 ... 16)			--		
<b>Tightening torque</b> for screw terminals	Nm	0.8 ... 0.9		--			--	

Type	3SU1401-.....-1	3SU1401-.....-3	3SU1401-.....-5
Product version	<b>LED module</b>		
<b>Light source integrated in product</b>	Yes		
<b>Type of light source</b>	LED		
<b>Rated insulation voltage</b>	V	320	
<b>Pollution degree</b>	3		
<b>Rated impulse withstand voltage</b>	kV	4	
<b>Relative positive tolerance of the operational voltage</b>	%	20	
<b>Relative negative tolerance of the operational voltage</b>	%	20	
<b>Operating time typical</b>	h	100 000	
<b>Vibration resistance</b> acc. to IEC 60068-2-6	10 ... 500 Hz: 5 g		
<b>Shock resistance</b> acc. to IEC 60068-2-27	Half-sine wave 50 g / 11 ms		
<b>Environmental category during operation</b> according to IEC 60721	3M6, 3S2, 3B2, 3K6 (with a relative air humidity of 10 ... 95%, no condensation permitted in operation)		
<b>Ambient temperature</b>		<ul style="list-style-type: none"> <li>• During operation °C -25 ... +70</li> <li>• During storage °C -40 ... +80</li> </ul>	
<b>IP degree of protection of the terminal</b>	IP20		
<b>Type of electrical connection</b>	<b>Screw terminals</b> 	<b>Spring-type terminals</b> 	<b>Socket terminals (THT)</b> 

For further information in the Manual, see <https://support.industry.siemens.com/cs/ww/en/view/107542462>.

• Revised •  
08/31/15

# Push Button Units and Indicator Lights

## 3SU1 22 mm, Round, Plastic, Black — Complete Units

Pushbuttons

1  
2  
3  
4  
5  
6  
7  
8  
9  
10

### Selection and ordering data

Supply voltage for light source		Color	Number of NO contacts	Number of NC contacts	DT	Screw terminals	⊕	PU (UNIT, SET, M)	PS*
At AC	At DC								
V	V					Order No.			

#### Pushbuttons

##### Pushbuttons with flat button, momentary contact



3SU1100-0AB40-1BA0

--	--	Black	1	0	▶	3SU1100-0AB10-1BA0		1	1 unit
			0	1	▶	3SU1100-0AB10-1CA0		1	1 unit
		Red	1	0	A	3SU1100-0AB20-1BA0		1	1 unit
			0	1	▶	3SU1100-0AB20-1CA0		1	1 unit
		Yellow	1	0	B	3SU1100-0AB30-1BA0		1	1 unit
		Green	1	0	▶	3SU1100-0AB40-1BA0		1	1 unit
		Blue	1	0	A	3SU1100-0AB50-1BA0		1	1 unit
		White	1	0	A	3SU1100-0AB60-1BA0		1	1 unit
		Clear	1	0	B	3SU1100-0AB70-1BA0		1	1 unit

##### Pushbuttons with raised button, momentary contact



3SU1100-0BB20-1CA0

--	--	Black	0	1	B	3SU1100-0BB10-1CA0		1	1 unit
		Red	0	1	▶	3SU1100-0BB20-1CA0		1	1 unit
		Blue	1	0	B	3SU1100-0BB50-1BA0		1	1 unit

##### Illuminated pushbuttons with flat button, momentary contact with integrated LED



3SU1102-0AB40-1BA0

24	24	Red	1	0	B	3SU1102-0AB20-1BA0		1	1 unit
			0	1	▶	3SU1102-0AB20-1CA0		1	1 unit
		Yellow	1	0	▶	3SU1102-0AB30-1BA0		1	1 unit
		Green	1	0	▶	3SU1102-0AB40-1BA0		1	1 unit
		Blue	1	0	A	3SU1102-0AB50-1BA0		1	1 unit
		White	1	0	A	3SU1102-0AB60-1BA0		1	1 unit
		Clear	1	0	A	3SU1102-0AB70-1BA0		1	1 unit



3SU1103-0AB20-1CA0

110	--	Red	0	1	B	3SU1103-0AB20-1CA0		1	1 unit
		Yellow	1	0	B	3SU1103-0AB30-1BA0		1	1 unit
		Green	1	0	B	3SU1103-0AB40-1BA0		1	1 unit
		Blue	1	0	B	3SU1103-0AB50-1BA0		1	1 unit
		White	1	0	B	3SU1103-0AB60-1BA0		1	1 unit
		Clear	1	0	B	3SU1103-0AB70-1BA0		1	1 unit

# Push Button Units and Indicator Lights

## 3SU1 22 mm, Round, Plastic, Black — Complete Units

• Revised •  
08/31/15

### Pushbuttons

Supply voltage for light source		Color	Number of NO contacts	Number of NC contacts	DT	Screw terminals 	PU (UNIT, SET, M)	PS*
At AC	At DC							
V	V					Order No.		

#### Pushbuttons

##### Illuminated pushbuttons with flat button, momentary contact with integrated LED



3SU1106-0AB40-1BA0

230	--	Red	0	1	B	3SU1106-0AB20-1CA0	1	1 unit
		Yellow	1	0	B	3SU1106-0AB30-1BA0	1	1 unit
		Green	1	0	B	3SU1106-0AB40-1BA0	1	1 unit
		Blue	1	0	B	3SU1106-0AB50-1BA0	1	1 unit
		White	1	0	B	3SU1106-0AB60-1BA0	1	1 unit
		Clear	1	0	B	3SU1106-0AB70-1BA0	1	1 unit

##### Spring-type terminals

##### Pushbuttons with flat button, momentary contact



3SU1100-0AB30-3BA0

--	--	Black	1	0	B	3SU1100-0AB10-3BA0	1	1 unit
			0	1	B	3SU1100-0AB10-3CA0	1	1 unit
		Red	0	1	B	3SU1100-0AB20-3CA0	1	1 unit
		Yellow	1	0	B	3SU1100-0AB30-3BA0	1	1 unit
		Green	1	0	B	3SU1100-0AB40-3BA0	1	1 unit
		Blue	1	0	B	3SU1100-0AB50-3BA0	1	1 unit
		White	1	0	B	3SU1100-0AB60-3BA0	1	1 unit

##### Illuminated pushbuttons with flat button, momentary contact with integrated LED



3SU1102-0AB20-3CA0

24	24	Red	0	1	B	3SU1102-0AB20-3CA0	1	1 unit
		Yellow	1	0	B	3SU1102-0AB30-3BA0	1	1 unit
		Green	1	0	B	3SU1102-0AB40-3BA0	1	1 unit
		Blue	1	0	B	3SU1102-0AB50-3BA0	1	1 unit
		White	1	0	B	3SU1102-0AB60-3BA0	1	1 unit
		Clear	1	0	B	3SU1102-0AB70-3BA0	1	1 unit

110	--	Red	0	1	B	3SU1103-0AB20-3CA0	1	1 unit
		Green	1	0	B	3SU1103-0AB40-3BA0	1	1 unit
		White	1	0	B	3SU1103-0AB60-3BA0	1	1 unit
		Clear	1	0	B	3SU1103-0AB70-3BA0	1	1 unit

230	--	Red	0	1	B	3SU1106-0AB20-3CA0	1	1 unit
		Green	1	0	B	3SU1106-0AB40-3BA0	1	1 unit
		White	1	0	B	3SU1106-0AB60-3BA0	1	1 unit
		Clear	1	0	B	3SU1106-0AB70-3BA0	1	1 unit

• Revised •  
07/15/16

# Push Button Units and Indicator Lights

## 3SU1 22 mm, Round, Plastic, Black — Complete Units

### Mushroom pushbuttons / EMERGENCY STOP mushroom pushbuttons

1  
2  
3  
4  
5  
6  
7  
8  
9  
10

#### Selection and ordering data

Unlatching method	Number of NO contacts	Number of NC contacts	DT	Screw terminals	PU (UNIT, SET, M)	PS*
				⊕		
				Order No.		

#### Mushroom pushbuttons

##### With red mushroom, diameter 40 mm, latching



3SU1100-1BA20-3CA0

Pull to unlatch	0	1	▶	3SU1100-1BA20-1CA0	1	1 unit
				Spring-type terminals	⊕	
Pull to unlatch	0	1	B	3SU1100-1BA20-3CA0	1	1 unit

#### Selection and ordering data

Unlatching method	Number of NO contacts	Number of NC contacts	Marking	DT	Screw terminals	PU (UNIT, SET, M)	PS*
					⊕		
				Order No.			

#### EMERGENCY STOP mushroom pushbuttons, tamper-proof, in accordance with ISO 13850 and IEC 60947-5-5

##### With red mushroom, diameter 40 mm, with positive latching



3SU1100-1HA20-1CH0

Pull to unlatch	0	1	NOT-HALT	↻	B	3SU1100-1HA20-1CH0	1	1 unit
-----------------	---	---	----------	---	---	--------------------	---	--------



3SU1100-1HB20-1CG0

Rotate to unlatch	0	1	None	↻	B	3SU1100-1HB20-1CF0	1	1 unit
	0	1	EMERGENCY STOP	↻	▶	3SU1100-1HB20-1CG0	1	1 unit
	1	1	EMERGENCY STOP	↻	B	3SU1100-1HB20-1FG0	1	1 unit



3SU1100-1HB20-3CH0

						Spring-type terminals	⊕	
Rotate to unlatch	0	1	NOT-HALT	↻	▶	3SU1100-1HB20-3CH0	1	1 unit

↻ Positive opening according to IEC 60947-5-1, Appendix K.  
Can be used with 3SK11 safety relays or the 3RK3 Modular Safety System;  
see Catalog IC 14, Chapter 13, "Safety Systems".  
Certificate:



# Push Button Units and Indicator Lights

## 3SU1 22 mm, Round, Plastic, Black — Complete Units









• Revised •  
08/31/15

### Selector switches

#### Selection and ordering data

Operating principle	Supply voltage	Number of NO contacts	Number of NC contacts	DT	Screw terminals 	PU (UNIT, SET, M)	PS*
	V				Order No.		

#### Selector switches

 3SU1100-2BF60-1BA0	<b>Short black actuator, 2 switch positions, can be illuminated, white</b>						
	Latching, 90°	--	1	0	▶	<b>3SU1100-2BF60-1BA0</b>	1 1 unit
		--	1	1	▶	<b>3SU1100-2BF60-1MA0</b>	1 1 unit
		--	1	0	B	<b>3SU1103-2BF60-1BA0</b>	1 1 unit
 3SU1100-2BM60-1NA0	<b>Short black actuator, 3 switch positions, can be illuminated, white</b>						
	Momentary contact, 2x45°, reset from left + right	--	2	0	▶	<b>3SU1100-2BM60-1NA0</b>	1 1 unit
							
	Latching, 2x45°	--	2	0	▶	<b>3SU1100-2BL60-1NA0</b>	1 1 unit
 3SU1100-2BL60-3NA0	<b>Short black actuator, 2 switch positions, can be illuminated, white</b>						
	Latching, 90°	--	1	0	B	<b>3SU1100-2BF60-3BA0</b>	1 1 unit
		--	1	1	B	<b>3SU1100-2BF60-3MA0</b>	1 1 unit
	<b>Short black actuator, 3 switch positions, can be illuminated, white</b>						
Momentary contact, 2x45°, reset from left + right	--	2	0	B	<b>3SU1100-2BM60-3NA0</b>	1 1 unit	
							
Latching, 2x45°		2	0	B	<b>3SU1100-2BL60-3NA0</b>	1 1 unit	
							



• Revised •  
08/31/15

# Push Button Units and Indicator Lights

## 3SU1 22 mm, Round, Plastic, Black — Complete Units







### Key-operated switches

1  
2  
3  
4  
5  
6  
7  
8  
9  
10

#### Selection and ordering data

Operating principle	Switch position for key removal	Number of NO contacts	Number of NC contacts	DT	Screw terminals 	PU (UNIT, SET, M)	PS*
					Order No.		

#### Key-operated switches with 2 keys

 3SU1100-4BF11-1BA0	<b>With Ronis lock, SB30, 2 switch positions (O+I)</b> Latching, 90° (10:30/1:30 o'clock) 	O+I	1	0	▶	<b>3SU1100-4BF11-1BA0</b>	1	1 unit
	<b>With Ronis lock, SB30, 3 switch positions (I+O+II)</b> Latching, 2x45° (10:30/1:30 o'clock) 	O+I+II	2	0	▶		<b>3SU1100-4BL11-1NA0</b>	1
 3SU1100-4BF11-3BA0	<b>With Ronis lock, SB30, 2 switch positions (O+I)</b> Latching, 90° (10:30/1:30 o'clock) 	O+I	1	0	B	<b>Spring-type terminals</b>  <b>3SU1100-4BF11-3BA0</b>	1	1 unit



# Push Button Units and Indicator Lights

## 3SU1 22 mm, Round, Plastic, Black — Complete Units

• Revised •  
08/31/15

### Indicator lights

#### Selection and ordering data

Operational voltage At AC, rated value	Operational voltage At DC, rated value	Color Of actuating element	Color Of light source	DT	Screw terminals	PU (UNIT, SET, M)	PS*	
								Order No.
<b>Indicator lights</b>								
<b>With smooth lens and integrated LED</b>								
	24	24	Red	Red	▶	<b>3SU1102-6AA20-1AA0</b>	1	1 unit
			Yellow	Yellow	▶	<b>3SU1102-6AA30-1AA0</b>	1	1 unit
			Green	Green	▶	<b>3SU1102-6AA40-1AA0</b>	1	1 unit
			Blue	Blue	▶	<b>3SU1102-6AA50-1AA0</b>	1	1 unit
			White	White	▶	<b>3SU1102-6AA60-1AA0</b>	1	1 unit
			Clear	White	A	<b>3SU1102-6AA70-1AA0</b>	1	1 unit
	110	--	Amber	Amber	▶	<b>3SU1103-6AA00-1AA0</b>	1	1 unit
			Red	Red	A	<b>3SU1103-6AA20-1AA0</b>	1	1 unit
			Yellow	Yellow	A	<b>3SU1103-6AA30-1AA0</b>	1	1 unit
			Green	Green	A	<b>3SU1103-6AA40-1AA0</b>	1	1 unit
			Blue	Blue	B	<b>3SU1103-6AA50-1AA0</b>	1	1 unit
			White	White	A	<b>3SU1103-6AA60-1AA0</b>	1	1 unit
			Clear	White	B	<b>3SU1103-6AA70-1AA0</b>	1	1 unit
	230	--	Amber	Amber	▶	<b>3SU1106-6AA00-1AA0</b>	1	1 unit
			Red	Red	A	<b>3SU1106-6AA20-1AA0</b>	1	1 unit
			Yellow	Yellow	A	<b>3SU1106-6AA30-1AA0</b>	1	1 unit
			Green	Green	A	<b>3SU1106-6AA40-1AA0</b>	1	1 unit
			Blue	Blue	B	<b>3SU1106-6AA50-1AA0</b>	1	1 unit
			White	White	A	<b>3SU1106-6AA60-1AA0</b>	1	1 unit
			Clear	White	B	<b>3SU1106-6AA70-1AA0</b>	1	1 unit
<b>Spring-type terminals</b>								
	24	24	Red	Red	B	<b>3SU1102-6AA20-3AA0</b>	1	1 unit
			Yellow	Yellow	B	<b>3SU1102-6AA30-3AA0</b>	1	1 unit
			Green	Green	B	<b>3SU1102-6AA40-3AA0</b>	1	1 unit
			Blue	Blue	B	<b>3SU1102-6AA50-3AA0</b>	1	1 unit
			White	White	B	<b>3SU1102-6AA60-3AA0</b>	1	1 unit
			Clear	White	B	<b>3SU1102-6AA70-3AA0</b>	1	1 unit
	110	--	Red	Red	B	<b>3SU1103-6AA20-3AA0</b>	1	1 unit
			Yellow	Yellow	B	<b>3SU1103-6AA30-3AA0</b>	1	1 unit
			Green	Green	B	<b>3SU1103-6AA40-3AA0</b>	1	1 unit
			Blue	Blue	B	<b>3SU1103-6AA50-3AA0</b>	1	1 unit
			White	White	B	<b>3SU1103-6AA60-3AA0</b>	1	1 unit
			Clear	White	B	<b>3SU1103-6AA70-3AA0</b>	1	1 unit
	230	--	Red	Red	B	<b>3SU1106-6AA20-3AA0</b>	1	1 unit
			Yellow	Yellow	B	<b>3SU1106-6AA30-3AA0</b>	1	1 unit
			Green	Green	B	<b>3SU1106-6AA40-3AA0</b>	1	1 unit
			Blue	Blue	B	<b>3SU1106-6AA50-3AA0</b>	1	1 unit
			White	White	B	<b>3SU1106-6AA60-3AA0</b>	1	1 unit
			Clear	White	B	<b>3SU1106-6AA70-3AA0</b>	1	1 unit

• Revised •  
07/15/16

# Push Button Units and Indicator Lights

## 3SU1 22 mm, Round, Plastic, Black — Compact Units

Sensor switches / Potentiometers

1  
2  
3  
4  
5  
6  
7  
8  
9  
10

### Selection and ordering data

Operating principle	Number of NO contacts	Number of NC contacts	Color	DT	M12 connector, 4-pole	PU (UNIT, SET, M)	PS*
					Order No.		

#### Sensor switches



3SU1200-1SK10-2SA0

Whether integrated in the two-hand operation console or installed as a door opening contact, the capacitive sensor switch is suitable for many different applications in industrial environments.

The switch is actuated by simple contact with the hand or other part of the body (i.e. without the application of pressure). As a result, these switches are rugged, extremely durable and have the highest degree of protection IP66, IP67, IP69 (IP69K).

Without pressure	1	0	Black	A	<b>3SU1200-1SK10-2SA0</b>	1	1 unit
------------------	---	---	-------	---	---------------------------	---	--------

For optional accessories, see  
 "Protection for sensor switches" on page 13/122  
 "Connectors for sensor switches, angled socket with screw terminal connection" on page 13/128

### Selection and ordering data

Version of actuating element	Operating principle	Adjustable resistance	DT	Screw terminals	PU (UNIT, SET, M)	PS*
				Order No.		

#### Potentiometers



3SU1200-2PQ10-1AA0

Version of actuating element	Operating principle	Adjustable resistance	DT	Screw terminals	PU (UNIT, SET, M)	PS*
				Order No.		
		kΩ				
Rotary knob	Stepless	1	B	<b>3SU1200-2PQ10-1AA0</b>	1	1 unit
		2.2	B	<b>3SU1200-2PW10-1AA0</b>	1	1 unit
		4.7	B	<b>3SU1200-2PR10-1AA0</b>	1	1 unit
		10	B	<b>3SU1200-2PS10-1AA0</b>	1	1 unit
		47	B	<b>3SU1200-2PT10-1AA0</b>	1	1 unit
		100	B	<b>3SU1200-2PU10-1AA0</b>	1	1 unit
		470	B	<b>3SU1200-2PV10-1AA0</b>	1	1 unit

#### Labeling plates for potentiometers



3SU1900-0BG16-0RU0

Black/White (label/lettering)	None	40	--	DT	Labeling plates	PU (UNIT, SET, M)	PS*
					Order No.		
			SYMBOL: 0 ... 9	B	<b>3SU1900-0BG16-0AA0</b>	1	10 units
			SYMBOL: Power up	B	<b>3SU1900-0BG16-0RT0</b>	1	10 units
				B	<b>3SU1900-0BG16-0RU0</b>	1	10 units



# Push Button Units and Indicator Lights

## 3SU1 22 mm, Round, Plastic, Black — Compact Units

• Revised •  
07/15/16

### Pushbuttons with extended stroke

#### Selection and ordering data

Version	Color	DT	Order No.	PU (UNIT, SET, M)	PS*		
<b>Pushbuttons with extended stroke</b>							
 3SU1200-0EB20-0AA0	<b>Pushbuttons with flat button</b>		Red	B	<b>3SU1200-0EB20-0AA0</b>	1	1 unit
			Green	B	<b>3SU1200-0EB40-0AA0</b>	1	1 unit
 3SU1200-0FB10-0AA0	<b>Pushbuttons with raised button</b>		Black	A	<b>3SU1200-0FB10-0AA0</b>	1	1 unit
			Red	A	<b>3SU1200-0FB20-0AA0</b>	1	1 unit
 3SU1201-0EB70-0AA0	<b>Pushbuttons with flat transparent button for insertion of insert labels</b>		Red	A	<b>3SU1201-0EB20-0AA0</b>	1	1 unit
			Clear	A	<b>3SU1201-0EB70-0AA0</b>	1	1 unit

Version	Material	Color	DT	Order No.	PU (UNIT, SET, M)	PS*		
<b>Accessories</b>								
 3SU1900-0KG10-0AA0	<b>Extension plungers</b>		Plastic	Black	A	<b>3SU1900-0KG10-0AA0</b>	1	1 unit
			For compensation of the distance between the pushbutton and the unlatching button of an overload relay					

• Revised •  
08/31/15

# Push Button Units and Indicator Lights

## 3SU1 22 mm, Round, Plastic, Black — Actuating & Signaling Elements

Pushbuttons

1  
2  
3  
4  
5  
6  
7  
8  
9  
10

### Selection and ordering data



Version of actuating element Front ring version	Operating principle Unlatching method	Color, marking	DT	Order No.	PU (UNIT, SET, M)	PS*
<b>Pushbuttons</b>						
 3SU1000-0AB20-0AD0	<b>Pushbuttons with flat button</b> Standard	Momentary contact	Black ▶	3SU1000-0AB10-0AA0	1	1 unit
			Black, O B	3SU1000-0AB10-0AD0	1	1 unit
			Red ▶	3SU1000-0AB20-0AA0	1	1 unit
			Red, O A	3SU1000-0AB20-0AD0	1	1 unit
			Yellow ▶	3SU1000-0AB30-0AA0	1	1 unit
			Green ▶	3SU1000-0AB40-0AA0	1	1 unit
			Green, I A	3SU1000-0AB40-0AC0	1	1 unit
			Blue ▶	3SU1000-0AB50-0AA0	1	1 unit
			Blue, R ▶	3SU1000-0AB50-0AR0	1	1 unit
			White ▶	3SU1000-0AB60-0AA0	1	1 unit
			White, I B	3SU1000-0AB60-0AC0	1	1 unit
			Clear A	3SU1000-0AB70-0AA0	1	1 unit
			Gray B	3SU1000-0AB80-0AA0	1	1 unit
 3SU1000-0AA30-0AA0	Latching Push to unlatch	Black ▶	3SU1000-0AA10-0AA0	1	1 unit	
		Red ▶	3SU1000-0AA20-0AA0	1	1 unit	
		Yellow ▶	3SU1000-0AA30-0AA0	1	1 unit	
		Green ▶	3SU1000-0AA40-0AA0	1	1 unit	
		Blue ▶	3SU1000-0AA50-0AA0	1	1 unit	
		White ▶	3SU1000-0AA60-0AA0	1	1 unit	
 3SU1000-0BB30-0AA0	<b>Pushbuttons with raised button</b> Standard	Momentary contact	Black ▶	3SU1000-0BB10-0AA0	1	1 unit
			Red ▶	3SU1000-0BB20-0AA0	1	1 unit
			Yellow ▶	3SU1000-0BB30-0AA0	1	1 unit
			Green ▶	3SU1000-0BB40-0AA0	1	1 unit
			Blue ▶	3SU1000-0BB50-0AA0	1	1 unit
			White ▶	3SU1000-0BB60-0AA0	1	1 unit
 3SU1000-0CB40-0AA0	<b>Pushbuttons with flat button</b> Raised	Momentary contact	Black B	3SU1000-0CB10-0AA0	1	1 unit
			Red B	3SU1000-0CB20-0AA0	1	1 unit
			Yellow B	3SU1000-0CB30-0AA0	1	1 unit
			Green B	3SU1000-0CB40-0AA0	1	1 unit
			Blue B	3SU1000-0CB50-0AA0	1	1 unit
			White B	3SU1000-0CB60-0AA0	1	1 unit
 3SU1000-0DB50-0AA0	<b>Pushbuttons with flat button</b> Raised, castellated	Momentary contact	Black B	3SU1000-0DB10-0AA0	1	1 unit
			Red B	3SU1000-0DB20-0AA0	1	1 unit
			Yellow B	3SU1000-0DB30-0AA0	1	1 unit
			Green B	3SU1000-0DB40-0AA0	1	1 unit
			Blue B	3SU1000-0DB50-0AA0	1	1 unit
			White B	3SU1000-0DB60-0AA0	1	1 unit

# Push Button Units and Indicator Lights

## 3SU1 22 mm, Round, Plastic, Black — Actuating & Signaling Elements

• Revised •  
07/15/16

### Pushbuttons

Version of actuating element Front ring version	Operating principle Unlatching method	Color	DT	Order No.	PU (UNIT, SET, M)	PS*	
<b>Pushbuttons</b>							
 3SU1001-0AB40-0AA0	<b>Illuminated pushbuttons with flat button</b> Standard	Momentary contact	Amber	▶	<b>3SU1001-0AB00-0AA0</b>	1	1 unit
		Red	A	<b>3SU1001-0AB20-0AA0</b>	1	1 unit	
		Yellow	▶	<b>3SU1001-0AB30-0AA0</b>	1	1 unit	
		Green	▶	<b>3SU1001-0AB40-0AA0</b>	1	1 unit	
		Blue	▶	<b>3SU1001-0AB50-0AA0</b>	1	1 unit	
		White	▶	<b>3SU1001-0AB60-0AA0</b>	1	1 unit	
		Clear	▶	<b>3SU1001-0AB70-0AA0</b>	1	1 unit	
		Latching	Red	▶	<b>3SU1001-0AA20-0AA0</b>	1	1 unit
Push to unlatch	Yellow	B	<b>3SU1001-0AA30-0AA0</b>	1	1 unit		
	Green	▶	<b>3SU1001-0AA40-0AA0</b>	1	1 unit		
	Blue	▶	<b>3SU1001-0AA50-0AA0</b>	1	1 unit		
	White	▶	<b>3SU1001-0AA60-0AA0</b>	1	1 unit		
	Clear	B	<b>3SU1001-0AA70-0AA0</b>	1	1 unit		
 3SU1001-0BB70-0AA0	<b>Illuminated pushbuttons with raised button</b> Standard	Momentary contact	Red	▶	<b>3SU1001-0BB20-0AA0</b>	1	1 unit
		Yellow	▶	<b>3SU1001-0BB30-0AA0</b>	1	1 unit	
		Green	▶	<b>3SU1001-0BB40-0AA0</b>	1	1 unit	
		Blue	▶	<b>3SU1001-0BB50-0AA0</b>	1	1 unit	
		Clear	▶	<b>3SU1001-0BB70-0AA0</b>	1	1 unit	
 3SU1001-0DB50-0AA0	<b>Illuminated pushbuttons with flat button</b> Raised, castellated	Momentary contact	Blue	B	<b>3SU1001-0DB50-0AA0</b>	1	1 unit
 3SU1000-0HC10-0AA0	<b>Stop pushbuttons</b> Standard	momentary contact, latching by pressing in and turning to the right, rotate-to-unlatch to the left	Black	B	<b>3SU1000-0HC10-0AA0</b>	1	1 unit
			Red	B	<b>3SU1000-0HC20-0AA0</b>	1	1 unit

• Revised •  
07/15/16





# Push Button Units and Indicator Lights

## 3SU1 22 mm, Round, Plastic, Black — Actuating & Signaling Elements

Twin pushbuttons

1  
2  
3  
4  
5  
6  
7  
8  
9  
10

### Selection and ordering data

Version of actuating element	Operating principle	Color	Marking	DT	Order No.	PU (UNIT, SET, M)	PS*				
<b>Twin pushbuttons</b>											
 <p>3SU1000-3AB66-0AL0</p>	Twin pushbuttons flat, flat	Momentary contact	Green / Red	-- I / O	B ▶	3SU1000-3AB42-0AA0 3SU1000-3AB42-0AK0	1 1	1 unit 1 unit			
			White / Black	-- I / O	B ▶	3SU1000-3AB61-0AA0 3SU1000-3AB61-0AK0	1 1	1 unit 1 unit			
			White / White	-- - / + Arrows, hor. Arrows, vert.	B B B B	3SU1000-3AB66-0AA0 3SU1000-3AB66-0AL0 3SU1000-3AB66-0AM0 3SU1000-3AB66-0AN0	1 1 1 1	1 unit 1 unit 1 unit 1 unit			
			Black / Black	-- ○ ○ 5264 / 5265 (IEC 60417)	B B	3SU1000-3AB11-0AA0 3SU1000-3AB11-0AQ0	1 1	1 unit 1 unit			
			 <p>3SU1000-3BB42-0AK0</p>	Twin pushbuttons flat, raised	Momentary contact	Green / Red	-- I / O	B ▶	3SU1000-3BB42-0AA0 3SU1000-3BB42-0AK0	1 1	1 unit 1 unit
						White / Black	-- I / O	B ▶	3SU1000-3BB61-0AA0 3SU1000-3BB61-0AK0	1 1	1 unit 1 unit
						 <p>3SU1001-3AB42-0AN0</p>	Twin pushbuttons flat, flat, illuminated	Momentary contact	Green / Red	-- I / O Arrows, vert.	B ▶ B
			White / Black	-- I / O	B ▶				3SU1001-3AB61-0AA0 3SU1001-3AB61-0AK0	1 1	1 unit 1 unit
			White / White	-- - / + Arrows, vert. Symbols "Circular saw blade" / "Tilt tipper"	B B B B B				3SU1001-3AB66-0AA0 3SU1001-3AB66-0AL0 3SU1001-3AB66-0AN0 3SU1001-3AB66-0AP0	1 1 1 1	1 unit 1 unit 1 unit 1 unit
			 <p>3SU1001-3BB61-0AK0</p>	Twin pushbuttons flat, raised, illuminated	Momentary contact				Green / Red	-- I / O	B ▶
White / Black	-- I / O	B ▶				3SU1001-3BB61-0AA0 3SU1001-3BB61-0AK0	1 1	1 unit 1 unit			







# Push Button Units and Indicator Lights

## 3SU1 22 mm, Round, Plastic, Black — Actuating & Signaling Elements

• Revised •  
08/31/15

### Mushroom pushbuttons

#### Selection and ordering data

Version of actuating element	Operating principle Unlatching method	Color, marking	DT	Order No.	PU (UNIT, SET, M)	PS*
<b>Mushroom pushbuttons</b>						
 3SU1000-1AD20-0AA0	<b>Mushroom pushbuttons</b> 30 mm diameter, 2 positions	Momentary contact	Black ▶	3SU1000-1AD10-0AA0	1	1 unit
			Red ▶	3SU1000-1AD20-0AA0	1	1 unit
			Yellow ▶	3SU1000-1AD30-0AA0	1	1 unit
			Green B	3SU1000-1AD40-0AA0	1	1 unit
	Latching, Pull to unlatch	Black ▶	3SU1000-1AA10-0AA0	1	1 unit	
		Red ▶	3SU1000-1AA20-0AA0	1	1 unit	
Yellow B	3SU1000-1AA30-0AA0	1	1 unit			
 3SU1000-1BD40-0AA0	<b>Mushroom pushbuttons</b> 40 mm diameter, 2 positions	Momentary contact	Black ▶	3SU1000-1BD10-0AA0	1	1 unit
			Red ▶	3SU1000-1BD20-0AA0	1	1 unit
			Yellow B	3SU1000-1BD30-0AA0	1	1 unit
			Green ▶	3SU1000-1BD40-0AA0	1	1 unit
	Latching, Pull to unlatch	Black A	3SU1000-1BA10-0AA0	1	1 unit	
		Red ▶	3SU1000-1BA20-0AA0	1	1 unit	
Red, O B	3SU1000-1BA20-0AD0	1	1 unit			
Yellow B	3SU1000-1BA30-0AA0	1	1 unit			
Green B	3SU1000-1BA40-0AA0	1	1 unit			
 3SU1000-1CD10-0AA0	<b>Mushroom pushbuttons</b> 60 mm diameter, 2 positions	Momentary contact	Black ▶	3SU1000-1CD10-0AA0	1	1 unit
			Red ▶	3SU1000-1CD20-0AA0	1	1 unit
			Yellow B	3SU1000-1CD30-0AA0	1	1 unit
			Green B	3SU1000-1CD40-0AA0	1	1 unit
	Latching, Pull to unlatch	Black B	3SU1000-1CA10-0AA0	1	1 unit	
		Red B	3SU1000-1CA20-0AA0	1	1 unit	
 3SU1001-1AD30-0AA0	<b>Mushroom pushbuttons</b> 30 mm diameter, 2 positions, illuminated	Momentary contact	Red B	3SU1001-1AD20-0AA0	1	1 unit
			Yellow ▶	3SU1001-1AD30-0AA0	1	1 unit
			Green B	3SU1001-1AD40-0AA0	1	1 unit
			Blue B	3SU1001-1AD50-0AA0	1	1 unit
			White B	3SU1001-1AD60-0AA0	1	1 unit
			Clear B	3SU1001-1AD70-0AA0	1	1 unit
	Latching Pull to unlatch	Red ▶	3SU1001-1AA20-0AA0	1	1 unit	
		Yellow B	3SU1001-1AA30-0AA0	1	1 unit	
		Green B	3SU1001-1AA40-0AA0	1	1 unit	
		Blue B	3SU1001-1AA50-0AA0	1	1 unit	
		Clear B	3SU1001-1AA70-0AA0	1	1 unit	
		 3SU1001-1BA50-0AA0	<b>Mushroom pushbuttons</b> 40 mm diameter, 2 positions, illuminated	Momentary contact	Yellow B	3SU1001-1BD30-0AA0
	Green B			3SU1001-1BD40-0AA0	1	1 unit
	White B			3SU1001-1BD60-0AA0	1	1 unit
	Clear B			3SU1001-1BD70-0AA0	1	1 unit
Latching, Pull to unlatch	Red ▶		3SU1001-1BA20-0AA0	1	1 unit	
	Yellow B		3SU1001-1BA30-0AA0	1	1 unit	
Green B	3SU1001-1BA40-0AA0	1	1 unit			
Blue B	3SU1001-1BA50-0AA0	1	1 unit			
Clear B	3SU1001-1BA70-0AA0	1	1 unit			
 3SU1000-1HB10-0AA0	<b>Mushroom pushbuttons</b> with raised mushroom, 40 mm diameter, 2 positions	With positive latching, tamper-proof	Black A	3SU1000-1HB10-0AA0	1	1 unit
		Rotate to unlatch	Blue B	3SU1000-1HB50-0AA0	1	1 unit



• Revised •  
08/31/15





# Push Button Units and Indicator Lights

## 3SU1 22 mm, Round, Plastic, Black — Actuating & Signaling Elements

### EMERGENCY STOP mushroom pushbuttons

1  
2  
3  
4  
5  
6  
7  
8  
9  
10

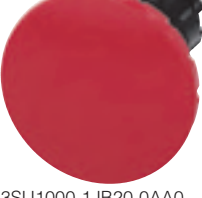
#### Selection and ordering data

Version of actuating element	Outer diameter of mushroom mm	Make of lock	Color	DT	Order No.	PU (UNIT, SET, M)	PS*
<b>EMERGENCY STOP mushroom pushbuttons</b>							
<b>With pull-to-unlatch mechanism</b>							
 3SU1000-1HA20-0AA0	Tamper-proof, 2 positions	40	--	Red	▶	<b>3SU1000-1HA20-0AA0</b>	1 1 unit
	<hr/>						
<b>With rotate-to-unlatch mechanism</b>							
 3SU1000-1GB20-0AA0	Tamper-proof, 2 positions	33.8	--	Red	▶	<b>3SU1000-1GB20-0AA0</b>	1 1 unit
	<hr/>						
 3SU1000-1HB20-0AA0		40	--	Red	▶	<b>3SU1000-1HB20-0AA0</b>	1 1 unit
	<hr/>						
 3SU1000-1JB20-0AA0		60	--	Red	A	<b>3SU1000-1JB20-0AA0</b>	1 1 unit
	<hr/>						
<b>With rotate-to-unlatch mechanism, can be illuminated</b>							
 3SU1001-1HB20-0AA0	Tamper-proof, 2 positions	33.8	--	Red	B	<b>3SU1001-1GB20-0AA0</b>	1 1 unit
		40	--	Red	A	<b>3SU1001-1HB20-0AA0</b>	1 1 unit
		60	--	Red	B	<b>3SU1001-1JB20-0AA0</b>	1 1 unit

# Push Button Units and Indicator Lights

## 3SU1 22 mm, Round, Plastic, Black — Actuating & Signaling Elements

• Revised •  
07/15/16

### EMERGENCY STOP mushroom pushbuttons

Version of actuating element	Outer diameter of mushroom mm	Make of lock	Color	Number of keys	DT	Order No.	PU (UNIT, SET, M)	PS*	
<b>EMERGENCY STOP mushroom pushbuttons, in accordance with ISO 13850 and IEC 60947-5-5</b>									
<b>With key-operated release</b>									
Tamper-proof, 2 positions	40	RONIS SB30	Red	2	▶	<b>3SU1000-1HF20-0AA0</b>	1	1 unit	
		RONIS 455	Red	2	B		<b>3SU1000-1HG20-0AA0</b>	1	1 unit
		BKS S1	Red	2	A	<b>3SU1000-1HK20-0AA0</b>	1	1 unit	
		O.M.R. 73037	Red	2	A	<b>3SU1000-1HQ20-0AA0</b>	1	1 unit	
		CES SSG10	Red	2	▶	<b>3SU1000-1HR20-0AA0</b>	1	1 unit	
		CES SSP9	Red	2	A		<b>3SU1000-1HS20-0AA0</b>	1	1 unit
		CES SMS1	Red	2	B		<b>3SU1000-1HT20-0AA0</b>	1	1 unit



3SU1000-1HF20-0AA0



3SU1000-1HK20-0AA0



3SU1000-1HQ20-0AA0



3SU1000-1HR20-0AA0

### Selection and ordering data

Number of switching positions	Number of command points	Color of actuating element	Operating principle of the actuating element	DT	Order No.	PU (UNIT, SET, M)	PS*
<b>Toggle switches</b>							
2	1	Black	Latching Momentary contact Reset from above	B	<b>3SU1000-3EA10-0AA0</b>	1	1 unit
				B		<b>3SU1000-3EC10-0AA0</b>	1



3SU1000-3EA10-0AA0

• Revised •  
07/15/16

# Push Button Units and Indicator Lights

## 3SU1 22 mm, Round, Plastic, Black — Actuating & Signaling Elements

Selector switches

1  
2  
3  
4  
5  
6  
7  
8  
9  
10

### Selection and ordering data

Version of actuator	Operating principle	Color	DT	Article No.	Price per PU	PU (UNIT, SET, M)	PS*
---------------------	---------------------	-------	----	-------------	--------------	-------------------	-----

#### Selector switches

#### 2 switch positions, can be illuminated



3SU1002-2BC40-0AA0



3SU1002-2BF30-0AA0



3SU1002-2CF20-0AA0



3SU1002-2AF20-0AA0

Selector, short black actuator	Momentary contact, 45° (10:30/12 o'clock), reset from center to left 	Black	B	<b>3SU1002-2BC10-0AA0</b>		1	1 unit
		Red	B	<b>3SU1002-2BC20-0AA0</b>		1	1 unit
		Yellow	B	<b>3SU1002-2BC30-0AA0</b>		1	1 unit
		Green	B	<b>3SU1002-2BC40-0AA0</b>		1	1 unit
		Blue	B	<b>3SU1002-2BC50-0AA0</b>		1	1 unit
		White	▶	<b>3SU1002-2BC60-0AA0</b>		1	1 unit
Selector, long black actuator	Latching, 90° (10:30/1:30 o'clock) 	Black	▶	<b>3SU1002-2BF10-0AA0</b>		1	1 unit
		Red	▶	<b>3SU1002-2BF20-0AA0</b>		1	1 unit
		Yellow	B	<b>3SU1002-2BF30-0AA0</b>		1	1 unit
		Green	A	<b>3SU1002-2BF40-0AA0</b>		1	1 unit
		Blue	A	<b>3SU1002-2BF50-0AA0</b>		1	1 unit
		White	▶	<b>3SU1002-2BF60-0AA0</b>		1	1 unit
Selector, long black actuator	Latching, 90° (10:30/1:30 o'clock) 	Black	B	<b>3SU1002-2CF10-0AA0</b>		1	1 unit
		Red	B	<b>3SU1002-2CF20-0AA0</b>		1	1 unit
		White	B	<b>3SU1002-2CF60-0AA0</b>		1	1 unit
Rotary knob	Latching, 90° (10:30/1:30 o'clock) 	Red	B	<b>3SU1002-2AF20-0AA0</b>		1	1 unit
		White	A	<b>3SU1002-2AF60-0AA0</b>		1	1 unit

# Push Button Units and Indicator Lights

## 3SU1 22 mm, Round, Plastic, Black — Actuating & Signaling Elements

• Revised •  
07/15/16

### Selector switches

Version of actuator	Operating principle	Color	DT	Order No.	PU (UNIT, SET, M)	PS*
<b>Selector switches</b>						
<b>3 switch positions, can be illuminated</b>						
 3SU1002-2BM20-0AA0	Selector, short black actuator Momentary contact, 2x45° (10:30/12/1:30 o'clock), reset from right + left 	Black	B	<b>3SU1002-2BM10-0AA0</b>	1	1 unit
		Red	B	<b>3SU1002-2BM20-0AA0</b>	1	1 unit
		Yellow	B	<b>3SU1002-2BM30-0AA0</b>	1	1 unit
		Green	A	<b>3SU1002-2BM40-0AA0</b>	1	1 unit
		Blue	B	<b>3SU1002-2BM50-0AA0</b>	1	1 unit
		White	▶	<b>3SU1002-2BM60-0AA0</b>	1	1 unit
 3SU1002-2BL60-0AA0	Latching, 2x45° (10:30/12/1:30 o'clock) 	Black	▶	<b>3SU1002-2BL10-0AA0</b>	1	1 unit
		Red	▶	<b>3SU1002-2BL20-0AA0</b>	1	1 unit
		Yellow	B	<b>3SU1002-2BL30-0AA0</b>	1	1 unit
		Green	A	<b>3SU1002-2BL40-0AA0</b>	1	1 unit
		Blue	A	<b>3SU1002-2BL50-0AA0</b>	1	1 unit
		White	▶	<b>3SU1002-2BL60-0AA0</b>	1	1 unit
 3SU1002-2BP50-0AA0	Momentary contact/latching, 2x45° (10:30/12/1:30 o'clock), reset from left, latching to right 	Black	B	<b>3SU1002-2BP10-0AA0</b>	1	1 unit
		Red	B	<b>3SU1002-2BP20-0AA0</b>	1	1 unit
		Yellow	B	<b>3SU1002-2BP30-0AA0</b>	1	1 unit
		Green	B	<b>3SU1002-2BP40-0AA0</b>	1	1 unit
		Blue	B	<b>3SU1002-2BP50-0AA0</b>	1	1 unit
		White	▶	<b>3SU1002-2BP60-0AA0</b>	1	1 unit
 3SU1002-2BN30-0AA0	Latching/momentary contact, 2x45° (10:30/12/1:30 o'clock), reset from right, latching to left 	Black	B	<b>3SU1002-2BN10-0AA0</b>	1	1 unit
		Red	B	<b>3SU1002-2BN20-0AA0</b>	1	1 unit
		Yellow	B	<b>3SU1002-2BN30-0AA0</b>	1	1 unit
		Green	▶	<b>3SU1002-2BN40-0AA0</b>	1	1 unit
		Blue	B	<b>3SU1002-2BN50-0AA0</b>	1	1 unit
		White	▶	<b>3SU1002-2BN60-0AA0</b>	1	1 unit
<b>4 switch positions</b>						
 3SU1000-2AS60-0AA0	Rotary knob Latching, 4x90° (0-position: 3/6/9/12 o'clock) 	White	B	<b>3SU1000-2AS60-0AA0</b>	1	1 unit

• Revised •  
07/15/16

# Push Button Units and Indicator Lights

## 3SU1 22 mm, Round, Plastic, Black — Actuating & Signaling Elements

### Key-operated switches

1  
2  
3  
4  
5  
6  
7  
8  
9  
10

#### Selection and ordering data

Operating principle	Make of lock	Switch position for key removal	Number of keys	DT	Order No.	PU (UNIT, SET, M)	PS*
---------------------	--------------	---------------------------------	----------------	----	-----------	-------------------	-----

#### Key-operated switches

##### 2 switch positions (O+I)

Momentary contact, 45° (10:30/12 o'clock), reset from center to left



3SU1000-4JC01-0AA0

RONIS, SB30	O	2	▶		<b>3SU1000-4BC01-0AA0</b>	1	1 unit
RONIS, 455	O	2	B		<b>3SU1000-4CC01-0AA0</b>	1	1 unit
O.M.R. 73037, red	O	2	B		<b>3SU1000-4FC01-0AA0</b>	1	1 unit
O.M.R. 73038, light blue	O	2	B		<b>3SU1000-4GC01-0AA0</b>	1	1 unit
O.M.R. 73034, black	O	2	B		<b>3SU1000-4HC01-0AA0</b>	1	1 unit
O.M.R. 73033, yellow	O	2	B		<b>3SU1000-4JC01-0AA0</b>	1	1 unit
CES, SSG10	O	2	▶		<b>3SU1000-5BC01-0AA0</b>	1	1 unit
CES, LSG1		2	B		<b>3SU1000-5HC01-0AA0</b>	1	1 unit
BKS, S1	O	2	A		<b>3SU1000-5PC01-0AA0</b>	1	1 unit
IKON, 360012K1	O	2	A		<b>3SU1000-5XC01-0AA0</b>	1	1 unit

Latching, 90° (10:30/1:30 o'clock)



3SU1000-4BF11-0AA0

RONIS, SB30	O	2	A		<b>3SU1000-4BF01-0AA0</b>	1	1 unit
	O+I	2	▶		<b>3SU1000-4BF11-0AA0</b>	1	1 unit
	I	2	A		<b>3SU1000-4BF21-0AA0</b>	1	1 unit
RONIS, 455	O	2	B		<b>3SU1000-4CF01-0AA0</b>	1	1 unit
	O+I	2	B		<b>3SU1000-4CF11-0AA0</b>	1	1 unit
RONIS, 421	O+I	2	B		<b>3SU1000-4DF11-0AA0</b>	1	1 unit



3SU1000-4GF11-0AA0

O.M.R. 73037, red	O	2	B		<b>3SU1000-4FF01-0AA0</b>	1	1 unit
	O+I	2	B		<b>3SU1000-4FF11-0AA0</b>	1	1 unit
O.M.R. 73038, light blue	O	2	▶		<b>3SU1000-4GF01-0AA0</b>	1	1 unit
	O+I	2	B		<b>3SU1000-4GF11-0AA0</b>	1	1 unit
O.M.R. 73034, black	O	2	B		<b>3SU1000-4HF01-0AA0</b>	1	1 unit
	O+I	2	B		<b>3SU1000-4HF11-0AA0</b>	1	1 unit
	I	2	B		<b>3SU1000-4HF21-0AA0</b>	1	1 unit
O.M.R. 73033, yellow	O	2	B		<b>3SU1000-4JF01-0AA0</b>	1	1 unit
	O+I	2	B		<b>3SU1000-4JF11-0AA0</b>	1	1 unit



3SU1000-5BF11-0AA0

CES, SSG10	O	2	▶		<b>3SU1000-5BF01-0AA0</b>	1	1 unit
	O+I	2	▶		<b>3SU1000-5BF11-0AA0</b>	1	1 unit
	I	2	▶		<b>3SU1000-5BF21-0AA0</b>	1	1 unit
CES, LSG1	O	2	A		<b>3SU1000-5HF01-0AA0</b>	1	1 unit
	O+I	2	A		<b>3SU1000-5HF11-0AA0</b>	1	1 unit



3SU1000-5PF11-0AA0

BKS, S1	O	2	A		<b>3SU1000-5PF01-0AA0</b>	1	1 unit
	O+I	2	A		<b>3SU1000-5PF11-0AA0</b>	1	1 unit
	I	2	B		<b>3SU1000-5PF21-0AA0</b>	1	1 unit







IKON, 360012K1	O	2	A		<b>3SU1000-5XF01-0AA0</b>	1	1 unit
	O+I	2	A		<b>3SU1000-5XF11-0AA0</b>	1	1 unit

# Push Button Units and Indicator Lights

## 3SU1 22 mm, Round, Plastic, Black — Actuating & Signaling Elements

• Revised •  
07/15/16

### Key-operated switches

Operating principle	Make of lock	Switch position for key removal	DT	Order No.	PU (UNIT, SET, M)	PS*	
<b>Key-operated switches</b>							
<b>3 switch positions (I+O+II)</b>							
Momentary contact, 2x45°(10:30/12/1:30 o'clock), reset from left + right 	RONIS, SB30	O	A	<b>3SU1000-4BM01-0AA0</b>	1	1 unit	
	O.M.R. 73037, red	O	B	<b>3SU1000-4FM01-0AA0</b>	1	1 unit	
	O.M.R. 73034, black	O	▶	<b>3SU1000-4HM01-0AA0</b>	1	1 unit	
	CES, SSG10	O	A	<b>3SU1000-5BM01-0AA0</b>	1	1 unit	
	BKS, S1	O	B	<b>3SU1000-5PM01-0AA0</b>	1	1 unit	
	IKON, 360012K1	O	B	<b>3SU1000-5XM01-0AA0</b>	1	1 unit	
	Latching, 2x45° (10:30/12/1:30 o'clock) 	RONIS, SB30	O	B	<b>3SU1000-4BL01-0AA0</b>	1	1 unit
			O+I+II	▶	<b>3SU1000-4BL11-0AA0</b>	1	1 unit
			I	▶	<b>3SU1000-4BL21-0AA0</b>	1	1 unit
			II (right)	B	<b>3SU1000-4BL31-0AA0</b>	1	1 unit
		I+II (left, right)	B	<b>3SU1000-4BL41-0AA0</b>	1	1 unit	
		O+I (center, left)	B	<b>3SU1000-4BL51-0AA0</b>	1	1 unit	
RONIS, 455		O	B	<b>3SU1000-4CL01-0AA0</b>	1	1 unit	
		O+I+II	B	<b>3SU1000-4CL11-0AA0</b>	1	1 unit	
		O	B	<b>3SU1000-4FL01-0AA0</b>	1	1 unit	
		O+I (center, left)	▶	<b>3SU1000-4FL51-0AA0</b>	1	1 unit	
	O.M.R. 73037, red	O	B	<b>3SU1000-4FL01-0AA0</b>	1	1 unit	
	O.M.R. 73038, light blue	O	B	<b>3SU1000-4GL01-0AA0</b>	1	1 unit	
	O.M.R. 73034, black	O+I+II	B	<b>3SU1000-4GL11-0AA0</b>	1	1 unit	
	O.M.R. 73034, black	O	B	<b>3SU1000-4HL01-0AA0</b>	1	1 unit	
	O.M.R. 73033, yellow	O+I+II	B	<b>3SU1000-4HL11-0AA0</b>	1	1 unit	
		O+I+II	B	<b>3SU1000-4JL11-0AA0</b>	1	1 unit	
		CES, SSG10	O	▶	<b>3SU1000-5BL01-0AA0</b>	1	1 unit
			O+I+II	▶	<b>3SU1000-5BL11-0AA0</b>	1	1 unit
			I	▶	<b>3SU1000-5BL21-0AA0</b>	1	1 unit
			II (right)	▶	<b>3SU1000-5BL31-0AA0</b>	1	1 unit
		I+II (left, right)	▶	<b>3SU1000-5BL41-0AA0</b>	1	1 unit	
		O+I (center, left)	B	<b>3SU1000-5BL51-0AA0</b>	1	1 unit	
	BKS, S1	O	B	<b>3SU1000-5PL01-0AA0</b>	1	1 unit	
		O+I+II	B	<b>3SU1000-5PL11-0AA0</b>	1	1 unit	
		I	B	<b>3SU1000-5PL21-0AA0</b>	1	1 unit	
		II (right)	B	<b>3SU1000-5PL31-0AA0</b>	1	1 unit	
		I+II (left, right)	B	<b>3SU1000-5PL41-0AA0</b>	1	1 unit	
		O	B	<b>3SU1000-5XL01-0AA0</b>	1	1 unit	
	IKON, 360012K1	O	B	<b>3SU1000-5XL01-0AA0</b>	1	1 unit	
		O+I+II	B	<b>3SU1000-5XL11-0AA0</b>	1	1 unit	

• Revised •  
08/31/15

# Push Button Units and Indicator Lights

## 3SU1 22 mm, Round, Plastic, Black — Actuating & Signaling Elements

### Key-operated switches / ID key-operated switches

1  
2  
3  
4  
5  
6  
7  
8  
9  
10

Operating principle	Make of lock	Switch position for key removal	DT	Order No.	PU (UNIT, SET, M)	PS*
---------------------	--------------	---------------------------------	----	-----------	-------------------	-----

#### Key-operated switches

##### 3 switch positions (I+O+II)



Momentary contact/  
latching, 2x45°  
(10:30/12/  
1:30 o'clock),  
reset from left,  
latching to the right



RONIS, SB30

O  
II (right)  
O+II (center, right)

B  
B  
B

**3SU1000-4BP01-0AA0**  
**3SU1000-4BP31-0AA0**  
**3SU1000-4BP61-0AA0**

1  
1  
1

1 unit  
1 unit  
1 unit



CES, SSG10

O  
II (right)  
O+II (center, right)

B  
B  
B

**3SU1000-5BP01-0AA0**  
**3SU1000-5BP31-0AA0**  
**3SU1000-5BP61-0AA0**

1  
1  
1

1 unit  
1 unit  
1 unit

BKS, S1

O

B

**3SU1000-5PP01-0AA0**

1

1 unit

Latching/momentary  
contact, 2x45°  
(10:30/12/  
1:30 o'clock),  
reset from right, latch-  
ing to the left



O.M.R. 73038,  
light blue  
O.M.R. 73034,  
black

O  
I

B  
B

**3SU1000-4GN01-0AA0**  
**3SU1000-4HN21-0AA0**

1  
1

1 unit  
1 unit



CES, SSG10

O  
I  
O+I (center, left)

B  
B  
B

**3SU1000-5BN01-0AA0**  
**3SU1000-5BN21-0AA0**  
**3SU1000-5BN51-0AA0**

1  
1  
1

1 unit  
1 unit  
1 unit

BKS, S1

I  
O+I (center, left)

B  
B

**3SU1000-5PN21-0AA0**  
**3SU1000-5PN51-0AA0**

1  
1

1 unit  
1 unit

IKON, 360012K1

O+I (center, left)

B

**3SU1000-5XN51-0AA0**

1

1 unit

#### Selection and ordering data

Operating angle	Operating principle	Switch position for key removal	Color	DT	Order No.	PU (UNIT, SET, M)	PS*
-----------------	---------------------	---------------------------------	-------	----	-----------	-------------------	-----

#### ID key-operated switches

##### 4 switch positions (O+I+II+III)



45°

Latching

O+I+II+III

Black

A

**3SU1000-4WS10-0AA0**

1

1 unit

For available keys, [see page 10/143](#)

For electronic modules for ID key-operated switches,  
[see page 10/109](#)

# Push Button Units and Indicator Lights

## 3SU1 22 mm, Round, Plastic, Black — Actuating & Signaling Elements

• Revised •  
07/15/16

### Indicator lights

#### Selection and ordering data

Version of actuating element	Color	DT	Order No.	PU (UNIT, SET, M)	PS*
 <p><b>Indicator lights</b> with smooth lens</p>	Amber	▶	3SU1001-6AA00-0AA0	1	1 unit
	Red	▶	3SU1001-6AA20-0AA0	1	1 unit
	Yellow	▶	3SU1001-6AA30-0AA0	1	1 unit
	Green	▶	3SU1001-6AA40-0AA0	1	1 unit
	Blue	▶	3SU1001-6AA50-0AA0	1	1 unit
	White	▶	3SU1001-6AA60-0AA0	1	1 unit
	Clear	▶	3SU1001-6AA70-0AA0	1	1 unit

3SU1001-6AA40-0AA0



• Revised •  
08/31/15

# Push Button Units and Indicator Lights

## 3SU1 22 mm, Plastic with Metal Front Ring, Matte — Complete Units

Pushbuttons

1  
2  
3  
4  
5  
6  
7  
8  
9  
10

### Selection and ordering data

Supply voltage for light source		Color	Number of NO contacts	Number of NC contacts	DT	Screw terminals	⊕	PU (UNIT, SET, M)	PS*
At AC	At DC								
V	V					Order No.			

#### Pushbuttons

##### Pushbuttons with flat button, momentary contact



3SU1130-0AB10-1BA0

--	--	Black	1	0	▶	3SU1130-0AB10-1BA0		1	1 unit
			0	1	▶	3SU1130-0AB10-1CA0		1	1 unit
		Red	1	0	B	3SU1130-0AB20-1BA0		1	1 unit
			0	1	▶	3SU1130-0AB20-1CA0		1	1 unit
		Yellow	1	0	▶	3SU1130-0AB30-1BA0		1	1 unit
		Green	1	0	▶	3SU1130-0AB40-1BA0		1	1 unit
		Blue	1	0	▶	3SU1130-0AB50-1BA0		1	1 unit
		White	1	0	▶	3SU1130-0AB60-1BA0		1	1 unit

##### Pushbuttons with raised button, momentary contact



3SU1130-0BB20-1CA0

--	--	Red	0	1	▶	3SU1130-0BB20-1CA0		1	1 unit
----	----	-----	---	---	---	--------------------	--	---	--------

##### Illuminated pushbuttons with flat button, momentary contact with integrated LED



3SU1132-0AB40-1BA0

24	24	Red	1	0	B	3SU1132-0AB20-1BA0		1	1 unit
			0	1	▶	3SU1132-0AB20-1CA0		1	1 unit
		Yellow	1	0	▶	3SU1132-0AB30-1BA0		1	1 unit
		Green	1	0	▶	3SU1132-0AB40-1BA0		1	1 unit
		Blue	1	0	▶	3SU1132-0AB50-1BA0		1	1 unit
		White	1	0	▶	3SU1132-0AB60-1BA0		1	1 unit
		Clear	1	0	▶	3SU1132-0AB70-1BA0		1	1 unit
110	--	Red	0	1	B	3SU1133-0AB20-1CA0		1	1 unit
		Yellow	1	0	B	3SU1133-0AB30-1BA0		1	1 unit
		Green	1	0	B	3SU1133-0AB40-1BA0		1	1 unit
		Blue	1	0	B	3SU1133-0AB50-1BA0		1	1 unit
		White	1	0	B	3SU1133-0AB60-1BA0		1	1 unit
		Clear	1	0	B	3SU1133-0AB70-1BA0		1	1 unit

# Push Button Units and Indicator Lights

## 3SU1 22 mm, Plastic with Metal Front Ring, Matte — Complete Units

• Revised •  
08/31/15

### Actuators and Indicators

Supply voltage for light source		Color	Number of NO contacts	Number of NC contacts	DT	Screw terminals 	PU (UNIT, SET, M)	PS*	
At AC	At DC								
V	V					Order No.			
<b>Pushbuttons</b>									
<b>Illuminated pushbuttons with flat button, momentary contact with integrated LED</b>									
	230	--	Red	0	1	B	3SU1136-0AB20-1CA0	1	1 unit
			Yellow	1	0	B	3SU1136-0AB30-1BA0	1	1 unit
			Green	1	0	B	3SU1136-0AB40-1BA0	1	1 unit
			Blue	1	0	B	3SU1136-0AB50-1BA0	1	1 unit
			White	1	0	B	3SU1136-0AB60-1BA0	1	1 unit
			Clear	1	0	B	3SU1136-0AB70-1BA0	1	1 unit
<b>Spring-type terminals </b>									
<b>Pushbuttons with flat button, momentary contact</b>									
	--	--	Black	1	0	B	3SU1130-0AB10-3BA0	1	1 unit
			Red	0	1	B	3SU1130-0AB20-3CA0	1	1 unit
			Green	1	0	B	3SU1130-0AB40-3BA0	1	1 unit
<b>Illuminated pushbuttons with flat button, momentary contact with integrated LED</b>									
	24	24	Red	0	1	B	3SU1132-0AB20-3CA0	1	1 unit
			Yellow	1	0	B	3SU1132-0AB30-3BA0	1	1 unit
			Green	1	0	B	3SU1132-0AB40-3BA0	1	1 unit
			Blue	1	0	▶	3SU1132-0AB50-3BA0	1	1 unit
			White	1	0	B	3SU1132-0AB60-3BA0	1	1 unit
			Clear	1	0	B	3SU1132-0AB70-3BA0	1	1 unit

• Revised •  
07/15/16

# Push Button Units and Indicator Lights

## 3SU1 22 mm, Plastic with Metal Front Ring, Matte — Complete Units

### Mushroom pushbuttons / EMERGENCY STOP mushroom pushbuttons

1  
2  
3  
4  
5  
6  
7  
8  
9  
10

#### Selection and ordering data

Unlatching method	Number of NO contacts	Number of NC contacts	DT	Screw terminals 	PU (UNIT, SET, M)	PS*
Order No.						

#### Mushroom pushbuttons

##### With red mushroom, diameter 40 mm, latching



3SU1130-1BA20-1CA0

Pull to unlatch	0	1	▶	3SU1130-1BA20-1CA0	1	1 unit
-----------------	---	---	---	--------------------	---	--------

#### Selection and ordering data

Unlatching method	Number of NO contacts	Number of NC contacts	Marking	DT	Screw terminals 	PU (UNIT, SET, M)	PS*
Order No.							

#### EMERGENCY STOP mushroom pushbuttons, tamper-proof, in accordance with ISO 13850 and IEC 60947-5-5

##### With red mushroom, diameter 40 mm, with positive latching



3SU1100-1HA20-1CH0

Pull to unlatch	0	1	NOT-HALT	B	3SU1100-1HA20-1CH0	1	1 unit
-----------------	---	---	----------	---	--------------------	---	--------



3SU1100-1HB20-1CG0

Rotate to unlatch	0	1	None	B	3SU1100-1HB20-1CF0	1	1 unit
	0	1	EMERGENCY STOP	B	3SU1100-1HB20-1CG0	1	1 unit
	1	1	EMERGENCY STOP	B	3SU1100-1HB20-1FG0	1	1 unit



3SU1100-1HB20-3CH0

					Spring-type terminals 		
Rotate to unlatch	0	1	NOT-HALT	B	3SU1100-1HB20-3CH0	1	1 unit













# Push Button Units and Indicator Lights

## 3SU1 22 mm, Plastic with Metal Front Ring, Matte — Complete Units

• Revised •  
08/31/15

Coordinate switches, complete

### Selection and ordering data

Operating principle	Color	Number of NO contacts	Number of NC contacts	DT	Screw terminals	PU (UNIT, SET, M)	PS*
					Order No.		
<b>Selector switches</b>							
<b>Short black actuator, 2 switch positions, can be illuminated</b>							
 Latching, 90° 	White	1	0	▶	<b>3SU1130-2BF60-1BA0</b> <b>3SU1130-2BF60-1MA0</b>	1	1 unit
		1	1	▶		1	1 unit
<b>Short black actuator, 3 switch positions, can be illuminated</b>							
 Momentary contact, 2x45° 		2	0	▶	<b>3SU1130-2BM60-1NA0</b>	1	1 unit
 Latching, 2x45° 		2	0	▶	<b>3SU1130-2BL60-1NA0</b>	1	1 unit
<b>Short black actuator, 2 switch positions, can be illuminated</b>							
 Latching, 90° 	White	1	0	B	<b>3SU1130-2BF60-3BA0</b> <b>3SU1130-2BF60-3MA0</b>	1	1 unit
		1	1	B		1	1 unit
<b>Short black actuator, 3 switch positions, can be illuminated</b>							
 Momentary contact, 2x45° 	White	2	0	B	<b>3SU1130-2BM60-3NA0</b>	1	1 unit
 Latching, 2x45° 		2	0	B	<b>3SU1130-2BL60-3NA0</b>	1	1 unit

• Revised •  
08/31/15

# Push Button Units and Indicator Lights

## 3SU1 22 mm, Plastic with Metal Front Ring, Matte — Complete Units

Coordinate switches, complete

1  
2  
3  
4  
5  
6  
7  
8  
9  
10

### Selection and ordering data

Operating principle	Switch position for key removal	Number of NO contacts	Number of NC contacts	DT	Screw terminals 	PU (UNIT, SET, M)	PS*
					Order No.		

#### Key-operated switches with 2 keys



3SU1130-4BF11-1BA0

#### With Ronis lock, SB30, 2 switch positions (O+I)

Latching, 90°  
(10:30/1:30 o'clock)



O+I	1	0	▶	<b>3SU1130-4BF11-1BA0</b>	1	1 unit
-----	---	---	---	---------------------------	---	--------

#### With Ronis lock, SB30, 3 switch positions (I+O+II)

Latching, 2x45°  
(10:30/1:30 o'clock)



O+I	2	0	B	<b>3SU1130-4BL11-1NA0</b>	1	1 unit
-----	---	---	---	---------------------------	---	--------



3SU1130-4BL11-1NA0

#### With Ronis lock, SB30, 2 switch positions (O+I)

Latching, 90°  
(10:30/1:30 o'clock)



					Spring-type terminals 		
O+I	1	0	B	<b>3SU1130-4BF11-3BA0</b>	1	1 unit	

# Push Button Units and Indicator Lights

## 3SU1 22 mm, Plastic with Metal Front Ring, Matte — Complete Units

• Revised •  
08/31/15

### Indicator Lights Complete Units

#### Selection and ordering data

Indicator lights	Operational voltage		Color		DT	Screw terminals	PU (UNIT, SET, M)	PS*
	at AC, rated value	at DC, rated value	of actuating element	of light source				
V								
<b>With smooth lens and integrated LED</b>								
 3SU1102-6AA30-1AA0	24	24	Red	Red	A	3SU1102-6AA20-1AA0	1	1 unit
			Yellow	Yellow	A	3SU1102-6AA30-1AA0	1	1 unit
			Green	Green	A	3SU1102-6AA40-1AA0	1	1 unit
			Blue	Blue	A	3SU1102-6AA50-1AA0	1	1 unit
			White	White	A	3SU1102-6AA60-1AA0	1	1 unit
			Clear	White	A	3SU1102-6AA70-1AA0	1	1 unit
 3SU1103-6AA00-1AA0	110	--	Amber	Amber	B	3SU1103-6AA00-1AA0	1	1 unit
			Red	Red	A	3SU1103-6AA20-1AA0	1	1 unit
			Yellow	Yellow	A	3SU1103-6AA30-1AA0	1	1 unit
			Green	Green	A	3SU1103-6AA40-1AA0	1	1 unit
			Blue	Blue	B	3SU1103-6AA50-1AA0	1	1 unit
			White	White	A	3SU1103-6AA60-1AA0	1	1 unit
Clear	White	B	3SU1103-6AA70-1AA0	1	1 unit			
 3SU1106-6AA50-1AA0	230	--	Amber	Amber	B	3SU1106-6AA00-1AA0	1	1 unit
			Red	Red	A	3SU1106-6AA20-1AA0	1	1 unit
			Yellow	Yellow	A	3SU1106-6AA30-1AA0	1	1 unit
			Green	Green	A	3SU1106-6AA40-1AA0	1	1 unit
			Blue	Blue	B	3SU1106-6AA50-1AA0	1	1 unit
			White	White	A	3SU1106-6AA60-1AA0	1	1 unit
Clear	White	B	3SU1106-6AA70-1AA0	1	1 unit			
<b>Spring-type terminals</b>								
 3SU1102-6AA20-3AA0	24	24	Red	Red	B	3SU1102-6AA20-3AA0	1	1 unit
			Yellow	Yellow	B	3SU1102-6AA30-3AA0	1	1 unit
			Green	Green	B	3SU1102-6AA40-3AA0	1	1 unit
			Blue	Blue	B	3SU1102-6AA50-3AA0	1	1 unit
			White	White	B	3SU1102-6AA60-3AA0	1	1 unit
			Clear	White	B	3SU1102-6AA70-3AA0	1	1 unit
 3SU1102-6AA40-3AA0	110	--	Red	Red	B	3SU1103-6AA20-3AA0	1	1 unit
			Yellow	Yellow	B	3SU1103-6AA30-3AA0	1	1 unit
			Green	Green	B	3SU1103-6AA40-3AA0	1	1 unit
			Blue	Blue	B	3SU1103-6AA50-3AA0	1	1 unit
			White	White	B	3SU1103-6AA60-3AA0	1	1 unit
			Clear	White	B	3SU1103-6AA70-3AA0	1	1 unit
 3SU1106-6AA60-3AA0	230	--	Red	Red	B	3SU1106-6AA20-3AA0	1	1 unit
			Yellow	Yellow	B	3SU1106-6AA30-3AA0	1	1 unit
			Green	Green	B	3SU1106-6AA40-3AA0	1	1 unit
			Blue	Blue	B	3SU1106-6AA50-3AA0	1	1 unit
			White	White	B	3SU1106-6AA60-3AA0	1	1 unit
			Clear	White	B	3SU1106-6AA70-3AA0	1	1 unit

• Revised •  
07/15/16

# Push Button Units and Indicator Lights

## 3SU1 22 mm, Plastic with Metal Front Ring, Matte — Compact Units

### Sensor switches / potentiometers

1  
2  
3  
4  
5  
6  
7  
8  
9  
10

#### Selection and ordering data

Operating principle	Number of NO contacts	Number of NC contacts	Color	DT	M12 connector, 4-pole	PU (UNIT, SET, M)	PS*
					Order No.		

#### Sensor switches



Whether integrated in the two-hand operation console or installed as a door opening contact, the capacitive sensor switch is suitable for many different applications in industrial environments.

The switch is actuated by simple contact with the hand or other part of the body (i.e. without the application of pressure). As a result, these switches are rugged, extremely durable and have the highest degree of protection IP66, IP67, IP69 (IP69K).

Without pressure	1	0	Black	A	<b>3SU1200-1SK10-2SA0</b>	1	1 unit
------------------	---	---	-------	---	---------------------------	---	--------

3SU1200-1SK10-2SA0

For optional accessories, see  
"Protection for sensor switches" on page 13/122.  
"Connectors for sensor switches, angled socket with screw terminal connection" on page 13/128.

#### Selection and ordering data

Version of actuating element	Operating principle	Adjustable resistance	DT	Screw terminals	PU (UNIT, SET, M)	PS*
				⊕		
				Order No.		

#### Potentiometers



Rotary knob	Stepless	1	B	<b>3SU1200-2PQ10-1AA0</b>	1	1 unit
		4.7	B	<b>3SU1200-2PR10-1AA0</b>	1	1 unit
		10	B	<b>3SU1200-2PS10-1AA0</b>	1	1 unit
		47	B	<b>3SU1200-2PT10-1AA0</b>	1	1 unit
		100	B	<b>3SU1200-2PU10-1AA0</b>	1	1 unit
		470	B	<b>3SU1200-2PV10-1AA0</b>	1	1 unit

3SU1200-2PQ10-1AA0

#### Labeling plates for potentiometers



Black/White (label/lettering)	None	40	--	▶	<b>3SU1900-0BG16-0AA0</b>	1	10 units
			SYMBOL: 0 ... 9	B	<b>3SU1900-0BG16-0RT0</b>	1	10 units
			SYMBOL: Power up	B	<b>3SU1900-0BG16-0RU0</b>	1	10 units

3SU1900-0BG16-0RU0



# Push Button Units and Indicator Lights

## 3SU1 22 mm, Plastic with Metal Front Ring, Matte — Compact Units

• Revised •  
07/15/16

Sensor switches /  
Pushbuttons with extended stroke

### Selection and ordering data

Version	Color	DT	Order No.	PU (UNIT, SET, M)	PS*
<b>Pushbuttons with extended stroke</b>					
 3SU1230-0EB40-0AA0	<b>Pushbuttons with flat button</b>	Red	B	<b>3SU1230-0EB20-0AA0</b>	1 1 unit
		Green	B	<b>3SU1230-0EB40-0AA0</b>	1 1 unit
 3SU1230-0FB10-0AA0	<b>Pushbuttons with raised button</b>	Black	B	<b>3SU1230-0FB10-0AA0</b>	1 1 unit
 3SU1231-0EB20-0AA0	<b>Pushbuttons with flat transparent button for insertion of insert labels</b>	Red	B	<b>3SU1231-0EB20-0AA0</b>	1 1 unit
		Clear	B	<b>3SU1231-0EB70-0AA0</b>	1 1 unit

Version	Material	Color	DT	Order No.	PU (UNIT, SET, M)	PS*
<b>Accessories</b>						
 3SU1900-0KG10-0AA0	<b>Extension plungers</b>	Plastic	Gray	A	<b>3SU1900-0KG10-0AA0</b>	1 1 unit
		For compensation of the distance between the pushbutton and the unlatching button of an overload relay				



• Revised •  
08/31/15

# Push Button Units and Indicator Lights

## Plastic with Metal Front Ring, Matte — Actuating and Signaling Elements

Pushbuttons

1  
2  
3  
4  
5  
6  
7  
8  
9  
10

### Selection and ordering data



Version of actuating element Front ring version	Operating principle Unlatching method	Color, marking	DT	Order No.	PU (UNIT, SET, M)	PS*	
<b>Pushbuttons</b>							
 3SU1030-0AB50-0AR0	<b>Pushbuttons with flat button</b> Standard	Momentary contact	Black ▶	3SU1030-0AB10-0AA0	1	1 unit	
			Black, O	B	3SU1030-0AB10-0AD0	1	1 unit
			Red ▶	B	3SU1030-0AB20-0AA0	1	1 unit
			Red, O	B	3SU1030-0AB20-0AD0	1	1 unit
			Red, AUTO	B	3SU1030-0AB20-0AQ0	1	1 unit
			Yellow ▶	B	3SU1030-0AB30-0AA0	1	1 unit
			Green ▶	B	3SU1030-0AB40-0AA0	1	1 unit
			Green, I	B	3SU1030-0AB40-0AC0	1	1 unit
			Blue ▶	B	3SU1030-0AB50-0AA0	1	1 unit
			Blue, R	B	3SU1030-0AB50-0AR0	1	1 unit
			White ▶	B	3SU1030-0AB60-0AA0	1	1 unit
			White, I	B	3SU1030-0AB60-0AC0	1	1 unit
			Clear ▶	B	3SU1030-0AB70-0AA0	1	1 unit
			Gray	B	3SU1030-0AB80-0AA0	1	1 unit
		 3SU1030-0AA40-0AA0	<b>Pushbuttons with flat button</b> Standard	Latching	Black ▶	3SU1030-0AA10-0AA0	1
Push to unlatch	Red			B	3SU1030-0AA20-0AA0	1	1 unit
	Yellow			B	3SU1030-0AA30-0AA0	1	1 unit
	Green			B	3SU1030-0AA40-0AA0	1	1 unit
	Blue ▶			B	3SU1030-0AA50-0AA0	1	1 unit
	White			B	3SU1030-0AA60-0AA0	1	1 unit
 3SU1030-0BB20-0AA0	<b>Pushbuttons with raised button</b> Standard	Momentary contact	Black ▶	3SU1030-0BB10-0AA0	1	1 unit	
			Red ▶	B	3SU1030-0BB20-0AA0	1	1 unit
			Yellow	B	3SU1030-0BB30-0AA0	1	1 unit
			Green	B	3SU1030-0BB40-0AA0	1	1 unit
			Blue	B	3SU1030-0BB50-0AA0	1	1 unit
			White	B	3SU1030-0BB60-0AA0	1	1 unit
 3SU1030-0CB30-0AA0	<b>Pushbuttons with flat button</b> Raised	Momentary contact	Black	B	3SU1030-0CB10-0AA0	1	1 unit
			Red	B	3SU1030-0CB20-0AA0	1	1 unit
			Yellow	B	3SU1030-0CB30-0AA0	1	1 unit
			Green	B	3SU1030-0CB40-0AA0	1	1 unit
			Blue	B	3SU1030-0CB50-0AA0	1	1 unit
			White	B	3SU1030-0CB60-0AA0	1	1 unit

# Push Button Units and Indicator Lights

## 3SU1 22 mm, Plastic with Metal Front Ring, Matte — Actuating and Signaling

• Revised •  
08/31/15

### Pushbuttons

Version of actuating element Front ring version	Operating principle Unlatching method	Color	DT	Order No.	PU (UNIT, SET, M)	PS*	
<b>Pushbuttons</b>							
 3SU1031-0AB20-0AA0	<b>Illuminated pushbuttons with fiat button</b> Standard Momentary contact	Amber	▶	3SU1031-0AB00-0AA0	1	1 unit	
		Red	▶	3SU1031-0AB20-0AA0	1	1 unit	
		Yellow	▶	3SU1031-0AB30-0AA0	1	1 unit	
		Green	▶	3SU1031-0AB40-0AA0	1	1 unit	
		Blue	▶	3SU1031-0AB50-0AA0	1	1 unit	
		White	▶	3SU1031-0AB60-0AA0	1	1 unit	
		Clear	▶	3SU1031-0AB70-0AA0	1	1 unit	
	 3SU1031-0AA50-0AA0	Latching Push to unlatch	Red	B	3SU1031-0AA20-0AA0	1	1 unit
			Yellow	B	3SU1031-0AA30-0AA0	1	1 unit
			Green	▶	3SU1031-0AA40-0AA0	1	1 unit
Blue			B	3SU1031-0AA50-0AA0	1	1 unit	
White			▶	3SU1031-0AA60-0AA0	1	1 unit	
Clear			B	3SU1031-0AA70-0AA0	1	1 unit	
 3SU1031-0BB40-0AA0	<b>Illuminated pushbuttons with raised button</b> Standard Momentary contact	Red	B	3SU1031-0BB20-0AA0	1	1 unit	
		Yellow	B	3SU1031-0BB30-0AA0	1	1 unit	
		Green	▶	3SU1031-0BB40-0AA0	1	1 unit	
		Blue	▶	3SU1031-0BB50-0AA0	1	1 unit	
		Clear	▶	3SU1031-0BB70-0AA0	1	1 unit	



• Revised •  
07/15/16

# Push Button Units and Indicator Lights Plastic with Metal Front Ring, Matte — Actuating and Signaling Elements

## Twin pushbuttons

1  
2  
3  
4  
5  
6  
7  
8  
9  
10

### Selection and ordering data

Version of actuating element	Operating principle	Color	Marking	DT	Order No.	PU (UNIT, SET, M)	PS*	
<b>Twin pushbuttons</b>								
 <p>3SU1030-3AB66-0AN0</p>	Twin pushbuttons flat, flat	Momentary contact	Green / Red	--	B	3SU1030-3AB42-0AA0	1	1 unit
				I / O	▶	3SU1030-3AB42-0AK0	1	1 unit
			White / Black	--	B	3SU1030-3AB61-0AA0	1	1 unit
				I / O	B	3SU1030-3AB61-0AK0	1	1 unit
			White / White	--	B	3SU1030-3AB66-0AA0	1	1 unit
				Arrows, vert.	B	3SU1030-3AB66-0AN0	1	1 unit
			Black / Black	--	B	3SU1030-3AB11-0AA0	1	1 unit
				○	B	3SU1030-3AB11-0AQ0	1	1 unit
5264 / 5265 (IEC 60417)								
 <p>3SU1030-3BB42-0AK0</p>	Twin pushbuttons flat, raised	Momentary contact	Green / Red	--	B	3SU1030-3BB42-0AA0	1	1 unit
				I / O	▶	3SU1030-3BB42-0AK0	1	1 unit
 <p>3SU1031-3AB42-0AK0</p>	Twin pushbuttons flat, flat, illuminated	Momentary contact	Green / Red	--	B	3SU1031-3AB42-0AA0	1	1 unit
				I / O	▶	3SU1031-3AB42-0AK0	1	1 unit
				Arrows, vert.	B	3SU1031-3AB42-0AN0	1	1 unit
			White / Black	--	B	3SU1031-3AB61-0AA0	1	1 unit
				I / O	▶	3SU1031-3AB61-0AK0	1	1 unit
			White / White	--	B	3SU1031-3AB66-0AA0	1	1 unit
	Arrows, vert.	B	3SU1031-3AB66-0AN0	1	1 unit			
 <p>3SU1031-3BB61-0AA0</p>	Twin pushbuttons flat, raised, illuminated	Momentary contact	Green / Red	--	B	3SU1031-3BB42-0AA0	1	1 unit
				I / O	▶	3SU1031-3BB42-0AK0	1	1 unit
			White / Black	--	B	3SU1031-3BB61-0AA0	1	1 unit
				I / O	B	3SU1031-3BB61-0AK0	1	1 unit





# Push Button Units and Indicator Lights

## 3SU1 22 mm, Plastic with Metal Front Ring, Matte — Actuating and Signaling

• Revised •  
08/31/15

### Mushroom pushbuttons

#### Selection and ordering data

Version of actuating element	Operating principle Unlatching method	Color	DT	Order No.	PU (UNIT, SET, M)	PS*
<b>Mushroom pushbuttons</b>						
 3SU1030-1AD20-0AA0	<b>Mushroom pushbuttons</b> 30 mm diameter, 2 positions	Momentary contact	Black ▶	<b>3SU1030-1AD10-0AA0</b>	1	1 unit
			Red ▶	<b>3SU1030-1AD20-0AA0</b>	1	1 unit
			Yellow B	<b>3SU1030-1AD30-0AA0</b>	1	1 unit
			Green ▶	<b>3SU1030-1AD40-0AA0</b>	1	1 unit
		Latching Pull to unlatch	Black ▶	<b>3SU1030-1AA10-0AA0</b>	1	1 unit
		Red ▶	<b>3SU1030-1AA20-0AA0</b>	1	1 unit	
 3SU1030-1BD40-0AA0	<b>Mushroom pushbuttons</b> 40 mm diameter, 2 positions	Momentary contact	Black ▶	<b>3SU1030-1BD10-0AA0</b>	1	1 unit
			Red ▶	<b>3SU1030-1BD20-0AA0</b>	1	1 unit
			Yellow ▶	<b>3SU1030-1BD30-0AA0</b>	1	1 unit
			Green ▶	<b>3SU1030-1BD40-0AA0</b>	1	1 unit
		Latching Pull to unlatch	Black ▶	<b>3SU1030-1BA10-0AA0</b>	1	1 unit
		Red ▶	<b>3SU1030-1BA20-0AA0</b>	1	1 unit	
		Red, O B	<b>3SU1030-1BA20-0AD0</b>	1	1 unit	
 3SU1031-1AD30-0AA0	<b>Mushroom pushbuttons</b> 30 mm diameter, 2 positions, illuminated	Momentary contact	Yellow B	<b>3SU1031-1AD30-0AA0</b>	1	1 unit
			Green ▶	<b>3SU1031-1AD40-0AA0</b>	1	1 unit
			White ▶	<b>3SU1031-1AD60-0AA0</b>	1	1 unit
			Clear B	<b>3SU1031-1AD70-0AA0</b>	1	1 unit
		Latching Pull to unlatch	Red ▶	<b>3SU1031-1AA20-0AA0</b>	1	1 unit
		Yellow B	<b>3SU1031-1AA30-0AA0</b>	1	1 unit	
 3SU1031-1BD60-0AA0	<b>Mushroom pushbuttons</b> 40 mm diameter, 2 positions, illuminated	Momentary contact	Yellow ▶	<b>3SU1031-1BD30-0AA0</b>	1	1 unit
			Green ▶	<b>3SU1031-1BD40-0AA0</b>	1	1 unit
			White B	<b>3SU1031-1BD60-0AA0</b>	1	1 unit
			Clear B	<b>3SU1031-1BD70-0AA0</b>	1	1 unit
		Latching Pull to unlatch	Red ▶	<b>3SU1031-1BA20-0AA0</b>	1	1 unit
		Yellow B	<b>3SU1031-1BA30-0AA0</b>	1	1 unit	
 3SU1000-1HB50-0AA0	<b>Mushroom pushbuttons</b> with raised mushroom, 40 mm diameter, 2 positions	With positive latching, tamper-proof	Black A	<b>3SU1000-1HB10-0AA0</b>	1	1 unit
		Rotate to unlatch	Blue B	<b>3SU1000-1HB50-0AA0</b>	1	1 unit





• Revised •  
08/31/15

# Push Button Units and Indicator Lights Plastic with Metal Front Ring, Matte — Actuating and Signaling Elements

## EMERGENCY STOP Mushroom pushbuttons

1  
2  
3  
4  
5  
6  
7  
8  
9  
10

### Selection and ordering data





Version of actuating element	Outer diameter of mushroom mm	Make of lock	Color	DT	Order No.	PU (UNIT, SET, M)	PS*
<b>EMERGENCY STOP mushroom pushbuttons</b>							
<b>With pull-to-unlatch mechanism</b>							
 3SU1000-1HA20-0AA0	Tamper-proof, 2 positions 40	--	Red	A	<b>3SU1000-1HA20-0AA0</b>	1	1 unit
<b>With rotate-to-unlatch mechanism</b>							
 3SU1000-1GB20-0AA0	Tamper-proof, 2 positions 33.8	--	Red	A	<b>3SU1000-1GB20-0AA0</b>	1	1 unit
 3SU1000-1HB20-0AA0	40	--	Red	A	<b>3SU1000-1HB20-0AA0</b>	1	1 unit
 3SU1000-1JB20-0AA0	60	--	Red	▶	<b>3SU1000-1JB20-0AA0</b>	1	1 unit
<b>With rotate-to-unlatch mechanism, can be illuminated</b>							
 3SU1001-1GB20-0AA0	Tamper-proof, 2 positions 33.8	--	Red	B	<b>3SU1001-1GB20-0AA0</b>	1	1 unit
	40	--	Red	A	<b>3SU1001-1HB20-0AA0</b>	1	1 unit
	60	--	Red	B	<b>3SU1001-1JB20-0AA0</b>	1	1 unit

# Push Button Units and Indicator Lights

3SU1 22 mm, Plastic with Metal Front Ring, Matte — Actuating and Signaling

• Revised •  
07/15/16

## EMERGENCY STOP mushroom pushbuttons / toggle switches

Version of actuating element	Outer diameter of mushroom mm	Make of lock	Color	DT	Order No.	PU (UNIT, SET, M)	PS*
<b>EMERGENCY STOP mushroom pushbuttons</b>							
<b>With key-operated release</b>							
Tamper-proof, 2 positions	40	RONIS SB30	Red	A	<b>3SU1000-1HF20-0AA0</b> <b>3SU1000-1HG20-0AA0</b>	1	1 unit
		RONIS 455	Red	B			
							
3SU1000-1HF20-0AA0							
		BKS S1	Red	A	<b>3SU1000-1HK20-0AA0</b>	1	1 unit
							
3SU1000-1HK20-0AA0							
		O.M.R. 73037	Red	A	<b>3SU1000-1HQ20-0AA0</b>	1	1 unit
							
3SU1000-1HQ20-0AA0							
		CES SSG10	Red	A	<b>3SU1000-1HR20-0AA0</b> <b>3SU1000-1HS20-0AA0</b> <b>3SU1000-1HT20-0AA0</b>	1	1 unit
		CES SSP9	Red	A			
		CES SMS1	Red	B			
							
3SU1000-1HR20-0AA0							

### Selection and ordering data

Number of switching positions	Number of command points	Color of actuating element	Operating principle of actuating element	DT	Order No.	PU (UNIT, SET, M)	PS*
<b>Toggle switches</b>							
2	1	Black	Latching Momentary contact Reset from above	B	<b>3SU1030-3EA10-0AA0</b> <b>3SU1030-3EC10-0AA0</b>	1	1 unit
				B			
							
3SU1030-3EA10-0AA0							

• Revised •  
07/15/16

# Push Button Units and Indicator Lights Plastic with Metal Front Ring, Matte — Actuating and Signaling Elements

## Selector switches

1  
2  
3  
4  
5  
6  
7  
8  
9  
10

### Selection and ordering data

Version of actuator	Operating principle	Color	DT	Order No.	PU (UNIT, SET, M)	PS*
<b>Selector switches</b>						
<b>2 switch positions, can be illuminated</b>						
 3SU1032-2BC40-0AA0	Selector, short black actuator Momentary contact, 45° (10:30/12 o'clock), reset from center to left 	Black	B	3SU1032-2BC10-0AA0	1	1 unit
		Red	B	3SU1032-2BC20-0AA0	1	1 unit
		Yellow	B	3SU1032-2BC30-0AA0	1	1 unit
		Green	B	3SU1032-2BC40-0AA0	1	1 unit
		Blue	B	3SU1032-2BC50-0AA0	1	1 unit
		White	▶	3SU1032-2BC60-0AA0	1	1 unit
 3SU1032-2BF30-0AA0	Latching, 90° (10:30/1:30 o'clock) 	Black	B	3SU1032-2BF10-0AA0	1	1 unit
		Red	▶	3SU1032-2BF20-0AA0	1	1 unit
		Yellow	B	3SU1032-2BF30-0AA0	1	1 unit
		Green	A	3SU1032-2BF40-0AA0	1	1 unit
		Blue	B	3SU1032-2BF50-0AA0	1	1 unit
		White	▶	3SU1032-2BF60-0AA0	1	1 unit
 3SU1032-2CF60-0AA0	Selector, long black actuator Latching, 90° (10:30/1:30 o'clock) 	Black	B	3SU1032-2CF10-0AA0	1	1 unit
		Red	B	3SU1032-2CF20-0AA0	1	1 unit
		White	B	3SU1032-2CF60-0AA0	1	1 unit
 3SU1032-2AF20-0AA0	Rotary knob Latching, 90° (10:30/1:30 o'clock) 	Red	B	3SU1032-2AF20-0AA0	1	1 unit
		White	B	3SU1032-2AF60-0AA0	1	1 unit

# Push Button Units and Indicator Lights

## 3SU1 22 mm, Plastic with Metal Front Ring, Matte — Actuating and Signal

• Revised •  
07/15/16

### Selector switches

Version of actuator	Operating principle	Color	DT	Order No.	PU (UNIT, SET, M)	PS*
<b>Selector switches</b>						
<b>3 switch positions, can be illuminated</b>						
 3SU1032-2BM60-0AA0	Selector, short black actuator Momentary contact, 2x45° (10:30/12/1:30 o'clock), reset from right + left 	Black	B	<b>3SU1032-2BM10-0AA0</b>	1	1 unit
		Red	B	<b>3SU1032-2BM20-0AA0</b>	1	1 unit
		Yellow	B	<b>3SU1032-2BM30-0AA0</b>	1	1 unit
		Green	B	<b>3SU1032-2BM40-0AA0</b>	1	1 unit
		Blue	B	<b>3SU1032-2BM50-0AA0</b>	1	1 unit
		White	▶	<b>3SU1032-2BM60-0AA0</b>	1	1 unit
 3SU1032-2BL20-0AA0	Latching, 2x45° (10:30/12/1:30 o'clock) 	Black	B	<b>3SU1032-2BL10-0AA0</b>	1	1 unit
		Red	B	<b>3SU1032-2BL20-0AA0</b>	1	1 unit
		Yellow	B	<b>3SU1032-2BL30-0AA0</b>	1	1 unit
		Green	A	<b>3SU1032-2BL40-0AA0</b>	1	1 unit
		Blue	B	<b>3SU1032-2BL50-0AA0</b>	1	1 unit
		White	▶	<b>3SU1032-2BL60-0AA0</b>	1	1 unit
 3SU1032-2BP40-0AA0	Momentary contact/latching, 2x45° (10:30/12/1:30 o'clock), reset from left, latching to right 	Black	B	<b>3SU1032-2BP10-0AA0</b>	1	1 unit
		Red	B	<b>3SU1032-2BP20-0AA0</b>	1	1 unit
		Yellow	B	<b>3SU1032-2BP30-0AA0</b>	1	1 unit
		Green	B	<b>3SU1032-2BP40-0AA0</b>	1	1 unit
		Blue	B	<b>3SU1032-2BP50-0AA0</b>	1	1 unit
		White	▶	<b>3SU1032-2BP60-0AA0</b>	1	1 unit
 3SU1032-2BN30-0AA0	Latching/momentary contact, 2x45° (10:30/12/1:30 o'clock), reset from right, latching to left 	Black	B	<b>3SU1032-2BN10-0AA0</b>	1	1 unit
		Red	B	<b>3SU1032-2BN20-0AA0</b>	1	1 unit
		Yellow	B	<b>3SU1032-2BN30-0AA0</b>	1	1 unit
		Green	B	<b>3SU1032-2BN40-0AA0</b>	1	1 unit
		Blue	B	<b>3SU1032-2BN50-0AA0</b>	1	1 unit
		White	▶	<b>3SU1032-2BN60-0AA0</b>	1	1 unit
<b>4 switch positions</b>						
 3SU1030-2AS60-0AA0	Rotary knob Latching, 4x90° (0-position: 3/6/9/12 o'clock) 	White	B	<b>3SU1030-2AS60-0AA0</b>	1	1 unit



• Revised •  
07/15/16

# Push Button Units and Indicator Lights

## Plastic with Metal Front Ring, Matte — Actuating and Signaling Elements

### Key-operated switches

1  
2  
3  
4  
5  
6  
7  
8  
9  
10

#### Selection and ordering data

Operating principle	Make of lock	Switch position for key removal	Number of keys	DT	Order No.	PU (UNIT, SET, M)	PS*
---------------------	--------------	---------------------------------	----------------	----	-----------	-------------------	-----

#### Key-operated switches

##### 2 switch positions (O+I)



Momentary contact, 45° (10:30/12 o'clock), reset from center to left



RONIS, SB30	O	2	▶	3SU1030-4BC01-0AA0	1	1 unit
RONIS, 455	O	2	B	3SU1030-4CC01-0AA0	1	1 unit
O.M.R. 73037, red	O	2	B	3SU1030-4FC01-0AA0	1	1 unit
O.M.R. 73038, light blue	O	2	B	3SU1030-4GC01-0AA0	1	1 unit
O.M.R. 73034, black	O	2	B	3SU1030-4HC01-0AA0	1	1 unit
O.M.R. 73033, yellow	O	2	B	3SU1030-4JC01-0AA0	1	1 unit
CES, SSG10	O	2	▶	3SU1030-5BC01-0AA0	1	1 unit
CES, LSG1	O	2	B	3SU1030-5HC01-0AA0	1	1 unit
BKS, S1	O	2	A	3SU1030-5PC01-0AA0	1	1 unit
IKON, 360012K1	O	2	B	3SU1030-5XC01-0AA0	1	1 unit



Latching, 90° (10:30/1:30 o'clock)



RONIS, SB30	O	2	▶	3SU1030-4BF01-0AA0	1	1 unit
	O+I	2	▶	3SU1030-4BF11-0AA0	1	1 unit
	I	2	B	3SU1030-4BF21-0AA0	1	1 unit
RONIS, 455	O	2	B	3SU1030-4CF01-0AA0	1	1 unit
	O+I	2	B	3SU1030-4CF11-0AA0	1	1 unit



O.M.R. 73037, red	O	2	B	3SU1030-4FF01-0AA0	1	1 unit
	O+I	2	B	3SU1030-4FF11-0AA0	1	1 unit
O.M.R. 73038, light blue	O	2	▶	3SU1030-4GF01-0AA0	1	1 unit
	O+I	2	B	3SU1030-4GF11-0AA0	1	1 unit
O.M.R. 73034, black	O	2	B	3SU1030-4HF01-0AA0	1	1 unit
	O+I	2	B	3SU1030-4HF11-0AA0	1	1 unit
	I	2	B	3SU1030-4HF21-0AA0	1	1 unit
O.M.R. 73033, yellow	O	2	B	3SU1030-4JF01-0AA0	1	1 unit
	O+I	2	B	3SU1030-4JF11-0AA0	1	1 unit



CES, SSG10	O	2	▶	3SU1030-5BF01-0AA0	1	1 unit
	O+I	2	▶	3SU1030-5BF11-0AA0	1	1 unit
	I	2	B	3SU1030-5BF21-0AA0	1	1 unit
CES, LSG1	O	2	B	3SU1030-5HF01-0AA0	1	1 unit
	O+I	2	B	3SU1030-5HF11-0AA0	1	1 unit



BKS, S1	O	2	B	3SU1030-5PF01-0AA0	1	1 unit
	O+I	2	B	3SU1030-5PF11-0AA0	1	1 unit
	I	2	B	3SU1030-5PF21-0AA0	1	1 unit







IKON, 360012K1	O	2	A	3SU1030-5XF01-0AA0	1	1 unit
	O+I	2	B	3SU1030-5XF11-0AA0	1	1 unit

# Push Button Units and Indicator Lights

## 3SU1 22 mm, Plastic with Metal Front Ring, Matte — Actuating and Signaling

• Revised •  
07/15/16

### Key-operated switches

Operating principle	Make of lock	Switch position for key removal	Number of keys	DT	Order No.	PU (UNIT, SET, M)	PS*
<b>Key-operated switches</b>							
<b>3 switch positions (I+O+II)</b>							
 3SU1030-4BM01-0AA0 Momentary contact, 2x45° (10:30/12/1:30 o'clock), reset from left + right 	RONIS, SB30	O	2	▶	<b>3SU1030-4BM01-0AA0</b>	1	1 unit
	O.M.R. 73037, red	O	2	B	<b>3SU1030-4FM01-0AA0</b>	1	1 unit
	O.M.R. 73034, black	O	2	B	<b>3SU1030-4HM01-0AA0</b>	1	1 unit
	CES, SSG10	O	2	A	<b>3SU1030-5BM01-0AA0</b>	1	1 unit
	BKS, S1	O	2	B	<b>3SU1030-5PM01-0AA0</b>	1	1 unit
	IKON, 360012K1	O	2	B	<b>3SU1030-5XM01-0AA0</b>	1	1 unit
 3SU1030-4JL11-0AA0 Latching, 2x45° (10:30/12/1:30 o'clock) 	RONIS, SB30	O	2	B	<b>3SU1030-4BL01-0AA0</b>	1	1 unit
	I+O+II	2	▶	<b>3SU1030-4BL11-0AA0</b>	1	1 unit	
	I	2	B	<b>3SU1030-4BL21-0AA0</b>	1	1 unit	
	II (right)	2	B	<b>3SU1030-4BL31-0AA0</b>	1	1 unit	
	I+II	2	B	<b>3SU1030-4BL41-0AA0</b>	1	1 unit	
	(left, right)						
	O+I (center, left)	2	B	<b>3SU1030-4BL51-0AA0</b>	1	1 unit	
	RONIS, 455	O	2	B	<b>3SU1030-4CL01-0AA0</b>	1	1 unit
	I+O+II	2	B	<b>3SU1030-4CL11-0AA0</b>	1	1 unit	
	O.M.R. 73037, red	O	2	B	<b>3SU1030-4FL01-0AA0</b>	1	1 unit
	O+I (center, left)	2	B	<b>3SU1030-4FL51-0AA0</b>	1	1 unit	
	 3SU1030-4JL11-0AA0 O.M.R. 73038, light blue I+O+II O.M.R. 73034, black O O.M.R. 73033, yellow I+O+II	O	2	▶	<b>3SU1030-4GL01-0AA0</b>	1	1 unit
I+O+II		2	B	<b>3SU1030-4GL11-0AA0</b>	1	1 unit	
O		2	B	<b>3SU1030-4HL01-0AA0</b>	1	1 unit	
I+O+II		2	B	<b>3SU1030-4HL11-0AA0</b>	1	1 unit	
I+O+II		2	B	<b>3SU1030-4JL11-0AA0</b>	1	1 unit	
 3SU1030-5BL41-0AA0 CES, SSG10 O I+O+II I II (right) I+II (left, right) O+I (center, left)	O	2	B	<b>3SU1030-5BL01-0AA0</b>	1	1 unit	
	I+O+II	2	A	<b>3SU1030-5BL11-0AA0</b>	1	1 unit	
	I	2	B	<b>3SU1030-5BL21-0AA0</b>	1	1 unit	
	II (right)	2	B	<b>3SU1030-5BL31-0AA0</b>	1	1 unit	
	I+II	2	B	<b>3SU1030-5BL41-0AA0</b>	1	1 unit	
	(left, right)						
	O+I (center, left)	2	B	<b>3SU1030-5BL51-0AA0</b>	1	1 unit	
 3SU1030-5PL01-0AA0 BKS, S1 O I+O+II I II (right) I+II (left, right)	O	2	B	<b>3SU1030-5PL01-0AA0</b>	1	1 unit	
	I+O+II	2	B	<b>3SU1030-5PL11-0AA0</b>	1	1 unit	
	I	2	B	<b>3SU1030-5PL21-0AA0</b>	1	1 unit	
	II (right)	2	B	<b>3SU1030-5PL31-0AA0</b>	1	1 unit	
	I+II	2	B	<b>3SU1030-5PL41-0AA0</b>	1	1 unit	
	(left, right)						
IKON, 360012K1 O I+O+II	O	2	B	<b>3SU1030-5XL01-0AA0</b>	1	1 unit	
	I+O+II	2	B	<b>3SU1030-5XL11-0AA0</b>	1	1 unit	

• Revised •  
08/31/15

# Push Button Units and Indicator Lights

## astic with Metal Front Ring, Matte — Actuating and Signaling Elements

### Key-operated switches / ID key-operated switches

1  
2  
3  
4  
5  
6  
7  
8  
9  
10

Operating principle	Make of lock	Switch position for key removal	Number of keys	DT	Order No.	PU (UNIT, SET, M)	PS*
---------------------	--------------	---------------------------------	----------------	----	-----------	-------------------	-----

#### Key-operated switches

##### 3 switch positions (I+O+II)



Momentary contact/latching, 2x45° (10:30/12/1:30 o'clock), reset from left, latching to the right



RONIS, SB30	O	2	B	<b>3SU1030-4BP01-0AA0</b>	1	1 unit
	II (right)	2	B	<b>3SU1030-4BP31-0AA0</b>	1	1 unit
	O + II (center, right)	2	B	<b>3SU1030-4BP61-0AA0</b>	1	1 unit

CES, SSG10	O	2	B	<b>3SU1030-5BP01-0AA0</b>	1	1 unit
	II (right)	2	B	<b>3SU1030-5BP31-0AA0</b>	1	1 unit
	O + II (center, right)	2	B	<b>3SU1030-5BP61-0AA0</b>	1	1 unit

BKS, S1	O	2	B	<b>3SU1030-5PP01-0AA0</b>	1	1 unit
---------	---	---	---	---------------------------	---	--------

Latching/momentary contact, 2x45° (10:30/12/1:30 o'clock), reset from right, latching to the left



RONIS, SB30	O	2	B	<b>3SU1030-4BN01-0AA0</b>	1	1 unit
	I	2	B	<b>3SU1030-4BN21-0AA0</b>	1	1 unit
	O+I (center, left)	2	B	<b>3SU1030-4BN51-0AA0</b>	1	1 unit

O.M.R. 73038, light blue	O	2	B	<b>3SU1030-4GN01-0AA0</b>	1	1 unit
--------------------------	---	---	---	---------------------------	---	--------

O.M.R. 73034, black	I	2	B	<b>3SU1030-4HN21-0AA0</b>	1	1 unit
---------------------	---	---	---	---------------------------	---	--------

CES, SSG10	O	2	B	<b>3SU1030-5BN01-0AA0</b>	1	1 unit
------------	---	---	---	---------------------------	---	--------

	I	2	B	<b>3SU1030-5BN21-0AA0</b>	1	1 unit
--	---	---	---	---------------------------	---	--------

	O+I (center, left)	2	B	<b>3SU1030-5BN51-0AA0</b>	1	1 unit
--	--------------------	---	---	---------------------------	---	--------



BKS, S1	O	2	B	<b>3SU1030-5PN21-0AA0</b>	1	1 unit
---------	---	---	---	---------------------------	---	--------

	O+I (center, left)	2	B	<b>3SU1030-5PN51-0AA0</b>	1	1 unit
--	--------------------	---	---	---------------------------	---	--------

IKON, 360012K1	O+I (center, left)	2	B	<b>3SU1030-5XN51-0AA0</b>	1	1 unit
----------------	--------------------	---	---	---------------------------	---	--------

#### Selection and ordering data

Operating angle	Operating principle	Switch position for key removal	Color	DT	Order No.	PU (UNIT, SET, M)	PS*
-----------------	---------------------	---------------------------------	-------	----	-----------	-------------------	-----

#### ID key-operated switches

##### 4 switch positions (O+I+II+III)



45

Latching

O+I+II+III

Black

X

**3SU1030-4WS10-0AA0**

1

1 unit

For available keys, [see page 10/143](#)

For electronic modules for ID key-operated switches, [see page 10/109](#)

# Push Button Units and Indicator Lights

## 3SU1 22 mm, Plastic with Metal Front Ring, Matte — Actuating and Signal

• Revised •  
07/15/16

### Indicator lights

#### Selection and ordering data

Version of actuating element	Color	DT	Order No.	PU (UNIT, SET, M)	PS*	
<b>Indicator lights</b>						
	Indicator lights with smooth lens	Amber	B	<b>3SU1001-6AA00-0AA0</b>	1	1 unit
		Red	A	<b>3SU1001-6AA20-0AA0</b>	1	1 unit
		Yellow	A	<b>3SU1001-6AA30-0AA0</b>	1	1 unit
		Green	A	<b>3SU1001-6AA40-0AA0</b>	1	1 unit
		Blue	A	<b>3SU1001-6AA50-0AA0</b>	1	1 unit
		White	A	<b>3SU1001-6AA60-0AA0</b>	1	1 unit
		Clear	A	<b>3SU1001-6AA70-0AA0</b>	1	1 unit
	3SU1001-6AA20-0AA0					

• Revised •  
08/31/15





# Push Button Units and Indicator Lights

## 3SU1 22 mm, Metal, Shiny — Complete Units

Pushbuttons

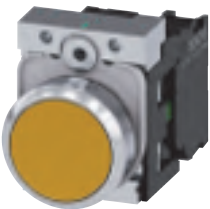
1  
2  
3  
4  
5  
6  
7  
8  
9  
10

### Selection and ordering data

Supply voltage for light source	Color	Number of NO contacts	Number of NC contacts	DT	Screw terminals	PU (UNIT, SET, M)	PS*		
								At AC	At DC
V	V				Order No.				
<b>Pushbuttons</b>									
<b>Pushbuttons with flat button, momentary contact</b>									
	--	--	Black	1	0	▶	<b>3SU1150-0AB10-1BA0</b>	1	1 unit
				0	1	▶	<b>3SU1150-0AB10-1CA0</b>	1	1 unit
			Red	1	0	B	<b>3SU1150-0AB20-1BA0</b>	1	1 unit
				0	1	▶	<b>3SU1150-0AB20-1CA0</b>	1	1 unit
			Yellow	1	0	▶	<b>3SU1150-0AB30-1BA0</b>	1	1 unit
			Green	1	0	▶	<b>3SU1150-0AB40-1BA0</b>	1	1 unit
			Blue	1	0	▶	<b>3SU1150-0AB50-1BA0</b>	1	1 unit
			White	1	0	▶	<b>3SU1150-0AB60-1BA0</b>	1	1 unit
		Clear	1	0	B	<b>3SU1150-0AB70-1BA0</b>	1	1 unit	
<b>Pushbuttons with raised button, momentary contact</b>									
	--	--	Black	1	0	B	<b>3SU1150-0BB10-1BA0</b>	1	1 unit
				0	1	B	<b>3SU1150-0BB10-1CA0</b>	1	1 unit
			Red	0	1	B	<b>3SU1150-0BB20-1CA0</b>	1	1 unit
			Blue	1	0	B	<b>3SU1150-0BB50-1BA0</b>	1	1 unit
<b>Illuminated pushbuttons with flat button, momentary contact, with integrated LED</b>									
	24	24	Amber	1	0	▶	<b>3SU1152-0AB00-1BA0</b>	1	1 unit
			Red	0	1	▶	<b>3SU1152-0AB20-1CA0</b>	1	1 unit
			Yellow	1	0	▶	<b>3SU1152-0AB30-1BA0</b>	1	1 unit
			Green	1	0	▶	<b>3SU1152-0AB40-1BA0</b>	1	1 unit
			Blue	1	0	▶	<b>3SU1152-0AB50-1BA0</b>	1	1 unit
			White	1	0	A	<b>3SU1152-0AB60-1BA0</b>	1	1 unit
			Clear	1	0	▶	<b>3SU1152-0AB70-1BA0</b>	1	1 unit
	110	--	Amber	1	0	B	<b>3SU1153-0AB00-1BA0</b>	1	1 unit
			Red	0	1	B	<b>3SU1153-0AB20-1CA0</b>	1	1 unit
			Yellow	1	0	B	<b>3SU1153-0AB30-1BA0</b>	1	1 unit
			Green	1	0	B	<b>3SU1153-0AB40-1BA0</b>	1	1 unit
			Blue	1	0	B	<b>3SU1153-0AB50-1BA0</b>	1	1 unit
			White	1	0	B	<b>3SU1153-0AB60-1BA0</b>	1	1 unit
			Clear	1	0	B	<b>3SU1153-0AB70-1BA0</b>	1	1 unit
	230	--	Amber	1	0	B	<b>3SU1156-0AB00-1BA0</b>	1	1 unit
			Red	0	1	B	<b>3SU1156-0AB20-1CA0</b>	1	1 unit
			Yellow	1	0	B	<b>3SU1156-0AB30-1BA0</b>	1	1 unit
			Green	1	0	B	<b>3SU1156-0AB40-1BA0</b>	1	1 unit
			Blue	1	0	B	<b>3SU1156-0AB50-1BA0</b>	1	1 unit
			White	1	0	B	<b>3SU1156-0AB60-1BA0</b>	1	1 unit
			Clear	1	0	B	<b>3SU1156-0AB70-1BA0</b>	1	1 unit

# Push Button Units and Indicator Lights

## 3SU1 22 mm, Metal, Shiny — Complete Units

• Revised •  
08/31/15

### Pushbuttons

Supply voltage for light source		Color	Number of NO contacts	Number of NC contacts	DT	Spring-type terminals		PU (UNIT, SET, M)	PS*
At AC	At DC								
V	V								
<b>Pushbuttons with flat button, momentary contact</b>									
--	--	Black	1	0	▶	3SU1150-0AB10-3BA0		1	1 unit
			0	1	B	3SU1150-0AB10-3CA0		1	1 unit
		Red	0	1	B	3SU1150-0AB20-3CA0		1	1 unit
		Yellow	1	0	B	3SU1150-0AB30-3BA0		1	1 unit
		Green	1	0	B	3SU1150-0AB40-3BA0		1	1 unit
		Blue	1	0	B	3SU1150-0AB50-3BA0		1	1 unit
		White	1	0	B	3SU1150-0AB60-3BA0		1	1 unit
<b>Pushbuttons with raised button, momentary contact</b>									
--	--	Red	0	1	B	3SU1150-0BB20-3CA0		1	1 unit
<b>Illuminated pushbuttons with flat button, momentary contact, with integrated LED</b>									
24	24	Red	0	1	B	3SU1152-0AB20-3CA0		1	1 unit
		Yellow	1	0	B	3SU1152-0AB30-3BA0		1	1 unit
		Green	1	0	B	3SU1152-0AB40-3BA0		1	1 unit
		Blue	1	0	B	3SU1152-0AB50-3BA0		1	1 unit
		White	1	0	B	3SU1152-0AB60-3BA0		1	1 unit
		Clear	1	0	B	3SU1152-0AB70-3BA0		1	1 unit
110	--	Red	0	1	B	3SU1153-0AB20-3CA0		1	1 unit
		Yellow	1	0	B	3SU1153-0AB30-3BA0		1	1 unit
		Green	1	0	B	3SU1153-0AB40-3BA0		1	1 unit
		Blue	1	0	B	3SU1153-0AB50-3BA0		1	1 unit
		White	1	0	B	3SU1153-0AB60-3BA0		1	1 unit
		Clear	1	0	B	3SU1153-0AB70-3BA0		1	1 unit
230	--	Red	0	1	B	3SU1156-0AB20-3CA0		1	1 unit
		Yellow	1	0	B	3SU1156-0AB30-3BA0		1	1 unit
		Green	1	0	B	3SU1156-0AB40-3BA0		1	1 unit
		Blue	1	0	B	3SU1156-0AB50-3BA0		1	1 unit
		White	1	0	B	3SU1156-0AB60-3BA0		1	1 unit
		Clear	1	0	B	3SU1156-0AB70-3BA0		1	1 unit



3SU1150-0AB40-3BA0



3SU1150-0BB20-1CA0



3SU1152-0AB50-3BA0



3SU1153-0AB60-3BA0



3SU1156-0AB30-3BA0

• Revised •  
08/31/15

# Push Button Units and Indicator Lights

## 3SU1 22 mm, Metal, Shiny — Complete Units

### Mushroom pushbuttons / EMERGENCY STOP mushroom pushbuttons

1  
2  
3  
4  
5  
6  
7  
8  
9  
10

#### Selection and ordering data

Unlatching method	Number of NO contacts	Number of NC contacts	DT	Screw terminals	PU (UNIT, SET, M)	PS*
				Order No.		

#### Mushroom pushbuttons

##### With red mushroom, diameter 40 mm, latching



3SU1150-1BA20-1CA0

Pull to unlatch	0	1		DT	3SU1150-1BA20-1CA0	1	1 unit
					Spring-type terminals		
Pull to unlatch	0	1		B	3SU1150-1BA20-3CA0	1	1 unit

#### Selection and ordering data

Unlatching method	Number of NO contacts	Number of NC contacts	Marking	DT	Screw terminals	PU (UNIT, SET, M)	PS*
					Order No.		

#### EMERGENCY STOP mushroom pushbuttons, tamper-proof, in accordance with ISO 13850 and IEC 60947-5-5

##### With red mushroom, diameter 40 mm, with positive latching



3SU1150-1HA20-1CG0

Pull to unlatch	0	1	EMERGENCY STOP		DT	3SU1150-1HA20-1CG0	1	1 unit
-----------------	---	---	----------------	--	----	--------------------	---	--------



3SU1150-1HB20-1CG0

Rotate to unlatch	0	1	EMERGENCY STOP			3SU1150-1HB20-1CG0	1	1 unit
-------------------	---	---	----------------	--	--	--------------------	---	--------



3SU1150-1HA20-3CH0

						Spring-type terminals		
Pull to unlatch	0	1	NOT-HALT	B		3SU1150-1HA20-3CH0	1	1 unit
	0	2	NOT-HALT	B		3SU1150-1HA20-3PH0	1	1 unit



3SU1150-1HB20-3CH0

Rotate to unlatch	0	1	NOT-HALT	B		3SU1150-1HB20-3CH0	1	1 unit
	0	2	NOT-HALT	B		3SU1150-1HB20-3PH0	1	1 unit









# Push Button Units and Indicator Lights

## 3SU1 22 mm, Metal, Shiny — Complete Units



• Revised •  
08/31/15

### Selector switches / key-operated switches

#### Selection and ordering data

Operating principle	Color	Number of NO contacts	Number of NC contacts	DT	Screw terminals	PU (UNIT, SET, M)	PS*
					Order No.		
<b>Selector switches</b>							
<b>Short black actuator, 2 switch positions (O+I)</b>							
 Latching, 90° 	White	1	0	▶	<b>3SU1150-2BF60-1BA0</b> <b>3SU1150-2BF60-1MA0</b>	1	1 unit
		1	1				
<b>Short black actuator, 3 switch positions (I+O+II)</b>							
 Momentary contact, 2x45° reset from left + right 	White	2	0	A	<b>3SU1150-2BM60-1NA0</b>	1	1 unit
		Latching, 2x45°	2				
<b>Spring-type terminals</b>							
<b>Short black actuator, 2 switch positions (O+I)</b>							
 Latching, 90° 	White	1	0	▶	<b>3SU1150-2BF60-3BA0</b> <b>3SU1150-2BF60-3MA0</b>	1	1 unit
		1	1				
<b>Short black actuator, 3 switch positions (I+O+II)</b>							
 Momentary contact, 2x45° reset from left + right 	White	2	0	B	<b>3SU1150-2BM60-3NA0</b>	1	1 unit
		Latching, 2x45°	2				

#### Selection and ordering data

Operating principle	Switch position for key removal	Number of NO contacts	Number of NC contacts	DT	Screw terminals	PU (UNIT, SET, M)	PS*
					Order No.		
<b>Key-operated switches</b>							
<b>With Ronis lock, SB30, 2 switch positions (O+I)</b>							
 Latching, 90° (10:30/1:30 o'clock) 	O+I	1	0	▶	<b>3SU1150-4BF11-1BA0</b> <b>Spring-type terminals</b>	1	1 unit
	O+I	1	0				
	O	0	2	B	1	1 unit	



• Revised •  
08/31/15

# Push Button Units and Indicator Lights

## 3SU1 22 mm, Metal, Shiny — Complete Units

Indicator lights

1  
2  
3  
4  
5  
6  
7  
8  
9  
10

### Selection and ordering data

Operational voltage		Color		DT	Screw terminals	PU (UNIT, SET, M)	PS*	
At AC, rated value	At DC, rated value	Of actuating element	Of light source					
V	V				Order No.			
<b>Indicator lights</b>								
<b>With smooth lens and integrated LED</b>								
	24	24	Amber	Amber	B	3SU1152-6AA00-1AA0	1	1 unit
			Red	Red	▶	3SU1152-6AA20-1AA0	1	1 unit
			Yellow	Yellow	▶	3SU1152-6AA30-1AA0	1	1 unit
			Green	Green	▶	3SU1152-6AA40-1AA0	1	1 unit
			Blue	Blue	▶	3SU1152-6AA50-1AA0	1	1 unit
			White	White	▶	3SU1152-6AA60-1AA0	1	1 unit
			Clear	White	B	3SU1152-6AA70-1AA0	1	1 unit
	110	--	Amber	Amber	B	3SU1153-6AA00-1AA0	1	1 unit
			Red	Red	A	3SU1153-6AA20-1AA0	1	1 unit
			Yellow	Yellow	B	3SU1153-6AA30-1AA0	1	1 unit
			Green	Green	A	3SU1153-6AA40-1AA0	1	1 unit
			Blue	Blue	B	3SU1153-6AA50-1AA0	1	1 unit
			White	White	B	3SU1153-6AA60-1AA0	1	1 unit
			Clear	White	B	3SU1153-6AA70-1AA0	1	1 unit
	AC 230	--	Red	Red	A	3SU1156-6AA20-1AA0	1	1 unit
			Yellow	Yellow	B	3SU1156-6AA30-1AA0	1	1 unit
			Green	Green	A	3SU1156-6AA40-1AA0	1	1 unit
			Blue	Blue	B	3SU1156-6AA50-1AA0	1	1 unit
			White	White	B	3SU1156-6AA60-1AA0	1	1 unit
			Clear	White	B	3SU1156-6AA70-1AA0	1	1 unit
<b>Spring-type terminals</b>								
	24	24	Red	Red	▶	3SU1152-6AA20-3AA0	1	1 unit
			Yellow	Yellow	▶	3SU1152-6AA30-3AA0	1	1 unit
			Green	Green	▶	3SU1152-6AA40-3AA0	1	1 unit
			Blue	Blue	▶	3SU1152-6AA50-3AA0	1	1 unit
			White	White	▶	3SU1152-6AA60-3AA0	1	1 unit
			Clear	White	B	3SU1152-6AA70-3AA0	1	1 unit
	110	--	Red	Red	B	3SU1153-6AA20-3AA0	1	1 unit
			Yellow	Yellow	B	3SU1153-6AA30-3AA0	1	1 unit
			Green	Green	B	3SU1153-6AA40-3AA0	1	1 unit
			Blue	Blue	B	3SU1153-6AA50-3AA0	1	1 unit
			White	White	B	3SU1153-6AA60-3AA0	1	1 unit
			Clear	White	B	3SU1153-6AA70-3AA0	1	1 unit
	230	--	Red	Red	B	3SU1156-6AA20-3AA0	1	1 unit
			Yellow	Yellow	B	3SU1156-6AA30-3AA0	1	1 unit
			Green	Green	B	3SU1156-6AA40-3AA0	1	1 unit
			Blue	Blue	B	3SU1156-6AA50-3AA0	1	1 unit
			White	White	B	3SU1156-6AA60-3AA0	1	1 unit
			Clear	White	B	3SU1156-6AA70-3AA0	1	1 unit



# Push Button Units and Indicator Lights

## 3SU1 22 mm, Metal, Shiny — Compact Units

• Revised •  
07/15/16

### Potentiometers

#### Selection and ordering data

Version of actuating element	Operating principle	Adjustable resistance	DT	Screw terminals 	Order No.	PU (UNIT, SET, M)	PS*
<b>Potentiometers</b>							
	Rotary knob	Stepless	1	B	<b>3SU1250-2PQ10-1AA0</b>	1	1 unit
			4.7	B	<b>3SU1250-2PR10-1AA0</b>	1	1 unit
			10	B	<b>3SU1250-2PS10-1AA0</b>	1	1 unit
			47	B	<b>3SU1250-2PT10-1AA0</b>	1	1 unit
			100	B	<b>3SU1250-2PU10-1AA0</b>	1	1 unit
			470	B	<b>3SU1250-2PV10-1AA0</b>	1	1 unit
<b>Labeling plates for potentiometers</b>							
	Black/White (label/lettering)	None	40	--	<b>3SU1900-0BG16-0AA0</b>	1	10 units
				SYMBOL: 0 ... 9	<b>3SU1900-0BG16-0RT0</b>	1	10 units
				SYMBOL: Power up	<b>3SU1900-0BG16-0RU0</b>	1	10 units

• Revised •  
07/15/16



# Push Button Units and Indicator Lights

## 3SU1 22 mm, Metal, Shiny — Compact Units

### Pushbuttons with extended stroke

1  
2  
3  
4  
5  
6  
7  
8  
9  
10

#### Selection and ordering data

Version	Color	DT	Order No.	PU (UNIT, SET, M)	PS*
<b>Pushbuttons with extended stroke</b>					
 3SU1250-0EB40-0AA0	<b>Pushbuttons with flat button</b>				
	Red	B	<b>3SU1250-0EB20-0AA0</b>	1	1 unit
	Green	B	<b>3SU1250-0EB40-0AA0</b>	1	1 unit
	Blue	B	<b>3SU1250-0EB50-0AA0</b>		
 3SU1250-0FB10-0AA0	<b>Pushbuttons with raised button</b>				
	Black	A	<b>3SU1250-0FB10-0AA0</b>	1	1 unit
 3SU1251-0EB20-0AA0	<b>Illuminated pushbuttons with flat button</b>				
	Red	B	<b>3SU1251-0EB20-0AA0</b>	1	1 unit
	Clear	B	<b>3SU1251-0EB70-0AA0</b>	1	1 unit

Version	Material	Color	DT	Order No.	PU (UNIT, SET, M)	PS*
---------	----------	-------	----	-----------	-------------------------	-----

<b>Accessories</b>						
 3SU1900-0KG10-0AA0	<b>Extension plungers</b>	Plastic	Black	A	<b>3SU1900-0KG10-0AA0</b>	1 1 unit
	For compensation of the distance between the pushbutton and the unlatching button of an overload relay					





# Push Button Units and Indicator Lights

## 3SU1 22 mm, Metal, Shiny — Compact Units

• Revised •  
08/31/15

### Pushbuttons

#### Selection and ordering data

Version of actuating element Front ring version	Operating principle Unlatching method	Color, marking	DT	Order No.	PU (UNIT, SET, M)	PS*	
<b>Pushbuttons</b>							
 3SU1050-0AB40-0AC0   3SU1050-0AA30-0AA0	<b>Pushbuttons</b> with flat button Standard	Momentary contact	Black ▶	3SU1050-0AB10-0AA0	1	1 unit	
			Black, O	B	3SU1050-0AB10-0AD0	1	1 unit
			Red ▶		3SU1050-0AB20-0AA0	1	1 unit
			Red, O	B	3SU1050-0AB20-0AD0	1	1 unit
			Yellow ▶		3SU1050-0AB30-0AA0	1	1 unit
			Green ▶		3SU1050-0AB40-0AA0	1	1 unit
			Green, I	B	3SU1050-0AB40-0AC0	1	1 unit
			Blue ▶		3SU1050-0AB50-0AA0	1	1 unit
			Blue, R	B	3SU1050-0AB50-0AR0	1	1 unit
			White ▶		3SU1050-0AB60-0AA0	1	1 unit
			White, ⊕	B	3SU1050-0AB60-0AB0	1	1 unit
			White, I	B	3SU1050-0AB60-0AC0	1	1 unit
			Clear ▶		3SU1050-0AB70-0AA0	1	1 unit
			Gray ▶		3SU1050-0AB80-0AA0	1	1 unit
			Latching Push to unlatch	Black ▶	3SU1050-0AA10-0AA0	1	1 unit
		Red ▶	3SU1050-0AA20-0AA0	1	1 unit		
		Yellow ▶	3SU1050-0AA30-0AA0	1	1 unit		
		Green ▶	3SU1050-0AA40-0AA0	1	1 unit		
		Blue ▶	3SU1050-0AA50-0AA0	1	1 unit		
		White ▶	3SU1050-0AA60-0AA0	1	1 unit		
 3SU1050-0BB20-0AA0	<b>Pushbuttons</b> with raised button Standard	Momentary contact	Black ▶	3SU1050-0BB10-0AA0	1	1 unit	
			Red ▶	3SU1050-0BB20-0AA0	1	1 unit	
			Yellow ▶	3SU1050-0BB30-0AA0	1	1 unit	
			Green ▶	3SU1050-0BB40-0AA0	1	1 unit	
			Blue ▶	3SU1050-0BB50-0AA0	1	1 unit	
			White ▶	3SU1050-0BB60-0AA0	1	1 unit	
			Latching Push to unlatch	Red	B	3SU1050-0BA20-0AA0	1
 3SU1050-0CB50-0AA0	<b>Pushbuttons</b> with flat button Raised	Momentary contact	Black ▶	3SU1050-0CB10-0AA0	1	1 unit	
			Red	B	3SU1050-0CB20-0AA0	1	1 unit
			Yellow	B	3SU1050-0CB30-0AA0	1	1 unit
			Green	B	3SU1050-0CB40-0AA0	1	1 unit
			Blue ▶		3SU1050-0CB50-0AA0	1	1 unit
			White	B	3SU1050-0CB60-0AA0	1	1 unit



• Revised •  
08/31/15

# Push Button Units and Indicator Lights

## 3SU1 22 mm, Metal, Shiny — Actuating and Signaling Elements

### Pushbuttons

1  
2  
3  
4  
5  
6  
7  
8  
9  
10

Version of actuating element Front ring version	Operating principle Unlatching method	Color	DT	Order No.	PU (UNIT, SET, M)	PS*
<b>Pushbuttons</b>						
 3SU1051-0AB30-0AA0	<b>Illuminated pushbuttons</b> with flat button Standard	Momentary contact	Amber ▶	3SU1051-0AB00-0AA0	1	1 unit
			Red ▶	3SU1051-0AB20-0AA0	1	1 unit
			Yellow ▶	3SU1051-0AB30-0AA0	1	1 unit
			Green ▶	3SU1051-0AB40-0AA0	1	1 unit
			Blue ▶	3SU1051-0AB50-0AA0	1	1 unit
			White ▶	3SU1051-0AB60-0AA0	1	1 unit
			Clear ▶	3SU1051-0AB70-0AA0	1	1 unit
	 3SU1051-0AA20-0AA0	Latching Push to unlatch	Red ▶	3SU1051-0AA20-0AA0	1	1 unit
			Yellow B	3SU1051-0AA30-0AA0	1	1 unit
			Green ▶	3SU1051-0AA40-0AA0	1	1 unit
 3SU1051-0BB20-0AA0	<b>Illuminated pushbuttons</b> with raised button Standard	Momentary contact	Amber ▶	3SU1051-0BB00-0AA0	1	1 unit
			Red ▶	3SU1051-0BB20-0AA0	1	1 unit
			Yellow ▶	3SU1051-0BB30-0AA0	1	1 unit
			Green ▶	3SU1051-0BB40-0AA0	1	1 unit
			Blue ▶	3SU1051-0BB50-0AA0	1	1 unit
			White ▶	3SU1051-0BB60-0AA0	1	1 unit
			Clear B	3SU1051-0BB70-0AA0	1	1 unit





# Push Button Units and Indicator Lights

## 3SU1 22 mm, Metal, Shiny — Actuating and Signaling Elements

• Revised •  
07/15/16

### Twin pushbuttons

#### Selection and ordering data

Version of actuating element	Operating principle	Color	Marking	DT	Order No.	PU (UNIT, SET, M)	PS*	
<b>Twin pushbuttons</b>								
 <p>3SU1050-3AB66-0AL0</p>	Twin pushbuttons, flat, flat	Momentary contact	Green / Red	--	B	<b>3SU1050-3AB42-0AA0</b>	1	1 unit
				/ O	▶	<b>3SU1050-3AB42-0AK0</b>	1	1 unit
			White / Black	--	B	<b>3SU1050-3AB61-0AA0</b>	1	1 unit
				/ O	B	<b>3SU1050-3AB61-0AK0</b>	1	1 unit
			White / White	--	B	<b>3SU1050-3AB66-0AA0</b>	1	1 unit
				- / +	B	<b>3SU1050-3AB66-0AL0</b>	1	1 unit
				Arrows, hor.	B	<b>3SU1050-3AB66-0AM0</b>	1	1 unit
			Black / Black	--	B	<b>3SU1050-3AB11-0AA0</b>	1	1 unit
				○ ○	B	<b>3SU1050-3AB11-0AQ0</b>	1	1 unit
						5264 / 5265 (IEC 60417)		
 <p>3SU1050-3BB42-0AK0</p>	Twin pushbuttons, flat, raised	Momentary contact	Green / Red	--	B	<b>3SU1050-3BB42-0AA0</b>	1	1 unit
				/ O	▶	<b>3SU1050-3BB42-0AK0</b>	1	1 unit
			White / Black	--	B	<b>3SU1050-3BB61-0AA0</b>	1	1 unit
				/ O	B	<b>3SU1050-3BB61-0AK0</b>	1	1 unit
 <p>3SU1051-3AB42-0AN0</p>	Twin pushbuttons, flat, flat, illuminated	Momentary contact	Green / Red	--	B	<b>3SU1051-3AB42-0AA0</b>	1	1 unit
				/ O	▶	<b>3SU1051-3AB42-0AK0</b>	1	1 unit
				Arrows, vert.	B	<b>3SU1051-3AB42-0AN0</b>	1	1 unit
			White / Black	--	B	<b>3SU1051-3AB61-0AA0</b>	1	1 unit
				/ O	▶	<b>3SU1051-3AB61-0AK0</b>	1	1 unit
 <p>3SU1051-3BB61-0AA0</p>	Twin pushbuttons, flat, raised, illuminated	Momentary contact	Green / Red	--	B	<b>3SU1051-3BB42-0AA0</b>	1	1 unit
				/ O	▶	<b>3SU1051-3BB42-0AK0</b>	1	1 unit
			White / Black	--	B	<b>3SU1051-3BB61-0AA0</b>	1	1 unit
				/ O	B	<b>3SU1051-3BB61-0AK0</b>	1	1 unit

• Revised •  
08/31/15

# Push Button Units and Indicator Lights

## 3SU1 22 mm, Metal, Shiny — Actuating and Signaling Elements

### Mushroom pushbuttons

1  
2  
3  
4  
5  
6  
7  
8  
9  
10

#### Selection and ordering data

Version of actuating element	Operating principle Unlatching method	Color	DT	Order No.	PU (UNIT, SET, M)	PS*
------------------------------	--	-------	----	-----------	-------------------------	-----







Mushroom pushbuttons							
	<b>2 switch positions</b>						
	<b>Mushroom pushbuttons</b> 30 mm diameter, 2 positions	Momentary contact	Black	▶	<b>3SU1050-1AD10-0AA0</b>	1	1 unit
			Red	▶	<b>3SU1050-1AD20-0AA0</b>	1	1 unit
			Yellow	▶	<b>3SU1050-1AD30-0AA0</b>	1	1 unit
			Green	B	<b>3SU1050-1AD40-0AA0</b>	1	1 unit
		Latching	Black	B	<b>3SU1050-1AA10-0AA0</b>	1	1 unit
	Pull to unlatch	Red	▶	<b>3SU1050-1AA20-0AA0</b>	1	1 unit	
	<b>Mushroom pushbuttons</b> 40 mm diameter, 2 positions	Momentary contact	Black	▶	<b>3SU1050-1BD10-0AA0</b>	1	1 unit
			Red	▶	<b>3SU1050-1BD20-0AA0</b>	1	1 unit
			Yellow	▶	<b>3SU1050-1BD30-0AA0</b>	1	1 unit
			Green	B	<b>3SU1050-1BD40-0AA0</b>	1	1 unit
		Latching	Black	▶	<b>3SU1050-1BA10-0AA0</b>	1	1 unit
		Pull to unlatch	Red	▶	<b>3SU1050-1BA20-0AA0</b>	1	1 unit
		Yellow	B	<b>3SU1050-1BA30-0AA0</b>	1	1 unit	
	<b>Mushroom pushbuttons</b> 60 mm diameter, 2 positions	Momentary contact	Black	▶	<b>3SU1050-1CD10-0AA0</b>	1	1 unit
			Red	▶	<b>3SU1050-1CD20-0AA0</b>	1	1 unit
			Yellow	B	<b>3SU1050-1CD30-0AA0</b>	1	1 unit
			Green	B	<b>3SU1050-1CD40-0AA0</b>	1	1 unit
		Latching	Black	B	<b>3SU1050-1CA10-0AA0</b>	1	1 unit
		Pull to unlatch	Red	B	<b>3SU1050-1CA20-0AA0</b>	1	1 unit
	<b>Mushroom pushbuttons</b> 30 mm diameter, 2 positions, illuminated	Momentary contact	Yellow	B	<b>3SU1051-1AD30-0AA0</b>	1	1 unit
			Green	B	<b>3SU1051-1AD40-0AA0</b>	1	1 unit
			White	B	<b>3SU1051-1AD60-0AA0</b>	1	1 unit
		Latching	Amber	▶	<b>3SU1051-1AA00-0AA0</b>	1	1 unit
			Red	▶	<b>3SU1051-1AA20-0AA0</b>	1	1 unit
			Yellow	▶	<b>3SU1051-1AA30-0AA0</b>	1	1 unit
			Green	B	<b>3SU1051-1AA40-0AA0</b>	1	1 unit
			Blue	B	<b>3SU1051-1AA50-0AA0</b>	1	1 unit
			Clear	▶	<b>3SU1051-1AA70-0AA0</b>	1	1 unit
		Pull to unlatch					
	<b>Mushroom pushbuttons</b> 40 mm diameter, 2 positions, illuminated	Momentary contact	Amber	▶	<b>3SU1051-1BD00-0AA0</b>	1	1 unit
			Yellow	B	<b>3SU1051-1BD30-0AA0</b>	1	1 unit
			Green	B	<b>3SU1051-1BD40-0AA0</b>	1	1 unit
			White	B	<b>3SU1051-1BD60-0AA0</b>	1	1 unit
		Latching	Amber	B	<b>3SU1051-1BA00-0AA0</b>	1	1 unit
			Red	B	<b>3SU1051-1BA20-0AA0</b>	1	1 unit
			Yellow	B	<b>3SU1051-1BA30-0AA0</b>	1	1 unit
			Green	B	<b>3SU1051-1BA40-0AA0</b>	1	1 unit
			Blue	B	<b>3SU1051-1BA50-0AA0</b>	1	1 unit
			Clear	B	<b>3SU1051-1BA70-0AA0</b>	1	1 unit
	<b>Mushroom pushbuttons</b> 60 mm diameter, 2 positions, illuminated	Momentary contact	Amber	B	<b>3SU1051-1CD00-0AA0</b>	1	1 unit
			Yellow	B	<b>3SU1051-1CD30-0AA0</b>	1	1 unit
			Green	B	<b>3SU1051-1CD40-0AA0</b>	1	1 unit
			White	B	<b>3SU1051-1CD60-0AA0</b>	1	1 unit
		Latching	Red	B	<b>3SU1051-1CA20-0AA0</b>	1	1 unit
			Yellow	B	<b>3SU1051-1CA30-0AA0</b>	1	1 unit
			Green	B	<b>3SU1051-1CA40-0AA0</b>	1	1 unit
			Blue	B	<b>3SU1051-1CA50-0AA0</b>	1	1 unit
			Clear	B	<b>3SU1051-1CA70-0AA0</b>	1	1 unit
		Pull to unlatch					

# Push Button Units and Indicator Lights



## 3SU1 22 mm, Metal, Shiny — Actuating and Signaling Elements

• Revised •  
08/31/15

### Mushroom pushbuttons / EMERGENCY STOP mushroom pushbuttons

Version of actuating element	Operating principle Unlatching method	Color	DT	Order No.	PU (UNIT, SET, M)	PS*
<b>Mushroom pushbuttons</b>						
<b>2 switch positions</b>						
 3SU1050-1HB10-0AA0	<b>Mushroom pushbuttons</b> with raised mushroom, tamper-proof 40 mm diameter, 2 positions	Latching Rotate to unlatch	Black	B	<b>3SU1050-1HB10-0AA0</b>	1 1 unit
	<b>3 switch positions</b>					
 3SU1050-1EA20-0AA0	<b>Mushroom pushbuttons</b> 40 mm diameter, 3 positions	Momentary contact 	Black Red	B B	<b>3SU1050-1ED10-0AA0</b> <b>3SU1050-1ED20-0AA0</b>	1 1 unit 1 1 unit
		Latching  Pull to unlatch	Black Red	B B	<b>3SU1050-1EA10-0AA0</b> <b>3SU1050-1EA20-0AA0</b>	1 1 unit 1 1 unit
 3SU1051-1EA40-0AA0	<b>Mushroom pushbuttons</b> 40 mm diameter, 3 positions, illuminated	Momentary contact 	Red White	B B	<b>3SU1051-1ED20-0AA0</b> <b>3SU1051-1ED60-0AA0</b>	1 1 unit 1 1 unit
		Latching  Pull to unlatch	Red Green	B B	<b>3SU1051-1EA20-0AA0</b> <b>3SU1051-1EA40-0AA0</b>	1 1 unit 1 1 unit

### Selection and ordering data

Version of actuating element	Outer diameter of mushroom	Make of lock	Color	DT	Order No.	PU (UNIT, SET, M)	PS*
<b>EMERGENCY STOP mushroom pushbuttons</b>							
<b>With pull-to-unlatch mechanism</b>							
 3SU1050-1HA20-0AA0	40	--	Red	▶	<b>3SU1050-1HA20-0AA0</b>	1	1 unit
					<b>With rotate-to-unlatch mechanism</b>		
 3SU1050-1GB20-0AA0	33.8	--	Red	▶	<b>3SU1050-1GB20-0AA0</b>	1	1 unit



• Revised •  
07/15/16

# Push Button Units and Indicator Lights

## 3SU1 22 mm, Metal, Shiny — Actuating and Signaling Elements

### EMERGENCY STOP mushroom pushbuttons

1  
2  
3  
4  
5  
6  
7  
8  
9  
10

Version of actuating element	Outer diameter of mushroom	Make of lock	Color	DT	Order No.	PU (UNIT, SET, M)	PS*
------------------------------	----------------------------	--------------	-------	----	-----------	-------------------	-----

#### EMERGENCY STOP mushroom pushbuttons

##### With rotate-to-unlatch mechanism



3SU1050-1HB20-0AA0

**EMERGENCY STOP mushroom pushbuttons** tamper-proof, 2 positions

40	--	Red	▶	<b>3SU1050-1HB20-0AA0</b>	1	1 unit
----	----	-----	---	---------------------------	---	--------



3SU1050-1JB20-0AA0

60	--	Red	▶	<b>3SU1050-1JB20-0AA0</b>	1	1 unit
----	----	-----	---	---------------------------	---	--------

##### With rotate-to-unlatch mechanism, can be illuminated



3SU1051-1HB20-0AA0

**EMERGENCY STOP mushroom pushbuttons** tamper-proof, 2 positions

33.8	--	Red	B	<b>3SU1051-1GB20-0AA0</b>	1	1 unit
40	--	Red	B	<b>3SU1051-1HB20-0AA0</b>	1	1 unit
60	--	Red	B	<b>3SU1051-1JB20-0AA0</b>	1	1 unit

##### With key-operated release



3SU1050-1HF20-0AA0

**EMERGENCY STOP mushroom pushbuttons** tamper-proof, 2 positions

40	RONIS SB30	Red	▶	<b>3SU1050-1HF20-0AA0</b>	1	1 unit
	RONIS 455		B	<b>3SU1050-1HG20-0AA0</b>	1	1 unit
	RONIS 421		B	<b>3SU1050-1HH20-0AA0</b>	1	1 unit



3SU1050-1HQ20-0AA0

	BKS S1		B	<b>3SU1050-1HK20-0AA0</b>	1	1 unit
	O.M.R. 73037		▶	<b>3SU1050-1HQ20-0AA0</b>	1	1 unit



3SU1050-1HR20-0AA0

	CES SSG10		▶	<b>3SU1050-1HR20-0AA0</b>	1	1 unit
	CES SSP9		B	<b>3SU1050-1HS20-0AA0</b>	1	1 unit
	CES VL5	Black	B	<b>3SU1050-1HU10-0AA0</b>	1	1 unit
		Red	B	<b>3SU1050-1HU20-0AA0</b>	1	1 unit
	CES VL1		B	<b>3SU1050-1HV20-0AA0</b>	1	1 unit
	IKON 360012K1		B	<b>3SU1050-1HX20-0AA0</b>	1	1 unit

# Push Button Units and Indicator Lights

## 3SU1 22 mm, Metal, Shiny — Actuating and Signaling Elements









• Revised •  
07/15/16

### Toggle switches / Selector switches

#### Selection and ordering data

	Number of switching positions	Number of command points	Color of actuating element	Operating principle of the actuating element	DT	Order No.	PU (UNIT, SET, M)	PS*
<b>Toggle switches</b>								
	2	1	Black	Latching	B	<b>3SU1050-3EA10-0AA0</b>	1	1 unit
				Momentary contact Reset from above	B	<b>3SU1050-3EC10-0AA0</b>	1	1 unit

#### Selection and ordering data

	Version of actuator	Operating principle	Color	DT	Order No.	PU (UNIT, SET, M)	PS*	
<b>Selector switches</b>								
<b>2 switch positions, can be illuminated</b>								
	Selector, short black actuator	Momentary contact, 45° (10:30/12 o'clock), reset from center to left 	Black	B	<b>3SU1052-2BC10-0AA0</b>	1	1 unit	
			Red	B	<b>3SU1052-2BC20-0AA0</b>	1	1 unit	
			Yellow	B	<b>3SU1052-2BC30-0AA0</b>	1	1 unit	
			Green	B	<b>3SU1052-2BC40-0AA0</b>	1	1 unit	
			Blue	B	<b>3SU1052-2BC50-0AA0</b>	1	1 unit	
			White	B	<b>3SU1052-2BC60-0AA0</b>	1	1 unit	
	Selector, long black actuator	Latching, 90° (10:30/1:30 o'clock) 	Amber	B	<b>3SU1052-2BF00-0AA0</b>	1	1 unit	
			Black	B	<b>3SU1052-2BF10-0AA0</b>	1	1 unit	
			Red	B	<b>3SU1052-2BF20-0AA0</b>	1	1 unit	
			Green	B	<b>3SU1052-2BF40-0AA0</b>	1	1 unit	
			White	▶	<b>3SU1052-2BF60-0AA0</b>	1	1 unit	
	Selector, long black actuator	Momentary contact, 45° (10:30/12 o'clock), reset from center to left 	Black	B	<b>3SU1052-2CC10-0AA0</b>	1	1 unit	
			Yellow	B	<b>3SU1052-2CC30-0AA0</b>	1	1 unit	
			Green	B	<b>3SU1052-2CC40-0AA0</b>	1	1 unit	
			Blue	B	<b>3SU1052-2CC50-0AA0</b>	1	1 unit	
			White	B	<b>3SU1052-2CC60-0AA0</b>	1	1 unit	
	Selector, long black actuator	Latching, 90° (10:30/1:30 o'clock) 	Black	B	<b>3SU1052-2CF10-0AA0</b>	1	1 unit	
			Red	B	<b>3SU1052-2CF20-0AA0</b>	1	1 unit	
			Yellow	B	<b>3SU1052-2CF30-0AA0</b>	1	1 unit	
			Green	B	<b>3SU1052-2CF40-0AA0</b>	1	1 unit	
			Blue	B	<b>3SU1052-2CF50-0AA0</b>	1	1 unit	
			White	B	<b>3SU1052-2CF60-0AA0</b>	1	1 unit	

• Revised •  
07/15/16

# Push Button Units and Indicator Lights

## 3SU1 22 mm, Metal, Shiny — Actuating and Signaling Elements

### Selector switches

1

2

3

4

5

6

7

8

9

10

Version of actuator	Operating principle	Color	DT	Order No.	PU (UNIT, SET, M)	PS*
---------------------	---------------------	-------	----	-----------	-------------------	-----

#### Selector switches

#### 3 switch positions, can be illuminated



3SU1052-2BM50-0AA0

Selector, short black actuator

Momentary contact, 2x45° (10:30/12/1:30 o'clock), Reset from right + left



Amber	B	<b>3SU1052-2BM00-0AA0</b>
Black	B	<b>3SU1052-2BM10-0AA0</b>
Red	B	<b>3SU1052-2BM20-0AA0</b>
Yellow	B	<b>3SU1052-2BM30-0AA0</b>
Green	B	<b>3SU1052-2BM40-0AA0</b>
Blue	B	<b>3SU1052-2BM50-0AA0</b>
White	▶	<b>3SU1052-2BM60-0AA0</b>

1	1 unit
1	1 unit
1	1 unit
1	1 unit
1	1 unit
1	1 unit
1	1 unit



3SU1052-2BL30-0AA0

Latching, 2x45° (10:30/12/1:30 o'clock)



Black	B	<b>3SU1052-2BL10-0AA0</b>
Red	B	<b>3SU1052-2BL20-0AA0</b>
Yellow	B	<b>3SU1052-2BL30-0AA0</b>
Green	B	<b>3SU1052-2BL40-0AA0</b>
White	▶	<b>3SU1052-2BL60-0AA0</b>

1	1 unit
1	1 unit
1	1 unit
1	1 unit
1	1 unit



3SU1052-2BN20-0AA0

Selector, short black actuator

Momentary contact/latching, 2x45° (10:30/12/1:30 o'clock), reset from left, latching to right



Black	B	<b>3SU1052-2BP10-0AA0</b>
White	B	<b>3SU1052-2BP60-0AA0</b>

1	1 unit
1	1 unit



3SU1052-2CL40-0AA0

Selector, long black actuator

Momentary contact, 2x45° (10:30/12/1:30 o'clock), Reset from right + left



Black	B	<b>3SU1052-2CM10-0AA0</b>
Red	B	<b>3SU1052-2CM20-0AA0</b>
Green	B	<b>3SU1052-2CM40-0AA0</b>
White	▶	<b>3SU1052-2CM60-0AA0</b>

1	1 unit
1	1 unit
1	1 unit
1	1 unit

Latching, 2x45° (10:30/12/1:30 o'clock)



Black	B	<b>3SU1052-2CL10-0AA0</b>
Red	B	<b>3SU1052-2CL20-0AA0</b>
Green	B	<b>3SU1052-2CL40-0AA0</b>
White	▶	<b>3SU1052-2CL60-0AA0</b>

1	1 unit
1	1 unit
1	1 unit
1	1 unit

Momentary contact/ latching, 2x45° (10:30/12/1:30 o'clock), reset from left, latching to right



Black	B	<b>3SU1052-2CP10-0AA0</b>
Red	B	<b>3SU1052-2CP20-0AA0</b>
White	▶	<b>3SU1052-2CP60-0AA0</b>

1	1 unit
1	1 unit
1	1 unit

Latching/momentary contact, 2x45° (10:30/12/1:30 o'clock), reset from right, latching to left



Black	B	<b>3SU1052-2CN10-0AA0</b>
Red	B	<b>3SU1052-2CN20-0AA0</b>
White	▶	<b>3SU1052-2CN60-0AA0</b>

1	1 unit
1	1 unit
1	1 unit

#### 4 switch positions



3SU1050-2AS60-0AA0

Rotary knob

Latching, 4x90°, (0-position: 3/6/9/12 o'clock)



White	B	<b>3SU1050-2AS60-0AA0</b>
-------	---	---------------------------

1	1 unit
---	--------













# Push Button Units and Indicator Lights

## 3SU1 22 mm, Metal, Shiny — Actuating and Signaling Elements

• Revised •  
07/15/16

### Key-operated switches

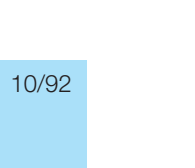
#### Selection and ordering data

Operating principle	Make of lock	Switch position for key removal	Number of keys	DT	Order No.	PU (UNIT, SET, M)	PS*			
<b>Key-operated switches</b>										
<b>2 switch positions (O+I)</b>										
 <p>3SU1050-4BC01-0AA0</p>	Momentary contact, 45° (10:30/12 o'clock), reset from center to left 	RONIS, SB30	O	2	▶	<b>3SU1050-4BC01-0AA0</b>	1	1 unit		
		RONIS, 455	O	2	B	<b>3SU1050-4CC01-0AA0</b>	1	1 unit		
		O.M.R. 73037, red	O	2	B	<b>3SU1050-4FC01-0AA0</b>	1	1 unit		
		O.M.R. 73038, light blue	O	2	B	<b>3SU1050-4GC01-0AA0</b>	1	1 unit		
		O.M.R. 73034, black	O	2	B	<b>3SU1050-4HC01-0AA0</b>	1	1 unit		
		O.M.R. 73033, yellow	O	2	B	<b>3SU1050-4JC01-0AA0</b>	1	1 unit		
		CES, SSG10	O	2	▶	<b>3SU1050-5BC01-0AA0</b>	1	1 unit		
		CES, LSG1	O	2	B	<b>3SU1050-5HC01-0AA0</b>	1	1 unit		
		CES, VL5	O	2	B	<b>3SU1050-5KC01-0AA0</b>	1	1 unit		
		CES, STGH10	O	2	B	<b>3SU1050-5LC01-0AA0</b>	1	1 unit		
		BKS, S1	O	2	B	<b>3SU1050-5PC01-0AA0</b>	1	1 unit		
		IKON, 360012K1	O	2	B	<b>3SU1050-5XC01-0AA0</b>	1	1 unit		
		 <p>3SU1050-4BF01-0AA0</p>	Latching, 90° (10:30/1:30 o'clock) 	RONIS, SB30	O	2	B	<b>3SU1050-4BF01-0AA0</b>	1	1 unit
					O+I	2	B	<b>3SU1050-4BF11-0AA0</b>	1	1 unit
	I			2	B	<b>3SU1050-4BF21-0AA0</b>	1	1 unit		
RONIS, 455	O			2	B	<b>3SU1050-4CF01-0AA0</b>	1	1 unit		
	O+I			2	B	<b>3SU1050-4CF11-0AA0</b>	1	1 unit		
	I			2	B	<b>3SU1050-4CF21-0AA0</b>	1	1 unit		
RONIS, 421	O+I			2	B	<b>3SU1050-4DF11-0AA0</b>	1	1 unit		
O.M.R. 73037, red	O			2	B	<b>3SU1050-4FF01-0AA0</b>	1	1 unit		
	O+I			2	B	<b>3SU1050-4FF11-0AA0</b>	1	1 unit		
	I			2	B	<b>3SU1050-4FF21-0AA0</b>	1	1 unit		
 <p>3SU1050-4GF11-0AA0</p>	O.M.R. 73038, light blue 	O	2	B	<b>3SU1050-4GF01-0AA0</b>	1	1 unit			
		O+I	2	B	<b>3SU1050-4GF11-0AA0</b>	1	1 unit			
			I	2	B	<b>3SU1050-4GF21-0AA0</b>	1	1 unit		
		O.M.R. 73034, black	O	2	▶	<b>3SU1050-4HF01-0AA0</b>	1	1 unit		
		O+I	2	B	<b>3SU1050-4HF11-0AA0</b>	1	1 unit			
			I	2	B	<b>3SU1050-4HF21-0AA0</b>	1	1 unit		
		O.M.R. 73033, yellow	O	2	B	<b>3SU1050-4JF01-0AA0</b>	1	1 unit		
		O+I	2	B	<b>3SU1050-4JF11-0AA0</b>	1	1 unit			
			I	2	B	<b>3SU1050-4JF21-0AA0</b>	1	1 unit		
		 <p>3SU1050-5BF01-0AA0</p>	CES, SSG10 	O	2	▶	<b>3SU1050-5BF01-0AA0</b>	1	1 unit	
O+I	2			▶	<b>3SU1050-5BF11-0AA0</b>	1	1 unit			
	I			2	▶	<b>3SU1050-5BF21-0AA0</b>	1	1 unit		
CES, LSG1	O			2	B	<b>3SU1050-5HF01-0AA0</b>	1	1 unit		
O+I	2			B	<b>3SU1050-5HF11-0AA0</b>	1	1 unit			
CES, VL5	O			2	B	<b>3SU1050-5KF01-0AA0</b>	1	1 unit		
CES, STGH10	O+I			2	▶	<b>3SU1050-5LF11-0AA0</b>	1	1 unit		
 <p>3SU1050-5PF01-0AA0</p>	BKS, S1 			O	2	B	<b>3SU1050-5PF01-0AA0</b>	1	1 unit	
				O+I	2	B	<b>3SU1050-5PF11-0AA0</b>	1	1 unit	
				I	2	B	<b>3SU1050-5PF21-0AA0</b>	1	1 unit	
 <p>3SU1050-5XF01-0AA0</p>	IKON, 360012K1 	O	2	B	<b>3SU1050-5XF01-0AA0</b>	1	1 unit			
		O+I	2	B	<b>3SU1050-5XF11-0AA0</b>	1	1 unit			

• Revised •  
08/31/15







# Push Button Units and Indicator Lights

## 3SU1 22 mm, Metal, Shiny — Actuating and Signaling Elements

### Key-operated switches

1  
2  
3  
4  
5  
6  
7  
8  
9  
10

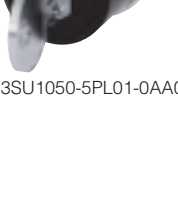
#### Selection and ordering data

Operating principle	Make of lock	Switch position for key removal	Number of keys	DT	Order No.	PU (UNIT, SET, M)	PS*	
<b>Key-operated switches</b>								
<b>3 switch positions (I+O+II)</b>								
 3SU1050-4BM01-0AA0 Momentary contact, 2x45° (10:30/12/1:30 o'clock), reset from left + right 	RONIS, SB30	O	2	B	<b>3SU1050-4BM01-0AA0</b>	1	1 unit	
	RONIS, 455	O	2	B	<b>3SU1050-4CM01-0AA0</b>	1	1 unit	
	O.M.R. 73034, black	O	2	B	<b>3SU1050-4HM01-0AA0</b>	1	1 unit	
	CES, SSG10	O	2	B	<b>3SU1050-5BM01-0AA0</b>	1	1 unit	
	CES, STGH10	O	2	B	<b>3SU1050-5LM01-0AA0</b>	1	1 unit	
	BKS, S1	O	2	B	<b>3SU1050-5PM01-0AA0</b>	1	1 unit	
	IKON, 360012K1	O	2	B	<b>3SU1050-5XM01-0AA0</b>	1	1 unit	
	 3SU1050-4FL11-0AA0 Latching, 2x45° (10:30/12/1:30 o'clock) 	RONIS, SB30	O	2	B	<b>3SU1050-4BL01-0AA0</b>	1	1 unit
			I+O+II	2	▶	<b>3SU1050-4BL11-0AA0</b>	1	1 unit
			I	2	B	<b>3SU1050-4BL21-0AA0</b>	1	1 unit
		II (right)	2	B	<b>3SU1050-4BL31-0AA0</b>	1	1 unit	
		I+II (left, right)	2	B	<b>3SU1050-4BL41-0AA0</b>	1	1 unit	
		O+I (center, left)	2	B	<b>3SU1050-4BL51-0AA0</b>	1	1 unit	
RONIS, 455		O	2	B	<b>3SU1050-4CL01-0AA0</b>	1	1 unit	
		I+O+II	2	B	<b>3SU1050-4CL11-0AA0</b>	1	1 unit	
RONIS, 421			2	B	<b>3SU1050-4DL11-0AA0</b>	1	1 unit	
O.M.R. 73037, red		I+O+II	2	B	<b>3SU1050-4FL11-0AA0</b>	1	1 unit	
 3SU1050-4GL11-0AA0 O.M.R. 73038, light blue O.M.R. 73034, black I+O+II	O	2	B	<b>3SU1050-4GL01-0AA0</b>	1	1 unit		
	I+O+II	2	B	<b>3SU1050-4GL11-0AA0</b>	1	1 unit		
	O	2	B	<b>3SU1050-4HL01-0AA0</b>	1	1 unit		
	I+O+II	2	B	<b>3SU1050-4HL11-0AA0</b>	1	1 unit		
 3SU1050-5BL01-0AA0 CES, SSG10 O I+O+II I II (right) I+II (left, right)	O	2	▶	<b>3SU1050-5BL01-0AA0</b>	1	1 unit		
	I+O+II	2	▶	<b>3SU1050-5BL11-0AA0</b>	1	1 unit		
	I	2	▶	<b>3SU1050-5BL21-0AA0</b>	1	1 unit		
	II (right)	2	▶	<b>3SU1050-5BL31-0AA0</b>	1	1 unit		
	I+II (left, right)	2	▶	<b>3SU1050-5BL41-0AA0</b>	1	1 unit		
 3SU1050-5PL01-0AA0 BKS, S1 O I+O+II I I+II (left, right)	O	2	B	<b>3SU1050-5PL01-0AA0</b>	1	1 unit		
	I+O+II	2	B	<b>3SU1050-5PL11-0AA0</b>	1	1 unit		
	I	2	B	<b>3SU1050-5PL21-0AA0</b>	1	1 unit		
	I+II (left, right)	2	B	<b>3SU1050-5PL41-0AA0</b>	1	1 unit		
IKON, 360012K1 O I+O+II	O	2	B	<b>3SU1050-5XL01-0AA0</b>	1	1 unit		
	I+O+II	2	B	<b>3SU1050-5XL11-0AA0</b>	1	1 unit		



# Push Button Units and Indicator Lights

## 3SU1 22 mm, Metal, Shiny — Actuating and Signaling Elements

• Revised •  
08/31/15

### Key-operated switches / Indicator lights

#### Selection and ordering data

Operating principle	Make of lock	Switch position for key removal	Number of keys	DT	Order No.	PU (UNIT, SET, M)	PS*	
<b>Key-operated switches</b>								
<b>3 switch positions (I+O+II)</b>								
 <p>3SU1050-4BP01-0AA0</p> <p>Momentary contact/latching, 2x45° (10:30/12/1:30 o'clock), reset from left, latching to the right</p> 	RONIS, SB30	O	2	B	<b>3SU1050-4BP01-0AA0</b>	1	1 unit	
		O+II (center, right)	2	B	<b>3SU1050-4BP61-0AA0</b>	1	1 unit	
		O.M.R. 73034, black	II (right)	2	B	<b>3SU1050-4HP31-0AA0</b>	1	1 unit
		O.M.R. 73033, yellow	II (right)	2	B	<b>3SU1050-4JP31-0AA0</b>	1	1 unit
		CES, SSG10	O	2	B	<b>3SU1050-5BP01-0AA0</b>	1	1 unit
			II (right)	2	B	<b>3SU1050-5BP31-0AA0</b>	1	1 unit
	O+II (center, right)		2	▶	<b>3SU1050-5BP61-0AA0</b>	1	1 unit	
	BKS, S1	O	2	B	<b>3SU1050-5PP01-0AA0</b>	1	1 unit	
	<p>Latching/momentary contact, 2x45° (10:30/12/1:30 o'clock), reset from right, latching to the left</p> 	RONIS, SB30	O	2	B	<b>3SU1050-4BN01-0AA0</b>	1	1 unit
			I	2	B	<b>3SU1050-4BN21-0AA0</b>	1	1 unit
			O+I (center, left)	2	B	<b>3SU1050-4BN51-0AA0</b>	1	1 unit
		CES, SSG10	O	2	B	<b>3SU1050-5BN01-0AA0</b>	1	1 unit
I			2	B	<b>3SU1050-5BN21-0AA0</b>	1	1 unit	
O+I (center, left)			2	▶	<b>3SU1050-5BN51-0AA0</b>	1	1 unit	
CES, STGH10		O+I	2	▶	<b>3SU1050-5LN51-0AA0</b>	1	1 unit	
BKS, S1		O	2	B	<b>3SU1050-5PN01-0AA0</b>	1	1 unit	
		I	2	B	<b>3SU1050-5PN21-0AA0</b>	1	1 unit	
		O+I (center, left)	2	B	<b>3SU1050-5PN51-0AA0</b>	1	1 unit	

#### Selection and ordering data

Version of actuating element	Color	DT	Order No.	PU (UNIT, SET, M)	PS*
<b>Indicator lights</b>					
 <p>3SU1051-6AA40-0AA0</p> <p><b>Indicator lights</b> with smooth lens</p>	Amber	B	<b>3SU1051-6AA00-0AA0</b>	1	1 unit
	Red	A	<b>3SU1051-6AA20-0AA0</b>	1	1 unit
	Yellow	A	<b>3SU1051-6AA30-0AA0</b>	1	1 unit
	Green	▶	<b>3SU1051-6AA40-0AA0</b>	1	1 unit
	Blue	B	<b>3SU1051-6AA50-0AA0</b>	1	1 unit
	White	A	<b>3SU1051-6AA60-0AA0</b>	1	1 unit
	Clear	B	<b>3SU1051-6AA70-0AA0</b>	1	1 unit

• Revised •  
08/31/15

# Push Button Units and Indicator Lights

## 3SU1 30 mm, Round, Metal, Matte — Actuating & Signaling Elements

Pushbuttons

1  
2  
3  
4  
5  
6  
7  
8  
9  
10

### Overview



- ① Actuator
- ② Adapter

Actuators and indicators, flat, 30mm, metal, matte  
(all devices are shipped including adapter)

### Selection and ordering data

Version	Operating principle	Unlatching method	Color	DT	Order No.	PU (UNIT, SET, M)	PS*
<b>Pushbuttons</b>							
 3SU1060-0JB50-0AA0	Pushbuttons with flat button	Momentary contact	Black	B	3SU1060-0JB10-0AA0	1	1 unit
			Red	B	3SU1060-0JB20-0AA0	1	1 unit
			Yellow	B	3SU1060-0JB30-0AA0	1	1 unit
			Green	B	3SU1060-0JB40-0AA0	1	1 unit
			Blue	B	3SU1060-0JB50-0AA0	1	1 unit
			White	B	3SU1060-0JB60-0AA0	1	1 unit
 3SU1060-0JA20-0AA0	Latching	Push to unlatch	Black	B	3SU1060-0JA10-0AA0	1	1 unit
			Red	B	3SU1060-0JA20-0AA0	1	1 unit
			Yellow	B	3SU1060-0JA30-0AA0	1	1 unit
			Green	B	3SU1060-0JA40-0AA0	1	1 unit
			Blue	B	3SU1060-0JA50-0AA0	1	1 unit
			White	B	3SU1060-0JA60-0AA0	1	1 unit
 3SU1061-0JB40-0AA0	Illuminated pushbuttons with flat button	Momentary contact	Red	B	3SU1061-0JB20-0AA0	1	1 unit
			Yellow	B	3SU1061-0JB30-0AA0	1	1 unit
			Green	B	3SU1061-0JB40-0AA0	1	1 unit
			Blue	B	3SU1061-0JB50-0AA0	1	1 unit
			Clear	B	3SU1061-0JB70-0AA0	1	1 unit
 3SU1061-0JA30-0AA0	Latching	Push to unlatch	Red	B	3SU1061-0JA20-0AA0	1	1 unit
			Yellow	B	3SU1061-0JA30-0AA0	1	1 unit
			Green	B	3SU1061-0JA40-0AA0	1	1 unit
			Blue	B	3SU1061-0JA50-0AA0	1	1 unit
			Clear	B	3SU1061-0JA70-0AA0	1	1 unit











# Push Button Units and Indicator Lights

## 3SU1 30 mm, Round, Metal, Matte — Actuating & Signaling Elements

• Revised •  
07/15/16

### Selector switches

#### Selection and ordering data

Version	Operating principle	Color	DT	Article No.	Price per PU	PU (UNIT, SET, M)	PS*	
<b>Selector switches</b>								
<b>2 switch positions, can be illuminated</b>								
 <p>3SU1062-2DC40-0AA0</p>	Selector, short black actuator and front ring for flat mounting	Momentary contact, 45° (10:30/12 o'clock), reset from center to left	Black	B	3SU1062-2DC10-0AA0	1	1 unit	
				Red	B	3SU1062-2DC20-0AA0	1	1 unit
				Green	B	3SU1062-2DC40-0AA0	1	1 unit
				White	B	3SU1062-2DC60-0AA0	1	1 unit
 <p>3SU1062-2DF10-0AA0</p>	Selector, long black actuator and front ring for flat mounting	Latching, 90° (10:30/1:30 o'clock)	Black	B	3SU1062-2DF10-0AA0	1	1 unit	
				Red	B	3SU1062-2DF20-0AA0	1	1 unit
				Green	B	3SU1062-2DF40-0AA0	1	1 unit
				Blue	B	3SU1062-2DF50-0AA0	1	1 unit
				White	B	3SU1062-2DF60-0AA0	1	1 unit
 <p>3SU1062-2EC20-0AA0</p>	Selector, long black actuator and front ring for flat mounting	Momentary contact, 45° (10:30/12 o'clock), reset from center to left	Black	B	3SU1062-2EC10-0AA0	1	1 unit	
				Red	B	3SU1062-2EC20-0AA0	1	1 unit
				Green	B	3SU1062-2EC40-0AA0	1	1 unit
				White	B	3SU1062-2EC60-0AA0	1	1 unit
 <p>3SU1062-2EF10-0AA0</p>	Selector, long black actuator and front ring for flat mounting	Latching, 90° (10:30/1:30 o'clock)	Black	B	3SU1062-2EF10-0AA0	1	1 unit	
				Red	B	3SU1062-2EF20-0AA0	1	1 unit
				Green	B	3SU1062-2EF40-0AA0	1	1 unit
				White	B	3SU1062-2EF60-0AA0	1	1 unit
<b>3 switch positions (I+O+II), can be illuminated</b>								
 <p>3SU1062-2DM60-0AA0</p>	Selector, short black actuator and front ring for flat mounting	Momentary contact, 2x45° (10:30/12/1:30 o'clock), reset from right + left	Black	B	3SU1062-2DM10-0AA0	1	1 unit	
				Red	B	3SU1062-2DM20-0AA0	1	1 unit
				Green	B	3SU1062-2DM40-0AA0	1	1 unit
				White	B	3SU1062-2DM60-0AA0	1	1 unit
 <p>3SU1062-2DL60-0AA0</p>	Selector, long black actuator and front ring for flat mounting	Latching, 2x45° (10:30/12/1:30 o'clock)	Black	B	3SU1062-2DL10-0AA0	1	1 unit	
				Red	B	3SU1062-2DL20-0AA0	1	1 unit
				Blue	B	3SU1062-2DL30-0AA0	1	1 unit
				Green	B	3SU1062-2DL40-0AA0	1	1 unit
				White	B	3SU1062-2DL60-0AA0	1	1 unit
 <p>3SU1062-2EM20-0AA0</p>	Selector, long black actuator and front ring for flat mounting	Momentary contact, 2x45° (10:30/12/1:30 o'clock), reset from right + left	Black	B	3SU1062-2EM10-0AA0	1	1 unit	
				Red	B	3SU1062-2EM20-0AA0	1	1 unit
				Green	B	3SU1062-2EM40-0AA0	1	1 unit
				White	B	3SU1062-2EM60-0AA0	1	1 unit
 <p>3SU1062-2EL20-0AA0</p>	Selector, long black actuator and front ring for flat mounting	Latching, 2x45° (10:30/12/1:30 o'clock)	Black	B	3SU1062-2EL10-0AA0	1	1 unit	
				Red	B	3SU1062-2EL20-0AA0	1	1 unit
				Green	B	3SU1062-2EL40-0AA0	1	1 unit
				White	B	3SU1062-2EL60-0AA0	1	1 unit



• Revised •  
07/15/16

# Push Button Units and Indicator Lights

## 3SU1 30 mm, Round, Metal, Matte — Actuating & Signaling Elements

### Key-operated switches / Indicator lights

1  
2  
3  
4  
5  
6  
7  
8  
9  
10

#### Selection and ordering data

Make of lock	Operating principle	Switch position for key removal	DT	Order No.	PU (UNIT, SET, M)	PS*
--------------	---------------------	---------------------------------	----	-----------	-------------------	-----

#### Key-operated switches with 2 keys

##### 2 switch positions (O+I)



3SU1060-4LF11-0AA0

RONIS, SB30 and front ring for flat mounting

Momentary contact, 45° (10:30/12 o'clock), reset from center to left



O

B

3SU1060-4LC01-0AA0

1

1 unit

Latching, 90° (10:30/1:30 o'clock)



O+I

B

3SU1060-4LF11-0AA0

1

1 unit

I

B

3SU1060-4LF21-0AA0

1

1 unit

##### 3 switch positions (I+O+II)



3SU1060-4LL11-0AA0

RONIS, SB30 and front ring for flat mounting

Latching, 2x45° (10:30/12/1:30 o'clock)



O+I+II

B

3SU1060-4LL11-0AA0

1

1 unit

#### Selection and ordering data

Version	Operating principle	Color	DT	Order No.	PU (UNIT, SET, M)	PS*
---------	---------------------	-------	----	-----------	-------------------	-----

#### Indicator lights



3SU1061-0JD40-0AA0

**Illuminated pushbuttons** Fixed button with flat button

Red  
Yellow  
Green  
Blue  
Clear

B  
B  
B  
B  
B

3SU1061-0JD20-0AA0  
3SU1061-0JD30-0AA0  
3SU1061-0JD40-0AA0  
3SU1061-0JD50-0AA0  
3SU1061-0JD70-0AA0

1  
1  
1  
1  
1

1 unit  
1 unit  
1 unit  
1 unit  
1 unit

### Special locks

#### Options

##### Special locks for key-operated switches

The plastic and metal key-operated switches of type RONIS, BKS, CES and IKON can be optionally ordered with additional locks.

In this case "-Z", the order code "Y01" and the required lock number must be added to the Order No. of the relevant key-operated switch for standard locking.

Order code	Y01
Normal delivery time	25 working days
Additional price per unit	On request
Ordering example	3SU1000-5BF01-0AA0-Z Y01 Z = SSG18

##### Ordering notes

- For all special locks, an additional price applies.
- The order code "Y01" must be quoted in accordance with the above tables. Automated processing of the order with a defined delivery time can be guaranteed only for correctly submitted orders.
- For applications in which access security is important and several lock numbers are used, we recommend the use of BKS or CES key-operated switches.
- Special locks for VW (E1, E2, ...) will be delivered without keys, all others with 2 keys.
- With RONIS, the special locks SB31, 421 and 455 are possible.

##### Master and master-pass key systems

The following key systems can be supplied with BKS, CES or IKON key-operated switches:

- Central lock systems
- Master key systems
- Central master key systems
- Master-pass key systems

When placing an order you must supplement the Order No. of the matching key-operated switches with "-Z" and quote the order code "Y03".

Price and delivery time on request.

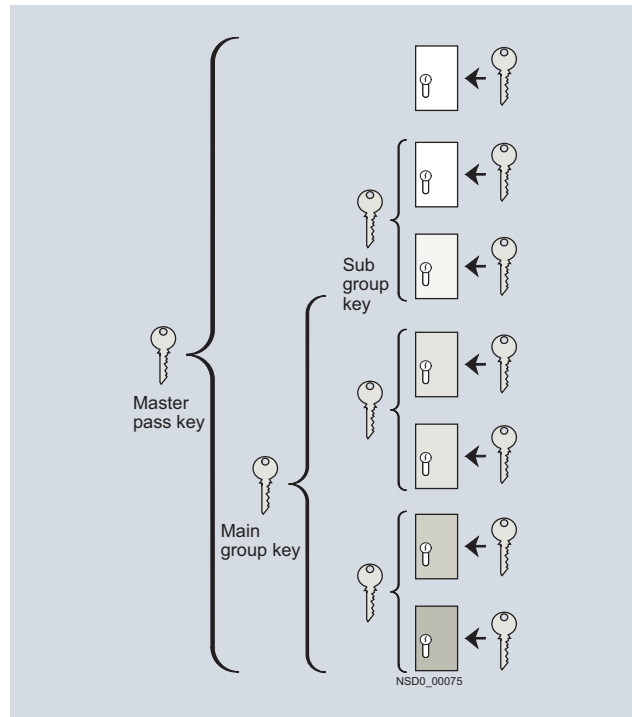

Example of master-pass key system

• Revised •  
08/31/15

# Push Button Units and Indicator Lights

## Actuators and Indicators, Customized Designs

Contact Block Selection Table for Selector Switches, Key-operated Switches, and 3-position push-pull

1  
2  
3  
4  
5  
6  
7  
8  
9  
10

### Selection and Ordering Data

Switch Position (front of switch)		Contact Block Circuit	Contact Block Position <sup>1)</sup>		Contact Block Order No.
Left	Right				

#### Two-Position Selector Switch Contact Block Selection

Switch Position (front of switch)		Contact Block Circuit	Contact Block Position <sup>1)</sup>		Contact Block Order No.
Left	Right				
○	X	1 NO	Any Position		<b>3SU1400-1AA10-1BA0</b>
X	○	1 NC	Any Position		<b>3SU1400-1AA10-1CA0</b>
○	X ○	1 NO/1 NC	Any Position		<b>3SU1400-1AA10-1FA0</b>
○	X X	2 NO	Any Position		<b>3SU1400-1AA10-1DA0</b>
X	○ ○	2 NC	Any Position		<b>3SU1400-1AA10-1EA0</b>

Switch Position (front of switch)			Contact Block Circuit	Contact Block Position <sup>1)</sup>		Contact Block Order No.
Left	Center	Right		On Holder	Stacked	

#### Three-Position Selector Switch Contact Block Selection

Switch Position (front of switch)			Contact Block Circuit	Contact Block Position <sup>1)</sup>		Contact Block Order No.
Left	Center	Right		On Holder	Stacked	
X	○	○	1 NO	2 or 3A	5 or 6A	<b>3SU1400-1AA10-1BA0</b>
X	○	X	1 NO	3	6	<b>3SU1400-1AA10-1BA0</b>
○	○	X	1 NO	1 or 3B	4 or 6B	<b>3SU1400-1AA10-1BA0</b>
○	X	X	1 NC	2 or 3A	5 or 6A	<b>3SU1400-1AA10-1CA0</b>
○	X	○	1 NC	3	6	<b>3SU1400-1AA10-1CA0</b>
X	X	○	1 NC	1 or 3B	4 or 6B	<b>3SU1400-1AA10-1CA0</b>
X	○	○	1 NO/1 NC	2 or 3A	--	<b>3SU1400-1AA10-1FA0</b>
○	X	X	1 NO/1 NC	3	--	<b>3SU1400-1AA10-1FA0</b>
○	○	X	1 NO/1 NC	1 or 3B	--	<b>3SU1400-1AA10-1FA0</b>
X	○	○	2 NO	2 or 3A	--	<b>3SU1400-1AA10-1DA0</b>
X	○	X	2 NO	3	--	<b>3SU1400-1AA10-1DA0</b>
○	○	X	2 NO	1 or 3B	--	<b>3SU1400-1AA10-1DA0</b>
○	X	X	2 NC	2 or 3A	--	<b>3SU1400-1AA10-1EA0</b>
○	X	○	2 NC	3	--	<b>3SU1400-1AA10-1EA0</b>
X	X	○	2 NC	1 or 3B	--	<b>3SU1400-1AA10-1EA0</b>

#### Three-Position Push-Pull Contact Block Selection

Out	Center	In	Contact Block Circuit	Contact Block Position <sup>1)</sup>		Contact Block Order No.
				On Holder	Stacked	
X	○	○	1 NO	2 or 3A	5 or 6A	<b>3SU1400-1AA10-1BA0</b>
○	○	X	1 NO	1 or 3B	4 or 6B	<b>3SU1400-1AA10-1BA0</b>
X	X	○	1 NC	1 or 3B	4 or 6B	<b>3SU1400-1AA10-1CA0</b>
○	X	X	1 NC	2 or 3A	5 or 6A	<b>3SU1400-1AA10-1CA0</b>
○	X ○	X ○	1 NO/1 NC	2 or 3A	--	<b>3SU1400-1AA10-1FA0</b>
X	X ○	○ X	1 NO/1 NC	1 or 3B	--	<b>3SU1400-1AA10-1FA0</b>
○	X ○	○ X	2 NC	3	--	<b>3SU1400-1AA10-1FA0</b>

<sup>1)</sup> Single-element Contact Blocks are stackable (2 deep). Dual Contact Blocks are not stackable.

In order to attach a Light Module to the actuator, both plungers must be removed and Light Module placed in position #3.

Rear View	Plungers Inserted	Center Module Position Numbers	Replace the asterisks in center position numbers 3* or 6*:
	Both	3 or 6	Contact Blocks Position Number will be (3 or 6) when "Both" plungers are installed.
	Right	3B or 6B	Contact Blocks Position Number will be (3B or 6B) when "Right" plunger only is installed.
	Left	3A or 6A	Contact Blocks Position Number will be (3A or 6A) when "Left" plunger only is installed.
	None	None	Both plungers are removed if Center Module Position 3 is used with LED Light Module

X ----- Contact Closed  
○ ----- Contact Open  
3 or 6 ----- Both Plungers Inserted  
3A or 6A --- Left Plunger Inserted  
3B or 6B --- Right Plunger Inserted

# Push Button Units and Indicator Lights

## Actuators and Indicators, Customized Designs

• Revised •  
08/31/15

### Contact Block Selection Table for Selector Switches and Key-operated Switches

#### Function Table

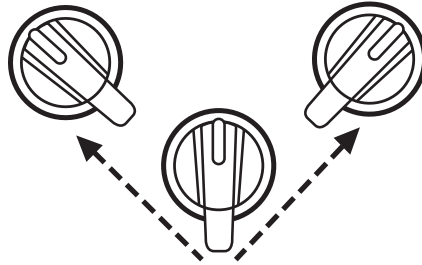

Plunger Position		Selector Switch Position <sup>1)</sup>					
Rear View	Front View	Left Position			Right Position		
		2	3	1	2	3	1
		■	■	□	□	■	■
		■	□	□	□	■	■
		■	■	□	□	□	■
		■	⊗	□	□	⊗	■

- Activated
- Not Activated
- ⊗ LED Available
- Plunger

<sup>1)</sup> The selector switch position is viewed from the front.

All selector switches are packaged with two plungers, which can be removed manually.

### Options

#### Inscription of actuating and signaling elements

Actuating and signaling elements of plastic as well as metal version can be optionally inscribed with a laser.



Example of laser inscription

The actuators of the flat and raised pushbuttons, illuminated pushbuttons, twin pushbuttons, mushroom pushbuttons, illuminated mushroom pushbuttons, EMERGENCY STOP buttons, the lenses of the indicator lights, and the acoustic signaling devices can all be inscribed.

Selector switches, key-operated switches, toggle switches, coordinate switches, potentiometers and selectors can be inscribed only if they are made of plastic (only one text line on the front ring).

#### Version

A letter height of 4 mm is used as standard for text inscriptions.

The typeface used is Arial. Other letter heights and typefaces are possible, but must be specified when ordering.

The maximum possible number of characters per line is:

- 10 characters for one line of text
- 8 characters for 2 lines of text
- 6 characters for 3 lines of text, but 10 characters in the middle line.

#### Note:

Selected pushbuttons and twin pushbuttons can be supplied as standard with inscribed letters or symbols.

#### Ordering notes

To order, the inscribed actuating and signaling elements can be selected via the SIRIUS ACT Configurator. An electronic order form is then generated.

Configurator see

- [www.siemens.com/sirius-act/configurator](http://www.siemens.com/sirius-act/configurator)
- Electronic Catalog CA 01 on DVD or
- Industry Mall: [www.usa.siemens.com/industrymall](http://www.usa.siemens.com/industrymall)

When ordering, supplement the Order No. of the actuating element or the indicator light with **"-Z"** and an order code:

- Text line in upper/lower case, always upper case for beginning of line (e.g. "Lift / Off"): **Y10**
- Text in upper case (e.g. "LIFT"): **Y11**
- Text in lower case (e.g. "lift / off / lower"): **Y12**
- Text in upper/lower case, all words begin with upper case letters (e.g. "On Off"): **Y15**
- Symbol with number according to ISO 7000 or IEC 60417: **Y13**
- Any inscription or symbol according to order form supplement: **Y19**

When ordering, specify the required inscription in plain text in addition to the Order No. and order code. In the case of special inscriptions with words in languages other than German, give the exact spelling and specify the language. In the case of symbols with number, quote the corresponding standard (see ordering example 1).

In the case of multi-line inscriptions, the text must be assigned to the respective line, e.g. "Z1 = Lift, Z2 = Lower". For long words you can also specify the end-of-line division.

Symbols can also be ordered with numbers according to ISO 7000 or IEC 60417 (see ordering examples 2 and 3).

The SIRIUS ACT Configurator must be used to select special inscriptions and symbols (order code Y19). In this case a "CIN" (Configuration Identification Number) is generated for placement of future orders. It is then possible to place an order directly using the CIN and the SIRIUS ACT Configurator (Mall shopping cart) or via the standard order channels.

#### Ordering example 1

A round pushbutton with the inscription "Reset" is required:

3SU1030-0AA40-0AA0-Z  
Y10  
Z = Reset (English)

#### Ordering example 2

A flat pushbutton inscribed with symbol No. 5389 according to IEC 60417 is required:

3SU1900-0FT10-0AA0  
Y13  
Z = 5389 IEC

#### Ordering example 3

A round pushbutton inscribed with symbol No. 1118 according to ISO 7000 is required:

3SU1030-0AB20-0AA0-Z  
Y13  
Z = 1118 ISO

### Holders without module

#### Overview

Holders made of plastic can only be attached to actuators and indicators made of plastic (3SU100) or plastic with metal front ring (3SU103).

Metal holders can be attached to all versions of actuators and indicators. Metal holders are automatically grounded by their fastening screw, but a grounding stud can also be fitted.

#### Selection and ordering data

	Version	Holder material	DT	Order No.	PU (UNIT, SET, M)	PS*
<b>Holders without module</b>						
	<b>3x without module</b>	Plastic	A	<b>3SU1500-0AA10-0AA0</b>	1	1 unit
3SU1500-0AA10-0AA0						
	<b>4x without module</b> For selector switch with 4 switch positions and for coordinate switches	Plastic	A	<b>3SU1500-0BA10-0AA0</b>	1	1 unit
3SU1500-0BA10-0AA0						
<b>Holders without module</b>						
	Version	Holder material	DT	Order No.	PU (UNIT, SET, M)	PS*
	<b>3x without module</b>	Metal	A	<b>3SU1550-0AA10-0AA0</b>	1	1 unit
3SU1550-0AA10-0AA0						
	<b>4x without module</b> For selector switch with 4 switch positions and for coordinate switches	Metal	A	<b>3SU1550-0BA10-0AA0</b>	1	1 unit
3SU1550-0BA10-0AA0						

• Revised •  
07/15/16

# Push Button Units and Indicator Lights

## Holders

### 1 Holders with module

1  
2  
3  
4  
5  
6  
7  
8  
9  
10

#### Selection and ordering data

Number of Contact modules	LED modules	NO contacts	NC contacts	Color of light source	DT	Screw terminals		PU (UNIT, SET, M)	PS*	PG
						Article No.	Price per PU			

#### 1 Holders with module



3SU1500-1AA10-1BA0

3x with module, plastic										
1	0	1	0	--	B	3SU1500-1AA10-1BA0		1	1 unit	41J
		0	1		B	3SU1500-1AA10-1CA0		1	1 unit	41J
2	0	2	0	--	B	3SU1500-1AA10-1NA0		1	1 unit	41J
2	0	0	2		B	3SU1500-1AA10-1PA0		1	1 unit	41J



3SU1501-1AG20-1CA0

3x with contact and LED module <sup>1)</sup> (6 ... 24 V AC/DC)										
1	1	1	0	Amber	B	3SU1501-1AG00-1BA0		1	1 unit	41J
				Red	B	3SU1501-1AG20-1BA0		1	1 unit	41J
				Yellow	B	3SU1501-1AG30-1BA0		1	1 unit	41J
				Green	B	3SU1501-1AG40-1BA0		1	1 unit	41J
				Blue	B	3SU1501-1AG50-1BA0		1	1 unit	41J
				White	B	3SU1501-1AG60-1BA0		1	1 unit	41J



3SU1501-1AG20-1LA0

0	1		1	Amber	⊖	B	3SU1501-1AG00-1CA0		1	1 unit	41J
				Red	⊖	B	3SU1501-1AG20-1CA0		1	1 unit	41J
				Yellow	⊖	B	3SU1501-1AG30-1CA0		1	1 unit	41J
				Green	⊖	B	3SU1501-1AG40-1CA0		1	1 unit	41J
				Blue	⊖	B	3SU1501-1AG50-1CA0		1	1 unit	41J
				White	⊖	B	3SU1501-1AG60-1CA0		1	1 unit	41J

2	1	0	1	Amber	⊖	B	3SU1501-1AG00-1NA0		1	1 unit	41J
				Red	⊖	B	3SU1501-1AG20-1NA0		1	1 unit	41J
				Yellow	⊖	B	3SU1501-1AG30-1NA0		1	1 unit	41J
				Green	⊖	B	3SU1501-1AG40-1NA0		1	1 unit	41J
				Blue	⊖	B	3SU1501-1AG50-1NA0		1	1 unit	41J
				White	⊖	B	3SU1501-1AG60-1NA0		1	1 unit	41J

<sup>1)</sup> Only for use with SIRIUS commanding and signaling devices.

Number of Contact modules	NO contacts	NC contacts	DT	Screw terminals		PU (UNIT, SET, M)	PS*	PG
				Article No.	Price per PU			

#### 1 Holders with module



3SU1550-1AA10-1BA0

3x with module, metal											
1	1	0			B	3SU1550-1AA10-1BA0		1	1 unit	41J	
					⊖	B	3SU1550-1AA10-1CA0		1	1 unit	41J
2	2	0			⊖	B	3SU1550-1AA10-1NA0		1	1 unit	41J
					⊖	B	3SU1550-1AA10-1PA0		1	1 unit	41J

⊖ Positive opening according to IEC 60947-5-1, Annex K.  
Can be used with 3SK11 safety relays or the 3RK3 Modular Safety System;  
see page 11/1 onwards.  
Certificate:



# Push Button Units and Indicator Lights

## Modules for Actuators and Indicators

• Revised •  
07/15/16

### Contact modules

#### Overview

##### Contact modules and LED modules

The contact modules are fitted with slow-action contacts (NO contacts or NC contacts). These ensure a high switching reliability even with small voltages and currents, such as 5 V/1 mA. They are suitable for use in electronic systems as well as conventional controls. The contact pieces of the NC contacts are positively driven.

Only LED modules with permanently integrated LEDs are available for illumination.

Contact modules and LED modules bear terminal designations acc. to EN 50013

##### Mounting the modules







With SIRIUS ACT, the modules are mounted on the holder without any further accessories. Holders in plastic or metal versions are available for mounting three modules.

##### Connection methods

The modules are available with:

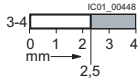
- Screw terminals
- Spring-type terminals or
- Solder pin connection (0.8 mm × 0.8 mm solder pins) for assembly on printed circuit boards

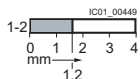
#### Selection and ordering data

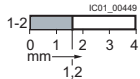
Contact version	Number of		DT	Screw terminals	PU (UNIT, SET, M)	PS*		
	NO contacts	NC contacts						
<b>Contact modules for front plate mounting</b>								
	Silver alloy	1	0			▶ <b>3SU1400-1AA10-1BA0</b>	1	1 unit
		0	1			▶ <b>3SU1400-1AA10-1CA0</b>	1	1 unit
		0	1 with installation monitoring <sup>1)</sup>			▶ <b>3SU1400-1AA10-1HA0</b>	1	1 unit

<sup>1)</sup> The contact module has 1 NO internal contact + 1 NC internal contact. The NO contact is connected in series with the NC contact and brought out at terminal 1-2. When the module is snapped onto the holder, the NO contact closes. It opens when the module is detached from the holder again (the NC contact remains closed). The NC contact opens when the EMERGENCY STOP device is actuated (the NO contact remains closed). The contact is closed only when both the NC and NO contacts are closed. Unsuitable for mounting in 3SU18 enclosure.

⊕ Positive opening according to IEC 60947-5-1, Annex K. Can be used with 3SK11 safety relays or the 3RK3 Modular Safety System; see page 11/1 onwards. Certificate:









• Revised •  
07/15/16

# Push Button Units and Indicator Lights

## Modules for Actuators and Indicators

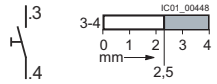
### Contact modules

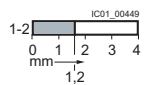
1  
2  
3  
4  
5  
6  
7  
8  
9  
10

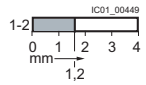
Contact version	Number of		DT	Spring-type terminals	PU (UNIT, SET, M)	PS*	
	NO contacts	NC contacts					
<b>Contact modules for front plate mounting</b>							
 3SU1400-1AA10-3BA0	Silver alloy	1	0			1	1 unit
		0	1			1	1 unit
 3SU1400-1AA10-3HA0		0	1 with installation monitoring <sup>1)</sup>			1	1 unit

<sup>1)</sup> The contact module has 1 NO internal contact + 1 NC internal contact. The NO contact is connected in series with the NC contact and brought out at terminal 1-2. When the module is snapped onto the holder, the NO contact closes. It opens when the module is detached from the holder again (the NC contact remains closed). The NC contact opens when the EMERGENCY STOP device is actuated (the NO contact remains closed). The contact is closed only when both the NC and NO contacts are closed. Unsuitable for mounting in 3SU18 enclosure.

⊕ Positive opening according to IEC 60947-5-1, Annex K.  
Can be used with 3SK11 safety relays or the 3RK3 Modular Safety System; see page 11/1 onwards.  
Certificate:





# Push Button Units and Indicator Lights Modules for Actuators and Indicators

• Revised •  
08/31/15

## LED modules

### Selection and ordering data

	Operational voltage at AC	Operational voltage at DC	Color	DT	Screw terminals	PU (UNIT, SET, M)	PS*
	V	V			Order No.		
<b>LED modules<sup>1)</sup> for front plate mounting</b>							
 3SU1401-1BB30-1AA0	24	24	Amber	A	3SU1401-1BB00-1AA0	1	1 unit
			Red ▶		3SU1401-1BB20-1AA0		
			Yellow ▶		3SU1401-1BB30-1AA0		
			Green ▶		3SU1401-1BB40-1AA0		
			Blue ▶		3SU1401-1BB50-1AA0		
			White ▶		3SU1401-1BB60-1AA0		
			110	--	Amber		
Red ▶		3SU1401-1BC20-1AA0					
Yellow ▶		3SU1401-1BC30-1AA0					
Green ▶		3SU1401-1BC40-1AA0					
Blue ▶		3SU1401-1BC50-1AA0					
White ▶		3SU1401-1BC60-1AA0					
230	--	Amber	B	3SU1401-1BF00-1AA0	1	1 unit	
		Red ▶		3SU1401-1BF20-1AA0			
		Yellow ▶		3SU1401-1BF30-1AA0			
		Green ▶		3SU1401-1BF40-1AA0			
		Blue ▶		3SU1401-1BF50-1AA0			
		White ▶		3SU1401-1BF60-1AA0			
<b>Spring-type terminals</b>							
 3SU1401-1BB30-3AA0	24	24	Amber	B	3SU1401-1BB00-3AA0	1	1 unit
			Red ▶		3SU1401-1BB20-3AA0		
			Yellow ▶		3SU1401-1BB30-3AA0		
			Green ▶		3SU1401-1BB40-3AA0		
			Blue ▶		3SU1401-1BB50-3AA0		
			White ▶		3SU1401-1BB60-3AA0		
			110	--	Amber		
Red ▶		3SU1401-1BC20-3AA0					
Yellow ▶	B	3SU1401-1BC30-3AA0					
Green ▶		3SU1401-1BC40-3AA0					
Blue ▶	B	3SU1401-1BC50-3AA0					
White ▶		3SU1401-1BC60-3AA0					
230	--	Amber	B	3SU1401-1BF00-3AA0	1	1 unit	
		Red ▶		3SU1401-1BF20-3AA0			
		Yellow ▶	B	3SU1401-1BF30-3AA0			
		Green ▶		3SU1401-1BF40-3AA0			
		Blue ▶	B	3SU1401-1BF50-3AA0			
		White ▶		3SU1401-1BF60-3AA0			

<sup>1)</sup> Only for use with SIRIUS commanding and signaling devices.

• Revised •  
07/15/16

# Push Button Units and Indicator Lights

## Modules for Actuators and Indicators

### LED modules

1  
2  
3  
4  
5  
6  
7  
8  
9  
10



3SU1401-1BG30-1AA0



3SU1401-1BG30-3AA0

Operational voltage at AC	Operational voltage at DC	Color	DT	Screw terminals	PU (UNIT, SET, M)	PS*
V	V			Order No.		
<b>LED modules<sup>1)</sup> for front plate mounting</b>						
6 ... 24	6 ... 24	Amber Red Yellow Green Blue White	A	3SU1401-1BG00-1AA0 3SU1401-1BG20-1AA0 3SU1401-1BG30-1AA0 3SU1401-1BG40-1AA0 3SU1401-1BG50-1AA0 3SU1401-1BG60-1AA0	1	1 unit
24 ... 240	24 ... 240	Amber Red Yellow Green Blue White	B	3SU1401-1BH00-1AA0 3SU1401-1BH20-1AA0 3SU1401-1BH30-1AA0 3SU1401-1BH40-1AA0 3SU1401-1BH50-1AA0 3SU1401-1BH60-1AA0	1	1 unit
<b>Spring-type terminals</b>						
6 ... 24	6 ... 24	Amber Red Yellow Green Blue White	B	3SU1401-1BG00-3AA0 3SU1401-1BG20-3AA0 3SU1401-1BG30-3AA0 3SU1401-1BG40-3AA0 3SU1401-1BG50-3AA0 3SU1401-1BG60-3AA0	1	1 unit
24 ... 240	24 ... 240	Amber Red Yellow Green Blue White	B	3SU1401-1BH00-3AA0 3SU1401-1BH20-3AA0 3SU1401-1BH30-3AA0 3SU1401-1BH40-3AA0 3SU1401-1BH50-3AA0 3SU1401-1BH60-3AA0	1	1 unit

<sup>1)</sup> Only for use with SIRIUS commanding and signaling devices.



3SU1400-1CK10-1AA0

Operational voltage at AC	Operational voltage at DC	DT	Screw terminals	PU (UNIT, SET, M)	PS*
V	V		Order No.		
<b>LED test modules<sup>1)</sup> for front plate mounting</b>					
12 ... 240	12 ... 240		3SU1400-1CK10-1AA0	1	1 unit

Operational voltage at AC	Operational voltage at DC	Color	DT	Socket terminals (THT)	PU (UNIT, SET, M)	PS*
V	V			Order No.		
<b>LED modules<sup>1)</sup> for mounting on printed circuit boards</b>						
--	5	Amber Red Yellow Green Blue White	B	3SU1401-3BA00-5AA0 3SU1401-3BA20-5AA0 3SU1401-3BA30-5AA0 3SU1401-3BA40-5AA0 3SU1401-3BA50-5AA0 3SU1401-3BA60-5AA0	1	1 unit

3SU1401-3BA20-5AA0

<sup>1)</sup> Only for use with SIRIUS commanding and signaling devices.

# Push Button Units and Indicator Lights Modules for Actuators and Indicators

• Revised •  
07/15/16

## AS-Interface modules

### Selection and ordering data

Operational voltage	Slave type	Number of digital inputs		Number of digital outputs	DT	Screw terminals + Spring-type terminals	PU (UNIT, SET, M)	PS*	
		Standard	Safety-related						
						Order No.			
<b>AS-Interface modules for front plate mounting</b>									
 3SU1400-1EA10-2AA0	30 V	2 F-DI	--	2	--	B	<b>3SU1400-1EA10-2AA0</b>	1	1 unit
	30 V	2 F-DI + 1 LED	--	2	--	B	<b>3SU1401-1EE20-2AA0</b>	1	1 unit
 3SU1400-1EC10-2AA0		2 F-DI + 1 DQ	--	2	1	B	<b>3SU1400-1EC10-2AA0</b>	1	1 unit
 3SU1400-1EA10-4AA0	30 V	2 F-DI	--	2	--	B	<b>3SU1400-1EA10-4AA0</b>	1	1 unit
		2 F-DI + 1 LED	--	2	--	B	<b>3SU1401-1EE20-4AA0</b>	1	1 unit
 3SU1400-1EC10-4AA0		2 F-DI + 1 DQ	--	2	1	B	<b>3SU1400-1EC10-4AA0</b>	1	1 unit
		4 DI + 3 DO	--	4	3	B	<b>3SU1400-1EJ10-6AA0</b>	1	1 unit
		4 DI + 4 DO	--	4	4	B	<b>3SU1400-1EK10-6AA0</b>	1	1 unit
<b>Electronic module for IO-Link, front panel mounting</b>									
 3SU1400-1HL10-6AA0	24 V	Freely programmable (default 6DI/2DQ)	0-8	--	0-8	B	<b>3SU1400-1HL10-6AA0</b>	1	1 unit

• Revised •  
08/31/15

# Push Button Units and Indicator Lights

## Modules for Actuators and Indicators



Electronic modules for ID key-operated switches

1  
2  
3  
4  
5  
6  
7  
8  
9  
10

### Technical specifications

Order No.	3SU1400-1GC10-1AA0	3SU1400-1GD10-1AA0
<b>Communication</b>		
Protocol is supported by IO-Link protocol	No	Yes
Product function	Group ID 24 V DC	IO-Link 24 V DC
IO-Link transfer rate	--	COM2 (38.4 kBaud)
Point-to-point cycle time between the master and the IO-Link device minimum	ms --	10
Type of voltage supply via IO-Link master	--	3
<b>Data volume</b>		
• of the address area of the inputs with cyclic transfer total	bytes --	2
• of the address area of the outputs with cyclic transfer total	bytes --	0
Number of NO contacts	5	5
<b>General data</b>		
Impulse withstand voltage rated value	V 800	
Insulation voltage rated value	V 30	
Pollution degree	3	
<b>Type of voltage</b>		
• of operational voltage	DC	
• of input voltage	DC	
<b>Operational voltage</b>		
• 1 at DC rated value	V 24	
• Rated value	V 18 ... 30	
Current consumed maximum	mA 49	
<b>Ambient temperature</b>		
• During operation	°C -25 ... +70	
• During storage	°C -40 ... +80	
IP degree of protection	IP20	
Touch protection against electric shock	Finger-safe	
<b>Connections</b>		
Type of electrical connection	Screw terminals 	
<b>Connectable conductor cross-section for auxiliary contacts</b>		
• Solid or stranded	mm <sup>2</sup> 0.2 ... 2.5	
• Solid		
- With end sleeves	mm <sup>2</sup> 0.2 ... 0.75	
• Finely stranded		
- With end sleeves	mm <sup>2</sup> 0.25 ... 1.5	
- Without end sleeves	mm <sup>2</sup> 0.2 ... 2.5	
<b>AWG number as coded connectable conductor cross-section</b>		
• For auxiliary contacts	26 ... 14	
<b>Tightening torque</b>		
• For screw terminals	Nm 0.4 ... 0.8	

### Selection and ordering data

	Type of voltage supply via IO-Link master	Protocol is supported IO-Link protocol	Number of NO contacts	IO-Link transfer rate	DT	Screw terminals 	PU (UNIT, SET, M)	PS*
	Order No.							
<b>Electronic modules for ID key-operated switches</b>								
	--	No	5	--	B	3SU1400-1GC10-1AA0	1	1 unit
3SU1400-1GC10-1AA0								
	Yes	Yes	5	COM2 (38.4 kBaud)	X	3SU1400-1GD10-1AA0	1	1 unit
3SU1400-1GD10-1AA0								
✓ Yes -- No								

## General data

### Overview

#### Design



Enclosures with standard fittings

Enclosed SIRIUS ACT pushbuttons and indicator lights are used as hand-operated commanding devices for separately allocated control units and cabinets. The devices are suitable for use in any climate.

#### Standards

IEC 60947-5-1 or EN 60947-5-1

#### Versions

The enclosed pushbuttons and indicator lights are available with conventional controls as well as for connection to AS-Interface. The following versions are available:

- Empty enclosures with 1 to 6 command points (the installed components must be ordered separately; use modules for base mounting)
- Enclosures with standard fittings with 1 to 3 command points, e.g. EMERGENCY STOP enclosure with EMERGENCY STOP mushroom pushbutton
- Enclosures with customized fittings with 1 to 6 command points

#### Color of the enclosures

Top:

- Gray, RAL 7035
- Yellow, RAL 1004 for EMERGENCY STOP

Base:

- Black, RAL 9005

#### Customized enclosures

The fittings and labeling of the command points can be chosen using the Configurator on the Internet, see: [www.siemens.com/sirius-act/configurator](http://www.siemens.com/sirius-act/configurator)

#### Enclosures with standard fittings

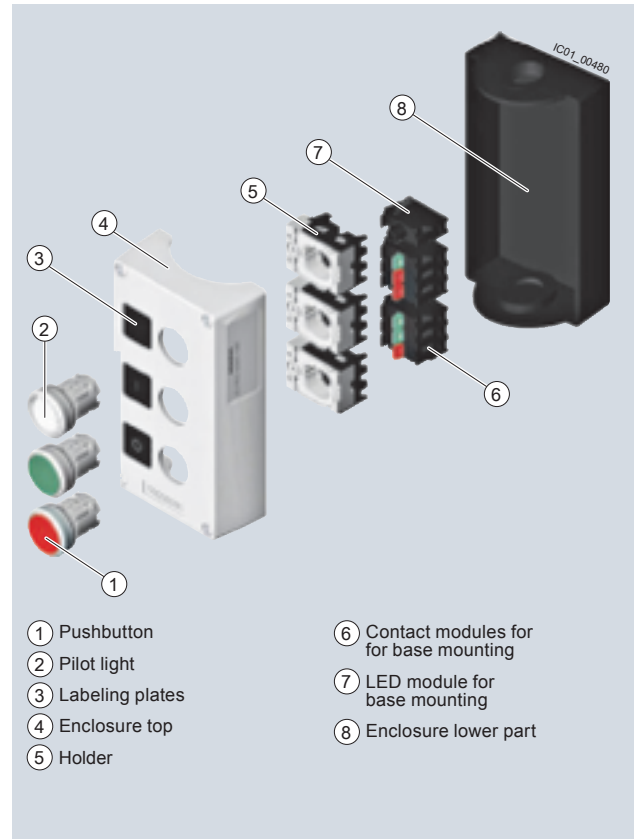

Pushbuttons and indicator lights in the enclosure

#### Nomenclature of command points

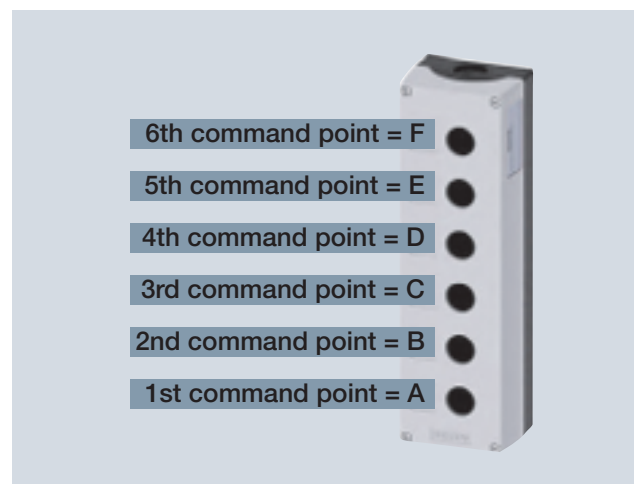

### Application

The enclosures are climate-proof (KTW 24) according to EN ISO 6270-2 and suitable for stationary use, and for use in marine applications.

• Revised •  
07/15/16

# Push Button Units and Indicator Lights Enclosures

Empty enclosures

1  
2  
3  
4  
5  
6  
7  
8  
9  
10

## Selection and ordering data

Color of enclosure top	Number of command points	Enclosure version	DT	Order No.	PU (UNIT, SET, M)	PS*
------------------------	--------------------------	-------------------	----	-----------	-------------------	-----

### Enclosures for surface mounting

#### Plastic version

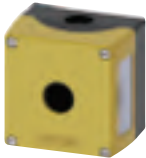

3SU1801-0AA00-0AA2

Yellow	1	Center command point	A	<b>3SU1801-0AA00-0AA2</b>	1	1 unit
		With protective collar	A	<b>3SU1801-0AA00-0AC2</b>	1	1 unit
		With recess for labeling plate	A	<b>3SU1801-0AA00-0AB2</b>	1	1 unit
	2	With recess for labeling plate	▶	<b>3SU1802-0AA00-0AB2</b>	1	1 unit



3SU1802-0AA00-0AB1

Gray	1	With recess for labeling plate	A	<b>3SU1801-0AA00-0AB1</b>	1	1 unit
	2	With recess for labeling plate	A	<b>3SU1802-0AA00-0AB1</b>	1	1 unit
	3	With recess for labeling plate	A	<b>3SU1803-0AA00-0AB1</b>	1	1 unit
	4	With recess for labeling plate	A	<b>3SU1804-0AA00-0AB1</b>	1	1 unit
	6	With recess for labeling plate	A	<b>3SU1806-0AA00-0AB1</b>	1	1 unit

#### Metal version

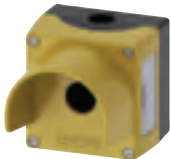

3SU1851-0AA00-0AC2

Yellow	1	Center command point	B	<b>3SU1851-0AA00-0AA2</b>	1	1 unit
		With protective collar	B	<b>3SU1851-0AA00-0AC2</b>	1	1 unit
		With recess for labeling plate	A	<b>3SU1851-0AA00-0AB2</b>	1	1 unit



3SU1853-0AA00-0AB1

Gray	1	With recess for labeling plate	▶	<b>3SU1851-0AA00-0AB1</b>	1	1 unit
		With protective collar	B	<b>3SU1851-0AA00-0AC1</b>	1	1 unit
	2	With recess for labeling plate	▶	<b>3SU1852-0AA00-0AB1</b>	1	1 unit
	3	With recess for labeling plate	▶	<b>3SU1853-0AA00-0AB1</b>	1	1 unit



3SU1854-0AA00-0AB1

	4	With recess for labeling plate	▶	<b>3SU1854-0AA00-0AB1</b>	1	1 unit
	6	With recess for labeling plate	B	<b>3SU1856-0AA00-0AB1</b>	1	1 unit

### Enclosure for 4-position selector and coordinate switch

#### Plastic version



3SU1801-1AA00-1AA1

Gray	1	Center command point	B	<b>3SU1801-1AA00-1AA1</b>	1	1 unit
------	---	----------------------	---	---------------------------	---	--------

#### Metal version

Gray	1	Center command point	B	<b>3SU1851-1AA00-1AA1</b>	1	1 unit
------	---	----------------------	---	---------------------------	---	--------

## Pushbuttons and indicator lights in the enclosure

### Overview

Pushbuttons and indicator lights in the enclosure (standard fittings) are available with:

- 1 to 3 command points
- Operating voltage up to 400 V
- Vertical mounting type
- Plastic enclosures are equipped with plastic actuators and indicators, metal enclosures are equipped with metal actuators and indicators
- Contact modules and LED modules for base mounting (are snapped into the enclosure base); screw terminals as standard; some versions also with spring-type terminals

### Selection and ordering data

Color enclosure top	Number of command points	Enclosure version Command point fittings	Color of actuating element Marking	Number of: NC contacts NO contacts	DT	Order No.	PU (UNIT, SET, M)	PS*
---------------------	--------------------------	---	---------------------------------------	--	----	-----------	-------------------	-----

#### Enclosures with standard fittings

##### Plastic version



3SU1801-0NA00-2AA2



3SU1801-0NA00-2AC2

Yellow	1	Center command point A = EMERGENCY STOP mushroom pushbutton, 40 mm, with positive latching function according to ISO 13850, Rotate to unlatch	Red	1 0	A	<b>3SU1801-0NA00-2AA2</b>	1	1 unit
		With protective collar A = EMERGENCY STOP mushroom pushbutton, 40 mm, with positive latching function according to ISO 13850, Rotate to unlatch	Red	1 0	A	<b>3SU1801-0NA00-2AC2</b>	1	1 unit
				2 0	A	<b>3SU1801-0NB00-2AC2</b>	1	1 unit
	2	With recess for labeling plate A = EMERGENCY STOP mushroom pushbutton, 40 mm, with positive latching function according to ISO 13850, Rotate to unlatch B = indicator light	A = red, without inscription B = red, without inscription	2 1	B	<b>3SU1802-0NB00-2AB2</b>	1	1 unit



• Revised •  
07/15/16

# Push Button Units and Indicator Lights

## Enclosures

### Pushbuttons and indicator lights in the enclosure

1  
2  
3  
4  
5  
6  
7  
8  
9  
10

Color enclosure top	Number of command points	Enclosure version Command point fittings	Color of actuating element Marking	Number of: NC contacts NO contacts	DT	Order No.	PU (UNIT, SET, M)	PS*
---------------------	--------------------------	---	---------------------------------------	--	----	-----------	----------------------	-----

#### Enclosures with standard fittings

##### Plastic version



3SU1801-0AB00-2AB1



3SU1802-0AB00-2AB1









3SU1803-0AB00-2AB1

Gray	1	With recess for labeling plate A = pushbutton	A = green, I	0	1	B	<b>3SU1801-0AB00-2AB1</b>	1	1 unit
			A = red, O	1	0	B	<b>3SU1801-0AC00-2AB1</b>	1	1 unit
			A = white, I	0	1	B	<b>3SU1801-0AD00-2AB1</b>	1	1 unit
			A = black, O	1	0	B	<b>3SU1801-0AE00-2AB1</b>	1	1 unit
2	With recess for labeling plate A = pushbutton / B = pushbutton	A = red, O B = green, I	1	1	B	<b>3SU1802-0AB00-2AB1</b>	1	1 unit	
		A = black, O B = black, I	1	1	B	<b>3SU1802-0AC00-2AB1</b>	1	1 unit	
3	With recess for labeling plate A = pushbutton / B = pushbutton / C = indicator light	A = red, O B = green, I C = clear, without inscription	1	1	B	<b>3SU1803-0AB00-2AB1</b>	1	1 unit	
		A = black, O B = white, I C = clear, without inscription	1	1	B	<b>3SU1803-0AC00-2AB1</b>	1	1 unit	
		With recess for labeling plate A = pushbutton / B = pushbutton / C = pushbutton	A = red, O B = black, I C = black, II	1	2	B	<b>3SU1803-0AD00-2AB1</b>	1	1 unit

# Push Button Units and Indicator Lights Enclosures

• Revised •  
07/15/16

## Pushbuttons and indicator lights in the enclosure

Color enclosure top	Number of command points	Enclosure version Command point fittings	Color of actuating element Marking	Number of:		DT	Order No.	PU (UNIT, SET, M)	PS*	
				NC contacts	NO contacts					
<b>Enclosures with standard fittings</b>										
<b>Metal version</b>										
	Yellow	1	Center command point A = EMERGENCY STOP mushroom pushbutton, 40 mm, with positive latching function according to ISO 13850, Rotate to unlatch	Red	1	0	▶	<b>3SU1851-0NA00-2AA2</b>	1	1 unit
					2	0	▶		<b>3SU1851-0NB00-2AA2</b>	1
	Yellow	1	With protective collar A = EMERGENCY STOP mushroom pushbutton, 40 mm, with positive latching function according to ISO 13850, Rotate to unlatch	Red	1	0	▶	<b>3SU1851-0NA00-2AC2</b>	1	1 unit
					2	1	B	<b>3SU1851-0NB00-2AC2</b>	1	1 unit
					2	1	B	<b>3SU1851-0ND00-2AC2</b>	1	1 unit
	Gray	1	With recess for labeling plate A = pushbutton	A = green, I	0	1	B	<b>3SU1851-0AB00-2AB1</b>	1	1 unit
				A = red, O	1	0	B	<b>3SU1851-0AC00-2AB1</b>	1	1 unit
				A = white, I	0	1	B	<b>3SU1851-0AD00-2AB1</b>	1	1 unit
				A = black, O	1	0	B	<b>3SU1851-0AE00-2AB1</b>	1	1 unit
	Gray	2	With recess for labeling plate A = pushbutton / B = pushbutton	A = red, O	1	1	B	<b>3SU1852-0AB00-2AB1</b>	1	1 unit
				B = green, I						
	Gray	3	With recess for labeling plate A = pushbutton / B = pushbutton / C = indicator light	A = black, O	1	1	B	<b>3SU1852-0AC00-2AB1</b>	1	1 unit
				B = white, I						
	Gray	3	With recess for labeling plate A = pushbutton / B = pushbutton / C = indicator light	A = red, O	1	1	B	<b>3SU1853-0AB00-2AB1</b>	1	1 unit
				B = green, I						
	Gray	3	With recess for labeling plate A = pushbutton / B = pushbutton / C = indicator light	C = clear, without inscription						
				A = red, O	1	2	B	<b>3SU1853-0AD00-2AB1</b>	1	1 unit
				B = black, I						
				C = black, II						

• Revised •  
07/15/16

# Push Button Units and Indicator Lights Enclosures

## Pushbuttons and indicator lights in the enclosure

1  
2  
3  
4  
5  
6  
7  
8  
9  
10

Number of command points	Product function / EMERGENCY STOP function	DT	Order No.	PU (UNIT, SET, M)	PS*
--------------------------	--	----	-----------	-------------------	-----

### Customized enclosures<sup>1)</sup>



Plastic version					
1	No	A	3SU1801-0AZ00 K0Y	1	1 unit
	Yes	A	3SU1801-0NZ00 K0Y	1	1 unit
2	No	A	3SU1802-0AZ00 K0Y	1	1 unit
	Yes	A	3SU1802-0NZ00 K0Y	1	1 unit
3	No	A	3SU1803-0AZ00 K0Y	1	1 unit
	Yes	A	3SU1803-0NZ00 K0Y	1	1 unit
4	No	A	3SU1804-0AZ00 K0Y	1	1 unit
	Yes	A	3SU1804-0NZ00 K0Y	1	1 unit
6	No	A	3SU1806-0AZ00 K0Y	1	1 unit
	Yes	A	3SU1806-0NZ00 K0Y	1	1 unit
Metal version					
1	No	A	3SU1851-0AZ00 K0Y	1	1 unit
	Yes	A	3SU1851-0NZ00 K0Y	1	1 unit
2	No	A	3SU1852-0AZ00 K0Y	1	1 unit
	Yes	A	3SU1852-0NZ00 K0Y	1	1 unit
3	No	A	3SU1853-0AZ00K0Y	1	1 unit
	Yes	A	3SU1853-0NZ00 K0Y	1	1 unit
4	No	A	3SU1854-0AZ00 K0Y	1	1 unit
	Yes	A	3SU1854-0NZ00 K0Y	1	1 unit
6	No	A	3SU1856-0AZ00 K0Y	1	1 unit
	Yes	A	3SU1856-0NZ00 K0Y	1	1 unit

<sup>1)</sup> The fittings and labeling of the command points can be chosen using the Configurator on the Internet. The prices depend on the equipment selected; see [www.siemens.com/sirius-act/configurator](http://www.siemens.com/sirius-act/configurator).

### Pushbuttons and indicator lights in the enclosure for AS-Interface

#### Overview

With AS-Interface enclosures, distributed SIRIUS ACT pushbuttons and indicator lights can be quickly connected to the AS-Interface communication system. Using suitable components you can assemble your own enclosures with integrated AS-Interface or flexibly modify existing enclosures.



Enclosures for AS-Interface

#### Enclosures

Color of enclosure top:

- Gray, RAL 7035
- Yellow, RAL 1004, for EMERGENCY STOP

Color of enclosure lower part:

- Black, RAL 9005

#### Equipping with AS-Interface slaves

The following slaves are available for connecting the command points:

- Slave in A/B technology with 4 digital inputs and 3 digital outputs (4 DI / 3 DO)
- Slave with 4 digital inputs and 4 digital outputs (4 DI / 4 DO)
- F slave with 2 safe inputs for EMERGENCY STOP mushroom pushbutton (2 F-DI), also with LED
- F slave with 2 safe inputs and one digital output (2 F-DI + 1 DO)

The following table shows the maximum number of slaves possible:

Number of command points	Number of slaves for enclosures without EMERGENCY STOP	Number of slaves for enclosures with EMERGENCY STOP
1	--	1 x F slave 2 F-DI
2	1 x slave 4 DI/4 DO or 4 DI/3 DO	--
3	1 x slave 4 DI/4 DO or 4 DI/3 DO	1 x slave 4 DI/4 DO or 4 DI/3 DO + 1 x F slave
4	2 x slave 4 DI/4 DO or 4 DI/3 DO	2 x slave 4 DI/4 DO or 4 DI/3 DO + 1 x F slave
6	2 x slave 4 DI/4 DO or 4 DI/3 DO	2 x slave 4 DI/4 DO or 4 DI/3 DO + 1 x F slave

#### Connection

One set of links is required in each case to connect a slave to contact modules, LED modules, and the connection element.

The connection elements are mounted in the front-end cable glands and are used to connect the AS-Interface or bring unused inputs or outputs out of the enclosure.

For connection to AS-Interface, the following options are available:

- Terminal for shaped AS-Interface cable. The cable is contacted by the insulation piercing method and routed past the enclosure on the outside (possible only with plastic enclosure).
- Cable gland for the shaped AS-Interface cable or round cable. The cable is routed into the enclosure (preferable for metal enclosure).
- Connection using M12 plug.

If less than all inputs/outputs of the installed slaves in an enclosure are used for connecting the commanding devices, free inputs and outputs can be routed on request to the outside through an M12 socket on the top or bottom side of the enclosure.

To supply inputs with power, the S+ connection of the slave must be assigned to the socket, for outputs the OUT- connection must be assigned. Addressing is performed using the AS-Interface connections or the integrated addressing socket. An external power supply is not required.

#### Enclosures with standard fittings

Enclosures with standard fittings are available with:

- 1 to 3 command points
- Operational voltage through AS-Interface (approx. 30 V)
- Vertical mounting type
- Plastic enclosures are equipped with plastic actuators and indicators, metal enclosures are equipped with metal actuators and indicators

The enclosures without EMERGENCY STOP each have one module with 4I/3O; the enclosures with EMERGENCY STOP mushroom pushbuttons have a safe AS-Interface slave integrated in the enclosure. Enclosures with EMERGENCY STOP mushroom pushbuttons are fitted with two NC contact modules, which are wired to the safe F slave.

The contact modules and LED modules (with spring-type terminals) of the commanding devices and the AS-Interface slaves are mounted in the base of the enclosure and connected using cables. The plastic enclosures are designed with a connection for the AS-Interface flat cable (the cable is run along the outside of the enclosure). For metal enclosures, the AS-Interface cable is run inside the enclosure.

The enclosures with EMERGENCY STOP mushroom pushbuttons are also available with an M12 connector.

#### Customized enclosures (selection by configurator)

To order customized 3SU18 AS-Interface enclosures with pushbuttons and indicator lights, use the 3SU1 configurator to select the elements for equipping. An electronic order form will be generated for the options.

Configurator see [www.siemens.com/sirius-act/configurator](http://www.siemens.com/sirius-act/configurator)

### Selection and ordering data

Color of enclosure top	Number of command points	Enclosure version Command point fittings	Color, marking	DT	Insulation piercing method		PU (UNIT, SET, M)	PS*
Order No.								

#### Enclosures with standard fittings

##### Plastic version



3SU1801-0NB10-4HB2

Yellow	1	With recess for labeling plate A = EMERGENCY STOP mushroom push-button 40 mm, with positive latching function according to ISO 13850, Rotate to unlatch	Red	B	<b>3SU1801-0NB10-4HB2</b>		1	1 unit
--------	---	--	-----	---	---------------------------	--	---	--------



3SU1802-0AB10-4HB1

Gray	2	With recess for labeling plate A = pushbutton / B = pushbutton	A = red, O B = green, I	B	<b>3SU1802-0AB10-4HB1</b>		1	1 unit
			A = black, O B = white, I	B	<b>3SU1802-0AC10-4HB1</b>		1	1 unit



3SU1803-0AB10-4HB1

	3	With recess for labeling plate A = pushbutton / B = pushbutton / C = indicator light	A = red, O B = green, I C = clear, without inscription	B	<b>3SU1803-0AB10-4HB1</b>		1	1 unit
--	---	---	--	---	---------------------------	--	---	--------

Number of command points	Emergency stop functionality	DT	Order No.	PU (UNIT, SET, M)	PS*
--------------------------	------------------------------	----	-----------	-------------------	-----

#### Customer specific enclosures for AS-Interface

##### Plastic version



1	No	A	<b>3SU1801-0NZ10 K0Y</b>	1	1 unit
2	No	A	<b>3SU1802-0AZ10 K0Y</b>	1	1 unit
	Yes	A	<b>3SU1802-0NZ10 K0Y</b>	1	1 unit
3	No	A	<b>3SU1803-0AZ10 K0Y</b>	1	1 unit
	Yes	A	<b>3SU1803-0NZ10 K0Y</b>	1	1 unit
4	No	A	<b>3SU1804-0AZ10 K0Y</b>	1	1 unit
	Yes	A	<b>3SU1804-0NZ10 K0Y</b>	1	1 unit
6	No	A	<b>3SU1806-0AZ10 K0Y</b>	1	1 unit
	Yes	A	<b>3SU1806-0NZ10 K0Y</b>	1	1 unit

##### Metal version



1	No	A	<b>3SU1851-0NZ10 K0Y</b>	1	1 unit
2	No	A	<b>3SU1852-0AZ10 K0Y</b>	1	1 unit
	Yes	A	<b>3SU1852-0NZ10 K0Y</b>	1	1 unit
3	No	A	<b>3SU1853-0AZ10K0Y</b>	1	1 unit
	Yes	A	<b>3SU1853-0NZ10 K0Y</b>	1	1 unit
4	No	A	<b>3SU1854-0AZ10 K0Y</b>	1	1 unit
	Yes	A	<b>3SU1854-0NZ10 K0Y</b>	1	1 unit
6	No	A	<b>3SU1856-0AZ10 K0Y</b>	1	1 unit
	Yes	A	<b>3SU1856-0NZ10 K0Y</b>	1	1 unit

<sup>1)</sup> The command points and inscription can be configured online via the SIRIUS ACT configurator.  
[www.siemens.com/sirius-act/configurator](http://www.siemens.com/sirius-act/configurator)

# Push Button Units and Indicator Lights Enclosures

• Revised •  
07/15/16

## Modules for enclosures

### Selection and ordering data

	Contact version	Number of NO contacts	Number of NC contacts	DT	Screw terminals		PU (UNIT, SET, M)	PS*				
					Order No.							
<b>Contact modules for base mounting</b>												
	Silver alloy	1	0		ICD1_00448	▶	3SU1400-2AA10-1BA0	1	1 unit			
		0	1		ICD1_00449			▶	3SU1400-2AA10-1CA0	1	1 unit	
		0	1		ICD1_00449			▶	3SU1400-2AA10-1MA0	1	1 unit	
												
	Silver alloy	1	0		ICD1_00448	B	▶	3SU1400-2AA10-3BA0	1	1 unit		
		0	1		ICD1_00449	B			▶	3SU1400-2AA10-3CA0	1	1 unit
		0	1		ICD1_00449	B			▶	3SU1400-2AA10-3MA0	1	1 unit
												

⊕ Positive opening according to IEC 60947-5-1, Annex K.  
Can be used with 3SK11 safety relays or the 3RK3 Modular Safety System; see page 11/1 onwards.

Certificate: 

	Operational voltage at AC	Operational voltage at DC	Color	DT	Screw terminals		PU (UNIT, SET, M)	PS*			
					Order No.						
<b>LED modules<sup>1)</sup> for base mounting</b>											
	24	24	Amber	B	▶	3SU1401-2BB00-1AA0	1	1 unit			
			Red	▶					3SU1401-2BB20-1AA0	1	1 unit
			Yellow	B					3SU1401-2BB30-1AA0	1	1 unit
			Green	▶					3SU1401-2BB40-1AA0	1	1 unit
			Blue	B					3SU1401-2BB50-1AA0	1	1 unit
			White	▶					3SU1401-2BB60-1AA0	1	1 unit
			110	--					Amber	B	▶
Red	B	3SU1401-2BC20-1AA0			1	1 unit					
Yellow	B	3SU1401-2BC30-1AA0			1	1 unit					
Green	B	3SU1401-2BC40-1AA0			1	1 unit					
Blue	B	3SU1401-2BC50-1AA0			1	1 unit					
White	B	3SU1401-2BC60-1AA0			1	1 unit					
230	--	Amber	B	▶	3SU1401-2BF00-1AA0	1	1 unit				
		Red	B					3SU1401-2BF20-1AA0	1	1 unit	
		Yellow	B					3SU1401-2BF30-1AA0	1	1 unit	
		Green	B					3SU1401-2BF40-1AA0	1	1 unit	
		Blue	B					3SU1401-2BF50-1AA0	1	1 unit	
		White	B					3SU1401-2BF60-1AA0	1	1 unit	

<sup>1)</sup> Only for use with SIRIUS commanding and signaling devices.

• Revised •  
07/15/16

# Push Button Units and Indicator Lights Enclosures

## Modules for enclosures

1

2

3

4

5

6

7

8

9

10

Operational voltage at AC	Operational voltage at DC	Color	DT	Spring-type terminals	PU (UNIT, SET, M)	PS*
V	V			Order No.		
<b>LED modules<sup>1)</sup> for base mounting</b>						
24	24	Amber	B	3SU1401-2BB00-3AA0	1	1 unit
		Red	▶	3SU1401-2BB20-3AA0	1	1 unit
		Yellow	B	3SU1401-2BB30-3AA0	1	1 unit
		Green	▶	3SU1401-2BB40-3AA0	1	1 unit
		Blue	B	3SU1401-2BB50-3AA0	1	1 unit
		White	▶	3SU1401-2BB60-3AA0	1	1 unit
110	--	Amber	B	3SU1401-2BC00-3AA0	1	1 unit
		Red	B	3SU1401-2BC20-3AA0	1	1 unit
		Yellow	B	3SU1401-2BC30-3AA0	1	1 unit
		Green	B	3SU1401-2BC40-3AA0	1	1 unit
		Blue	B	3SU1401-2BC50-3AA0	1	1 unit
		White	B	3SU1401-2BC60-3AA0	1	1 unit
230	--	Amber	B	3SU1401-2BF00-3AA0	1	1 unit
		Red	B	3SU1401-2BF20-3AA0	1	1 unit
		Yellow	B	3SU1401-2BF30-3AA0	1	1 unit
		Green	B	3SU1401-2BF40-3AA0	1	1 unit
		Blue	B	3SU1401-2BF50-3AA0	1	1 unit
		White	B	3SU1401-2BF60-3AA0	1	1 unit



3SU1401-2BB20-3AA0

<sup>1)</sup> Only for use with SIRIUS commanding and signaling devices.

Operational voltage at AC	Operational voltage at DC	Color	DT	Screw terminals	PU (UNIT, SET, M)	PS*
V	V			Order No.		
<b>LED modules<sup>1)</sup> for base mounting - wide voltage range</b>						
6 ... 24	6 ... 24	Amber	B	3SU1401-2BG00-1AA0	1	1 unit
		Red	▶	3SU1401-2BG20-1AA0	1	1 unit
		Yellow	B	3SU1401-2BG30-1AA0	1	1 unit
		Green	▶	3SU1401-2BG40-1AA0	1	1 unit
		Blue	▶	3SU1401-2BG50-1AA0	1	1 unit
		White	▶	3SU1401-2BG60-1AA0	1	1 unit
24 ... 230	24 ... 230	Amber	B	3SU1401-2BH00-1AA0	1	1 unit
		Red	B	3SU1401-2BH20-1AA0	1	1 unit
		Yellow	B	3SU1401-2BH30-1AA0	1	1 unit
		Green	B	3SU1401-2BH40-1AA0	1	1 unit
		Blue	B	3SU1401-2BH50-1AA0	1	1 unit
		White	▶	3SU1401-2BH60-1AA0	1	1 unit
<b>Spring-type terminals</b>						
6 ... 24	6 ... 24	Amber	B	3SU1401-2BG00-3AA0	1	1 unit
		Red	B	3SU1401-2BG20-3AA0	1	1 unit
		Yellow	B	3SU1401-2BG30-3AA0	1	1 unit
		Green	B	3SU1401-2BG40-3AA0	1	1 unit
		Blue	B	3SU1401-2BG50-3AA0	1	1 unit
		White	B	3SU1401-2BG60-3AA0	1	1 unit
24 ... 230	24 ... 230	Amber	B	3SU1401-2BH00-3AA0	1	1 unit
		Red	B	3SU1401-2BH20-3AA0	1	1 unit
		Yellow	B	3SU1401-2BH30-3AA0	1	1 unit
		Green	B	3SU1401-2BH40-3AA0	1	1 unit
		Blue	B	3SU1401-2BH50-3AA0	1	1 unit
		White	B	3SU1401-2BH60-3AA0	1	1 unit
<b>Order No.</b>						



3SU1401-2BG60-1AA0



3SU1401-2BG20-3AA0

<sup>1)</sup> Only for use with SIRIUS commanding and signaling devices.

<b>LED test modules<sup>1)</sup> for base mounting</b>						
12 ... 240	12 ... 240		▶	3SU1400-2CK10-1AA0	1	1 unit





3SU1401-1CK10-1AA0

<sup>1)</sup> Only for use with SIRIUS commanding and signaling devices.

# Push Button Units and Indicator Lights Enclosures

• Revised •  
07/15/16

## Modules for enclosures

	Operational voltage	Slave type	Number of digital inputs		Number of digital outputs	DT	Push-in terminals Order No.	<input type="checkbox"/> PU (UNIT, SET, M)	PS*	
			Standard	Safety-related						
<b>AS-Interface modules for base mounting</b>										
 3SU1400-2EJ10-6AA0	30 V	4 DI/3 DO AB	4	0	3	B	<b>3SU1400-2EJ10-6AA0</b> <b>3SU1400-2EK10-6AA0</b> <b>3SU1400-2EA10-6AA0</b> <b>3SU1401-2EE20-6AA0</b>	<input type="checkbox"/>	1	1 unit
		4 DI/4 DO	4	0	4	B			1	1 unit
		2 F-DI	0	2	0	B			1	1 unit
		2 F-DI + 1LED	0	2	1	B			1	1 unit
for LED control										
<b>IO-Link modules for base mounting</b>										
 3SU1400-2EJ10-6AA0	24 V	Freely programmable (default 6 DI/2 DO)	0-8	0	0-8	B	<b>3SU1400-2HL10-6AA0</b> <b>3SU1400-2HM10-6AA0</b> <b>3SU1400-2HK10-6AA0</b> <b>3SU1400-2HN10-6AA0</b>	<input type="checkbox"/>	1	1 unit
		4 DI/4 DO	4	0	4	B			1	1 unit
		6 DI/2 DO	6	0	2	B			1	1 unit
		2 DI/6 DO	2	0	6	B			1	1 unit



#### Overview

##### Equipment

The two-hand operation consoles are pre-equipped with commanding devices. In the case of plastic enclosures the command points are equipped as standard with actuators and indicators made of plastic, in the case of metal enclosures they are equipped with actuators and indicators made of metal.

The standard equipment comprises:

- 2 black mushroom pushbuttons, Ø 40 mm, 1 NO + 1 NC
- 1 red EMERGENCY STOP mushroom pushbutton according to ISO 13850, Ø 40 mm, with positive latching, 2 NC

The plastic version can be retrofitted with up to 8 customized command points. The surface of the console has premachined breaking points for this purpose.

#### Application

The two-hand operation consoles are required for use with machines and systems that have hazardous areas, in order to direct both hands of the operator to one position.

The operation consoles are primarily used on presses, stamping machines, printing presses and paper converting machines, in the chemical industry and in the rubber and plastics industries.

The control command is given by pressing the two mushroom pushbuttons on the sides simultaneously (within 0.5 s of each other) and must be maintained for as long as a hazard exists.

For the further processing of control commands, suitable evaluation units are used, e.g. 3SK11 safety relays or the 3RK3 Modular Safety System.

#### Standards

The two-hand operation consoles comply with the requirements of EN 574.

#### Selection and ordering data

Version of actuating element Unlatching method	Color of actuating element	Number of NO contacts	Number of NC contacts	DT	Order No.	PU (UNIT, SET, M)	PS*
---	----------------------------	-----------------------	-----------------------	----	-----------	-------------------	-----

##### Enclosures - Two-hand operation consoles

##### Plastic enclosures



3SU1803-3NB00-1AE1

None	--	0	0	B	<b>3SU1803-3AA00-1AA1</b>	1	1 unit
A = mushroom pushbutton, pull-to unlatch mechanism B = EMERGENCY STOP mushroom pushbutton, rotate-to-unlatch mechanism C = mushroom pushbutton, pull-to-unlatch mechanism	A = black B = red C = black	2	4	B	<b>3SU1803-3NB00-1AE1</b>	1	1 unit

##### Metal enclosures



3SU1853-3AA00-0AA1

None	--	0	0	B	<b>3SU1853-3AA00-0AA1</b>	1	1 unit
------	----	---	---	---	---------------------------	---	--------



3SU1853-3NB00-1AA1

A = mushroom pushbutton, pull-to unlatch mechanism B = EMERGENCY STOP mushroom pushbutton, rotate-to-unlatch mechanism C = mushroom pushbutton, pull-to-unlatch mechanism	A = black B = red C = black	2	4	B	<b>3SU1853-3NB00-1AA1</b>	1	1 unit
---	-----------------------------------	---	---	---	---------------------------	---	--------



3SU1853-3NB00-1AD1

		2	4	B	<b>3SU1853-3NB00-1AD1</b>	1	1 unit
--	--	---	---	---	---------------------------	---	--------

Version	Material	Color	DT	Order No.	PU (UNIT, SET, M)	PS*
---------	----------	-------	----	-----------	-------------------	-----

##### Accessories



3SU1950-0HN10-0AA0

<b>Stands for two-hand operation console</b>	Metal	Silver	B	<b>3SU1950-0HN10-0AA0</b>	1	1 unit
--	-------	--------	---	---------------------------	---	--------

### Insert labels

#### Overview

Labels can be inserted for identification purposes in pushbuttons (clear) and in illuminated pushbuttons with a flat button. These insert labels are made of semi-transparent plastic with black inscription; they can be fitted in any 90° angle.



#### Inscription

The inscription is in upper/lower case, all words begin with upper case letters. Graphic symbols, including those not listed in the catalog, are according to ISO 7000 or IEC 60417.

The insert labels without inscription are suitable for user marking with permanent pen.

For customized inscription, see "Options" on page 10/124.

#### Selection and ordering data

	Color	Marking	DT	Order No.	PU (UNIT, SET, M)	PS*
<b>Insert labels</b>						
 3SU1900-0AB71-0AA0	<b>For self-inscription</b>					
	Clear/Black (label/lettering)	None	B	<b>3SU1900-0AB71-0AA0</b>	100	10 units
 3SU1900-0AB71-0DN0	<b>For customized inscription</b>					
	Clear/Black (label/lettering)	None	B	<b>3SU1900-0AB71-0AZ0</b>	100	10 units
<b>Inscription in English</b>						
 3SU1900-0AB71-0DN0	Clear/Black (label/lettering)	On	B	<b>3SU1900-0AB71-0DJ0</b>	100	10 units
		Off	B	<b>3SU1900-0AB71-0DK0</b>	100	10 units
		Up	B	<b>3SU1900-0AB71-0DL0</b>	100	10 units
		Down	B	<b>3SU1900-0AB71-0DM0</b>	100	10 units
		Forward+	B	<b>3SU1900-0AB71-0DN0</b>	100	10 units
		Right	B	<b>3SU1900-0AB71-0DQ0</b>	100	10 units
		Left	B	<b>3SU1900-0AB71-0DR0</b>	100	10 units
		Stop	B	<b>3SU1900-0AB71-0DS0</b>	100	10 units
		Start	B	<b>3SU1900-0AB71-0DT0</b>	100	10 units
		Reset	B	<b>3SU1900-0AB71-0DU0</b>	100	10 units
		Test	B	<b>3SU1900-0AB71-0DV0</b>	100	10 units
		Open	B	<b>3SU1900-0AB71-0DW0</b>	100	10 units
		Close	B	<b>3SU1900-0AB71-0DX0</b>	100	10 units
		Running	B	<b>3SU1900-0AB71-0EB0</b>	100	10 units
		Fast	B	<b>3SU1900-0AB71-0EE0</b>	100	10 units
		Slow	B	<b>3SU1900-0AB71-0EF0</b>	100	10 units

• Revised •  
08/31/15

# Push Button Units and Indicator Lights

Labels

Insert labels

1

2

3

4

5

6

7

8

9

10

Color	Marking	Symbol No.	DT	Order No.	PU (UNIT, SET, M)	PS*
-------	---------	------------	----	-----------	-------------------	-----

Insert labels

**With symbol (ON/OFF)**



3SU1900-0AB71-0QC0

Black/White (label/lettering)	O I	--	B	<b>3SU1900-0AB16-0QE0</b>	1	10 units
White/Black (label/lettering)	O I	--	B	<b>3SU1900-0AB61-0QE0</b>	1	10 units
Clear/Black (label/lettering)	O	5008 IEC	A	<b>3SU1900-0AB71-0QA0</b>	100	10 units
	I	5007 IEC	A	<b>3SU1900-0AB71-0QB0</b>	100	10 units
	II	--	B	<b>3SU1900-0AB71-0QC0</b>	100	10 units
	III	--	B	<b>3SU1900-0AB71-0QD0</b>	100	10 units

**With symbol (graphic)**



3SU1900-0AB71-0QT0



3SU1900-0AB71-0RB0



3SU1900-0AB71-0RN0

Clear/Black (label/lettering)	→	ARROW DIRECTION TO RIGHT	5022 IEC	A	<b>3SU1900-0AB71-0QR0</b>	100	10 units
	↗	ARROW DIRECTION UP	--	B	<b>3SU1900-0AB71-0QS0</b>	100	10 units
	↻	CLOCKWISE ROTATION	0004 ISO	B	<b>3SU1900-0AB71-0QT0</b>	100	10 units
	↺	COUNTERCLOCKWISE ROTATION	--	B	<b>3SU1900-0AB71-0QU0</b>	100	10 units
	⚡	RAPID TRAVERSE	0266 ISO	B	<b>3SU1900-0AB71-0QV0</b>	100	10 units
	⚡	FEED	--	B	<b>3SU1900-0AB71-0QW0</b>	100	10 units
	+	INCREASE, PLUS	5005 IEC	B	<b>3SU1900-0AB71-0QX0</b>	100	10 units
	-	DECREASE, MINUS	5006 IEC	B	<b>3SU1900-0AB71-0QY0</b>	100	10 units
	⚙	ELECTRIC MOTOR	0011 ISO	B	<b>3SU1900-0AB71-0RA0</b>	100	10 units
	🔊	HORN	5014 IEC	B	<b>3SU1900-0AB71-0RB0</b>	100	10 units
	🚰	WATER TAP	--	B	<b>3SU1900-0AB71-0RC0</b>	100	10 units
	🚰	PUMP	0134 ISO	B	<b>3SU1900-0AB71-0RD0</b>	100	10 units
	🚰	COOLANT PUMP	0355 ISO	B	<b>3SU1900-0AB71-0RE0</b>	100	10 units
	🔒	LOCK, TIGHTEN	--	B	<b>3SU1900-0AB71-0RF0</b>	100	10 units
	🔓	UNLOCK, UNCLAMP	--	B	<b>3SU1900-0AB71-0RG0</b>	100	10 units
	🔒	BRAKE	--	B	<b>3SU1900-0AB71-0RH0</b>	100	10 units
	🔓	RELEASE BRAKE	0021 ISO	B	<b>3SU1900-0AB71-0RJ0</b>	100	10 units
	🔒	INTERLOCK	0022 ISO	B	<b>3SU1900-0AB71-0RK0</b>	100	10 units
	🔓	UNLOCK	0023 ISO	B	<b>3SU1900-0AB71-0RL0</b>	100	10 units
	⚙	SETTING	--	B	<b>3SU1900-0AB71-0RM0</b>	100	10 units
	⚡	ON-OFF MOMENTARY CONTACT TYPE	5011 IEC	B	<b>3SU1900-0AB71-0RN0</b>	100	10 units
	👤	MANUAL OPERATION	0096 ISO	B	<b>3SU1900-0AB71-0RP0</b>	100	10 units
	🔄	AUTOMATIC CYCLE	0017 ISO	B	<b>3SU1900-0AB71-0RQ0</b>	100	10 units
	👤	SUCTION	--	B	<b>3SU1900-0AB71-0RR0</b>	100	10 units
	👤	BLOWING	--	B	<b>3SU1900-0AB71-0RS0</b>	100	10 units

### Insert labels

#### Options

##### Customized inscriptions

The labels can be inscribed with text and symbols not listed in the ordering data.

By default, a letter height of 4 mm (for a single line of text) or 3 mm (for two or three lines of text) is used for text inscriptions.

The typeface used is Arial. Other letter heights and typefaces are possible, but must be specified when ordering.

For round insert labels, the maximum possible number of characters per line is:

- 10 characters for one line of text
- 8 characters for 2 lines of text
- 6 characters for 3 lines of text, but 10 characters in the middle line

##### Examples for customized inscription



Two-line inscription in upper/lower case lettering (Q0Y)



Single-line inscription in upper case lettering (Q1Y)



Three-line inscription in lower case letters (Q2Y)

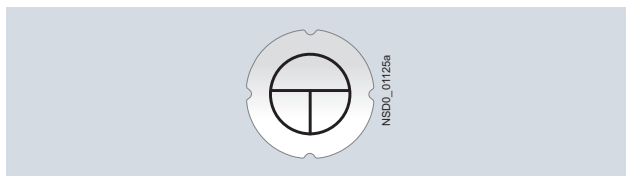

Symbol number 5011 according to IEC 60417 (Q3Y)

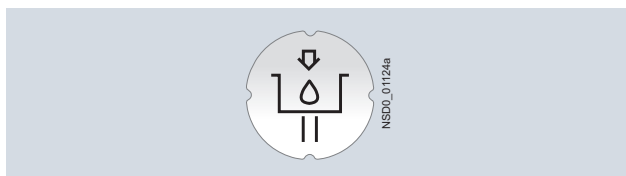

Any symbol according to order form supplement (Q9Y)

##### Ordering notes

Append the following order codes to the Order No.:

- Text line(s) in upper/lower case, upper case always for beginning of line (e.g. "Lift / Off"): **Q0Y**
- Text line(s) in upper case (e.g. "LIFT"): **Q1Y**
- Text line(s) in lower case (e.g. "lift / off / lower"): **Q2Y**
- Text line(s) in upper/lower case, all words begin with upper case letters (e.g. "On Off"): **Q5Y**
- Symbol with number according to ISO 7000 or IEC 60417: **Q3Y**
- Any inscription or symbol according to order form supplement: **Q9Y**

When ordering, specify the required inscription in plain text in addition to the article number and order code. In the case of special inscriptions with words in languages other than German, give the exact spelling and specify the language. In the case of multi-line inscriptions, the text must be assigned to the respective line, e.g. "Z1 = Lift, Z2 = Lower". For long words you can also specify the end-of-line division; see [ordering example 1](#)

Symbols can also be ordered with numbers according to ISO 7000 or IEC 60417; see [ordering examples 2 and 3](#)

The SIRIUS ACT Configurator must be used to select customized inscriptions and symbols (order code Q9Y). In this case a "CIN" (Configuration Identification Number) is generated for placement of future orders. It is then possible to place an order directly using the CIN and the SIRIUS ACT Configurator (Mall shopping cart) or via the standard order channels.

Standard ordering channels:

- Configurator: [www.siemens.com/sirius-act/configurator](http://www.siemens.com/sirius-act/configurator)
- Electronic Catalog CA 01 on DVD
- Industry Mall: [www.usa.siemens.com/industrymall](http://www.usa.siemens.com/industrymall)

##### Ordering example 1

A label with 2 lines of text is required:

3SU1900-0AB71-0AZ0  
Q1Y  
Z1 = LIFT  
Z2 = LOWER

##### Ordering example 2

A label inscribed with symbol No. 5011 according to IEC 60417 is required:

3SU1900-0AB71-0AZ0  
Q3Y  
Z = 5011 IEC

##### Ordering example 3

A label inscribed with symbol No. 1118 according to ISO 7000 is required:

3SU1900-0AB71-0AZ0  
Q3Y  
Z = 1118 ISO

• Revised •  
08/31/15





# Push Button Units and Indicator Lights

Labels

## Label holders for labeling plates

1  
2  
3  
4  
5  
6  
7  
8  
9  
10

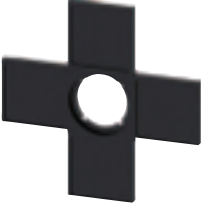
### Selection and ordering data

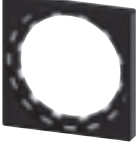
Label holder shape	Label holder color	Label fastening method	Labeling plate size		DT	Order No.	PU (UNIT, SET, M)	PS*		
			Height mm	Width mm						
<b>Label holders for labeling plates</b>										
	With rounded bottom	Black	Self-adhesive	12.5	27	▶	<b>3SU1900-0AG10-0AA0</b>	100	10 units	
				17.5	27	A		<b>3SU1900-0AH10-0AA0</b>	100	10 units
				27	27	▶		<b>3SU1900-0AJ10-0AA0</b>	100	10 units
	Snap-on	12.5	27	A	<b>3SU1900-0AR10-0AA0</b>	100	10 units			
		17.5	27	A	<b>3SU1900-0AS10-0AA0</b>	100	10 units			
		27	27	A	<b>3SU1900-0AT10-0AA0</b>	100	10 units			
3SU1900-0AG10-0AA0										
	With square bottom	Black	Self-adhesive	12.5	27	B	<b>3SU1900-0AN10-0AA0</b>	100	1 unit	
				17.5	27	B		<b>3SU1900-0AP10-0AA0</b>	100	1 unit
				27	27	B		<b>3SU1900-0AQ10-0AA0</b>	100	1 unit
				3SU1900-0AN10-0AA0						
<b>Label holders for labeling plates for coordinate switches</b>										
	With square bottom	Black	Self-adhesive	27	27	A	<b>3SU1900-0AL10-0AA0</b>	1	1 unit	
				3SU1900-0AL10-0AA0						
	Cross	Black	Self-adhesive	27	27	B	<b>3SU1900-0AM10-0AA0</b>	1	1 unit	
				3SU1900-0AM10-0AA0						
<b>Label holders for labeling plates for twin pushbuttons</b>										
	Rectangular	Black	Self-adhesive	12.5	27	▶	<b>3SU1900-0AK10-0AA0</b>	100	10 units	
3SU1900-0AK10-0AA0										
<b>Single frames</b>										
	Square	--	--	29.8	29.8	A	<b>3SU1900-0AX10-0AA0</b>	1	10 units	
3SU1900-0AX10-0AA0										

## Labels

### Labeling plates

#### Overview

The backing plates consist of a black molded-plastic label holder and a labeling plate (black with white print or silver-colored with black print) for sticking or snapping in place. They are not suitable for EMERGENCY STOP buttons. Note mounting dimensions!

#### Inscription

The inscription is in upper/lower case, all words begin with upper case letters. Graphic symbols, including those not listed in the catalog, are according to ISO 7000 or IEC 60417.

For customized inscription, see "Options" on page 10/131.





#### Labeling plates for sticking/snapping in place

The labels are available in three sizes:

- 12.5 mm × 27 mm
- 17.5 mm × 27 mm
- 27 mm × 27 mm

For mounting the labeling plates, you can choose between label holders for stick-on or snap-on mounting.

#### Selection and ordering data

Color	Marking	Symbol No.	DT	Order No.	PU (UNIT, SET, M)	PS*
<b>Labeling plates 12.5 mm x 27 mm</b>						
<b>For self-inscription</b>						
	Black/White (label/lettering)	None	--	▶ <b>3SU1900-0AC16-0AA0</b>	100	10 units
	<b>For custom inscription</b>					
	Black/White (label/lettering)	None	--	▶ <b>3SU1900-0AB71-0AZ0</b>	100	10 units
	<b>Inscription in English</b>					
	Black/White (label/lettering)	On	--	B <b>3SU1900-0AC16-0DJ0</b>	100	10 units
		Off	--	B <b>3SU1900-0AC16-0DK0</b>	100	10 units
		Up	--	B <b>3SU1900-0AC16-0DL0</b>	100	10 units
		Down	--	B <b>3SU1900-0AC16-0DM0</b>	100	10 units
		Forward	--	▶ <b>3SU1900-0AC16-0DN0</b>	100	10 units
		Reverse	--	B <b>3SU1900-0AC16-0DP0</b>	100	10 units
		Right	--	B <b>3SU1900-0AC16-0DQ0</b>	100	10 units
		Left	--	B <b>3SU1900-0AC16-0DR0</b>	100	10 units
		Stop	--	▶ <b>3SU1900-0AC16-0DS0</b>	100	10 units
		Start	--	▶ <b>3SU1900-0AC16-0DT0</b>	100	10 units
		Reset	--	B <b>3SU1900-0AC16-0DU0</b>	100	10 units
		Test	--	B <b>3SU1900-0AC16-0DV0</b>	100	10 units
		Open	--	▶ <b>3SU1900-0AC16-0DW0</b>	100	10 units
		Close	--	▶ <b>3SU1900-0AC16-0DX0</b>	100	10 units
		Jog	--	B <b>3SU1900-0AC16-0DE0</b>	100	10 units
		Running	--	B <b>3SU1900-0AC16-0EB0</b>	100	10 units
		Fault	--	B <b>3SU1900-0AC16-0EC0</b>	100	10 units
		Run	--	B <b>3SU1900-0AC16-0ED0</b>	100	10 units
		Stop Start	--	B <b>3SU1900-0AC16-0DC0</b>	100	10 units
		Off On	--	▶ <b>3SU1900-0AC16-0DH0</b>	100	10 units
	Power off	--	B <b>3SU1900-0AC16-0DF0</b>	100	10 units	
	Power on	--	B <b>3SU1900-0AC16-0DG0</b>	100	10 units	
	Man O Auto	--	B <b>3SU1900-0AC16-0DY0</b>	100	10 units	
	Man Auto	--	B <b>3SU1900-0AC16-0EA0</b>	100	10 units	
	Hand Auto	--	B <b>3SU1900-0AC16-0DB0</b>	100	10 units	
	Hand O Auto	--	B <b>3SU1900-0AC16-0DD0</b>	100	10 units	
<b>With symbol</b>						
	Black/White (label/lettering)	O	--	B <b>3SU1900-0AC16-0QA0</b>	100	10 units
		I	--	B <b>3SU1900-0AC16-0QB0</b>	100	10 units
		O I	--	B <b>3SU1900-0AC16-0QG0</b>	100	10 units
		1 2	--	B <b>3SU1900-0AC16-0QJ0</b>	100	10 units
		↑	ARROW DIRECTION UP	--	B <b>3SU1900-0AC16-0QS0</b>	100



# Push Button Units and Indicator Lights

## Labels

• Revised •

08/31/15

### Labeling plates

Color	Marking	Symbol No.	DT	Order No.	PU (UNIT, SET, M)	PS*	
<b>Labeling plates 17.5 mm x 27 mm</b>							
<b>For self-inscription</b>							
	Black/White (label/lettering)	None	--	▶	3SU1900-0AD16-0AA0	100 10 units	
	<b>For custom inscription</b>						
	Black/White (label/lettering)	None	--	▶	3SU1900-0AD16-0AZ0	100 10 units	
<b>Inscription in English</b>							
	Black/White (label/lettering)	Stop Start	--	B	3SU1900-0AD16-0DC0	100 10 units	
		On	--	B	3SU1900-0AD16-0DJ0	100 10 units	
		Off	--	B	3SU1900-0AD16-0DK0	100 10 units	
		Up	--	B	3SU1900-0AD16-0DL0	100 10 units	
		Down	--	B	3SU1900-0AD16-0DM0	100 10 units	
		Forward	--	B	3SU1900-0AD16-0DN0	100 10 units	
		Reverse	--	B	3SU1900-0AD16-0DP0	100 10 units	
		Right	--	B	3SU1900-0AD16-0DQ0	100 10 units	
		Stop	--	B	3SU1900-0AD16-0DS0	100 10 units	
		Start	--	B	3SU1900-0AD16-0DT0	100 10 units	
		Open	--	B	3SU1900-0AD16-0DW0	100 10 units	
		Close	--	B	3SU1900-0AD16-0DX0	100 10 units	
		Man Auto	--	B	3SU1900-0AD16-0EA0	100 10 units	
		Running	--	B	3SU1900-0AD16-0EB0	100 10 units	
		Fault	--	B	3SU1900-0AD16-0EC0	100 10 units	
	Hand Auto	--	B	3SU1900-0AD16-0DB0	100 10 units		
<b>With symbol</b>							
	Black/White (label/lettering)	O	5008 IEC	B	3SU1900-0AD16-0QA0	100 10 units	
		I	5007 IEC	B	3SU1900-0AD16-0QB0	100 10 units	
		O I	--	B	3SU1900-0AD16-0QG0	100 10 units	
		→	ARROW DIRECTION TO RIGHT	5022 IEC	B	3SU1900-0AD16-0QR0	100 10 units
		↑	ARROW DIRECTION UP	--	B	3SU1900-0AD16-0QS0	100 10 units



• Revised •  
08/31/15

# Push Button Units and Indicator Lights

Labels

## Labeling plates

1

2

3

4

5

6

7

8

9

10

Color	Marking	Symbol No.	DT	Order No.	PU (UNIT, SET, M)	PS*
-------	---------	------------	----	-----------	-------------------------	-----

### Labeling plates 17.5 mm x 27 mm

#### For self-inscription



Silver/Black  
(label/lettering) None

--

A

**3SU1900-0AD81-0AA0**

100

10 units

#### For custom inscription

Silver/Black  
(label/lettering) None

--

A

**3SU1900-0AD81-0AZ0**

100

10 units

3SU1900-0AD81-0AA0

#### Inscription in English



Silver/Black  
(label/lettering)

On

--

B

**3SU1900-0AD81-0DJ0**

100

10 units

Off

--

B

**3SU1900-0AD81-0DK0**

100

10 units

Stop

--

B

**3SU1900-0AD81-0DS0**

100

10 units

Start

--

B

**3SU1900-0AD81-0DT0**

100

10 units

Reset

--

B

**3SU1900-0AD81-0DU0**

100

10 units

Man O Auto

--

B

**3SU1900-0AD81-0DY0**

100

10 units

Fault

--

B

**3SU1900-0AD81-0EC0**

100

10 units

Hand O Auto

--

B

**3SU1900-0AD81-0DB0**

100

10 units

3SU1900-0AD81-0EC0

#### With symbol



Silver/Black  
(label/lettering)

O

5008 IEC

B

**3SU1900-0AD81-0QA0**

100

10 units

I

5007 IEC

B

**3SU1900-0AD81-0QB0**

100

10 units

O I

--

B

**3SU1900-0AD81-0QG0**

100

10 units

I O II

--

B

**3SU1900-0AD81-0QK0**

100

10 units

1 O 2

--

B

**3SU1900-0AD81-0QL0**

100

10 units

→ ARROW DIRECTION  
TO RIGHT

5022 IEC

B

**3SU1900-0AD81-0QR0**

100

10 units

↑ ARROW DIRECTION  
UP

--

B

**3SU1900-0AD81-0QS0**

100

10 units

3SU1900-0AD81-0QG0





# Push Button Units and Indicator Lights

## Labels

• Revised •

08/31/15

### Labeling plates

Color	Marking	Symbol No.	DT	Order No.	PU (UNIT, SET, M)	PS*
<b>Labeling plates 27 mm x 27 mm</b>						
<b>For self-inscription</b>						
	Black/White (label/lettering)	None	--	▶	<b>3SU1900-0AE16-0AA0</b>	100 10 units
	<b>For custom inscription</b>					
	Black/White (label/lettering)	None	--	▶	<b>3SU1900-0AE16-0AZ0</b>	100 10 units
3SU1900-0AE16-0AA0						
<b>For self-inscription</b>						
	Silver/Black (label/lettering)			A	<b>3SU1900-0AE81-0AA0</b>	100 10 units
	<b>For custom inscription</b>					
	Silver/Black (label/lettering)		--	A	<b>3SU1900-0AE81-0AZ0</b>	100 10 units
3SU1900-0AE81-0AA0						
<b>Inscription in English</b>						
	Black/White (label/lettering)	On	--	B	<b>3SU1900-0AE16-0DJ0</b>	100 10 units
		Off	--	B	<b>3SU1900-0AE16-0DK0</b>	100 10 units
		Up	--	B	<b>3SU1900-0AE16-0DL0</b>	100 10 units
		Down	--	B	<b>3SU1900-0AE16-0DM0</b>	100 10 units
		Forward	--	B	<b>3SU1900-0AE16-0DN0</b>	100 10 units
		Reverse	--	B	<b>3SU1900-0AE16-0DP0</b>	100 10 units
		Stop	--	B	<b>3SU1900-0AE16-0DS0</b>	100 10 units
		Start	--	B	<b>3SU1900-0AE16-0DT0</b>	100 10 units
		EMERGENCY STOP	--	B	<b>3SU1900-0AE16-0DA0</b>	100 10 units
		Stop Start	--	B	<b>3SU1900-0AE16-0DC0</b>	100 10 units
3SU1900-0AE16-0DK0		Hand Auto	--	B	<b>3SU1900-0AE16-0DB0</b>	100 10 units
<b>With symbol</b>						
	Black/White (label/lettering)	O I	--	B	<b>3SU1900-0AE16-0QG0</b>	100 10 units
		→	ARROW DIRECTION TO RIGHT	5022 IEC	B	<b>3SU1900-0AE16-0QR0</b>
3SU1900-0AE16-0QG0						

## Options

### Customized inscriptions

The labels can be inscribed with text and symbols not listed in the ordering data.

The following letter heights are used as standard for text inscriptions:

- Label size 12.5 mm × 27 mm: 3 lines with letter height 4 mm (1-line), 3.5 mm (2-line) or 2.5 mm (3-line)
- Label size 17.5 mm × 27 mm: 3 lines with letter height 4 mm (1- to 2-line) or 3 mm (3-line)
- Label size 27 mm × 27 mm: 5 lines with letter height 4 mm (1- to 5-line)

Up to 11 characters per line are possible. The typeface used is Arial. Other letter heights and typefaces are possible, but must be specified when ordering.

#### Examples for customized inscription



Two-line inscription in upper/lower case lettering (Q0Y)

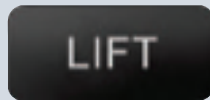

Single-line inscription in upper case lettering (Q1Y)

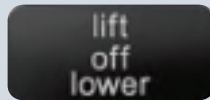

Three-line inscription in lower case letters (Q2Y)



Symbol number 5011 according to IEC 60417 (Q3Y)



Any symbol according to order form supplement (Q9Y)

### Ordering notes

Append the following order codes to the Order No.:

- Text line(s) in upper/lower case, upper case always for beginning of line (e.g. "Lift / Off"): **Q0Y**
- Text line(s) in upper case (e.g. "LIFT"): **Q1Y**
- Text line(s) in lower case (e.g. "lift / off / lower"): **Q2Y**
- Text line(s) in upper/lower case, all words begin with upper case letters (e.g. "On Off"): **Q5Y**
- Symbol with number according to ISO 7000 or IEC 60417: **Q3Y**
- Any inscription or symbol according to order form supplement: **Q9Y**

When ordering, specify the required inscription in plain text in addition to the article number and order code. In the case of special inscriptions with words in languages other than German, give the exact spelling and specify the language.

In the case of multi-line inscriptions, the text must be assigned to the respective line, e.g. "Z1 = Lift, Z2 =Lower".

For long words you can also specify the end-of-line division; see [ordering example 1](#)

Symbols can also be ordered with numbers according to ISO 7000 or IEC 60417; see [ordering examples 2 and 3](#)

For special symbols (order code Q9Y), a CAD drawing in BMP, GIF, JPEG, PDF, PNG or TIFF format must be submitted. For special inscriptions (order code Q9Y): document in DOC or XLS format.

The SIRIUS ACT Configurator must be used to select special inscriptions and symbols (order code Q9Y). In this case a "CIN" (Configuration Identification Number) is generated for placement of future orders. It is then possible to place an order directly using the CIN and the SIRIUS ACT Configurator (Mall shopping cart) or via the standard order channels.

Standard ordering channels:

- Configurator: [www.siemens.com/sirius-act/configurator](http://www.siemens.com/sirius-act/configurator)
- Electronic Catalog CA 01 on DVD
- Industry Mall: [www.usa.siemens.com/industrymall](http://www.usa.siemens.com/industrymall)

#### Ordering example 1

A label with 2 lines of text is required:

3SU1900-0AC16-0AZ0

Q1Y

Z1 = LIFT

Z2 = LOWER

#### Ordering example 2

A label inscribed with symbol No. 5011 according to IEC 60417 is required:

3SU1900-0AC16-0AZ0

Q3Y

Z = 5011 IEC

#### Ordering example 3

A label inscribed with symbol No. 1118 according to ISO 7000 is required:

3SU1900-0AC16-0AZ0

Q3Y

Z = 1118 ISO

# Push Button Units and Indicator Lights

## Labels

• Revised •  
08/31/15

### Labeling plates for enclosures

#### Overview

The labeling plates in size 22 mm x 22 mm can be attached to enclosures with cutouts for labels. There are versions in black with white print or silver-colored with black print.

#### Inscription

The inscription is in upper/lower case, all words begin with upper case letters. Graphic symbols, including those not listed in the catalog, are according to ISO 7000 or IEC 60417.

For customized inscription, see "Options" on page 10/134.

#### Selection and ordering data

Color	Marking	Symbol No.	DT	Order No.	PU (UNIT, SET, M)	PS*
<b>Labeling plates 22 mm x 22 mm</b>						
<b>For self-inscription</b>						
Black/White (label/lettering)	None	--	▶	<b>3SU1900-0AF16-0AA0</b>	100	10 units
	<b>For custom inscription</b>					
Black/White (label/lettering)	None	--	▶	<b>3SU1900-0AF16-0AZ0</b>	100	10 units
	<b>Inscription in English</b>					
Black/White (label/lettering)	On	--	B	<b>3SU1900-0AF16-0DJ0</b>	1	10 units
	Off	--	B	<b>3SU1900-0AF16-0DK0</b>	1	10 units
	Up	--	▶	<b>3SU1900-0AF16-0DL0</b>	1	10 units
	Down	--	▶	<b>3SU1900-0AF16-0DM0</b>	1	10 units
	Forward	--	B	<b>3SU1900-0AF16-0DN0</b>	1	10 units
	Right	--	B	<b>3SU1900-0AF16-0DQ0</b>	1	10 units
	Left	--	B	<b>3SU1900-0AF16-0DR0</b>	1	10 units
	Stop	--	▶	<b>3SU1900-0AF16-0DS0</b>	1	10 units
	Start	--	▶	<b>3SU1900-0AF16-0DT0</b>	1	10 units
	Reset	--	B	<b>3SU1900-0AF16-0DU0</b>	1	10 units
	Test	--	▶	<b>3SU1900-0AF16-0DV0</b>	1	10 units
	Open	--	B	<b>3SU1900-0AF16-0DW0</b>	1	10 units
	Close	--	B	<b>3SU1900-0AF16-0DX0</b>	1	10 units
	Running	--	B	<b>3SU1900-0AF16-0EB0</b>	1	10 units
	Fault	--	B	<b>3SU1900-0AF16-0EC0</b>	1	10 units
	Fast	--	B	<b>3SU1900-0AF16-0EE0</b>	1	10 units
Slow	--	B	<b>3SU1900-0AF16-0EF0</b>	1	10 units	
EMERGENCY STOP	--	▶	<b>3SU1900-0AF16-0DA0</b>	1	10 units	
<b>With symbol (ON/OFF)</b>						
Black/White (label/lettering)	O	5008 IEC	▶	<b>3SU1900-0AF16-0QA0</b>	1	10 units
	I	5007 IEC	▶	<b>3SU1900-0AF16-0QB0</b>	1	10 units
	II	--	▶	<b>3SU1900-0AF16-0QC0</b>	1	10 units
	III	--	B	<b>3SU1900-0AF16-0QD0</b>	1	10 units
	O I	--	B	<b>3SU1900-0AF16-0QG0</b>	1	10 units
	I O II	--	B	<b>3SU1900-0AF16-0QK0</b>	1	10 units
	I O	--	B	<b>3SU1900-0AF16-0QP0</b>	1	10 units
	(one below the other)					
	II O I	--	B	<b>3SU1900-0AF16-0QQ0</b>	1	10 units
	(one below the other)					
<b>With symbol (graphic)</b>						
Black/White (label/lettering)	→	ARROW DIRECTION TO RIGHT	5022 IEC	▶	<b>3SU1900-0AF16-0QR0</b>	1 10 units
		PUMP	0134 ISO	B	<b>3SU1900-0AF16-0RD0</b>	1 10 units
		FAN	--	B	<b>3SU1900-0AF16-0RV0</b>	1 10 units
		COOLING	--	B	<b>3SU1900-0AF16-0RW0</b>	1 10 units
		ILLUMINATION	--	B	<b>3SU1900-0AF16-0RX0</b>	1 10 units
		MOTOR	--	B	<b>3SU1900-0AF16-0RY0</b>	1 10 units

• Revised •  
08/31/15

# Push Button Units and Indicator Lights

Labels

## Labeling plates for enclosures

1  
2  
3  
4  
5  
6  
7  
8  
9  
10

### Labeling plates 22 mm x 22 mm

Color	Marking	Symbol No.	DT	Order No.	PU (UNIT, SET, M)	PS*
-------	---------	------------	----	-----------	-------------------------	-----



3SU1900-0AF81-0AA0

#### For self-inscription

Silver/Black (label/lettering) None -- A

#### For custom inscription

Silver/Black (label/lettering) None -- A

3SU1900-0AF81-0AA0

100 10 units

3SU1900-0AF81-0AZ0

100 10 units

#### Inscription in English

Silver/Black (label/lettering) Stop -- B  
Start -- B  
Reset -- B  
Test -- B  
Open -- B  
Hand O Auto -- B

3SU1900-0AF81-0DS0  
3SU1900-0AF81-0DT0  
3SU1900-0AF81-0DU0  
3SU1900-0AF81-0DV0  
3SU1900-0AF81-0DW0  
3SU1900-0AF81-0DD0

1 10 units  
1 10 units  
1 10 units  
1 10 units  
1 10 units  
1 10 units



3SU1900-0AF81-0DU0



3SU1900-0AF81-0DD0

#### With symbol (ON/OFF)

Silver/Black (label/lettering) O 5008 IEC B  
I 5007 IEC B  
II -- B  
III -- B  
O I -- B  
I O II -- B  
I O -- B  
(one below the other)  
II O I -- B  
(one below the other)

3SU1900-0AF81-0QA0  
3SU1900-0AF81-0QB0  
3SU1900-0AF81-0QC0  
3SU1900-0AF81-0QD0  
3SU1900-0AF81-0QG0  
3SU1900-0AF81-0QK0  
3SU1900-0AF81-0QP0  
3SU1900-0AF81-0QQ0

1 10 units  
1 10 units  
1 10 units  
1 10 units  
1 10 units  
1 10 units  
1 10 units  
1 10 units



3SU1900-0AF81-QK0

#### With symbol (graphic)

Silver/Black (label/lettering) → ARROW DIRECTION TO RIGHT 5022 IEC B

3SU1900-0AF81-0QR0

1 10 units

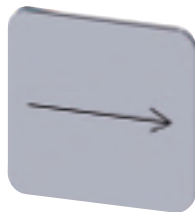

3SU1900-0AF81-0QR0

### Labeling plates for enclosures

#### Options

##### Customized inscriptions

The labels can be inscribed with texts and symbols not listed in the ordering data.

A letter height of 4 mm is used for text inscriptions (1 to 3 lines).

Up to 11 characters per line are possible. The typeface used is Arial. Other letter heights and typefaces are possible, but must be specified when ordering.

##### Examples for customized inscription

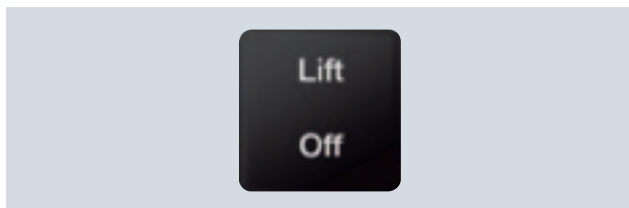

Two-line inscription in upper/lower case lettering (Q0Y)

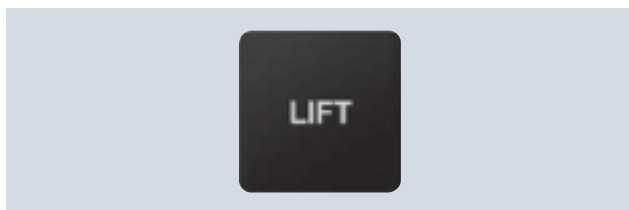

Single-line inscription in upper case lettering (Q1Y)

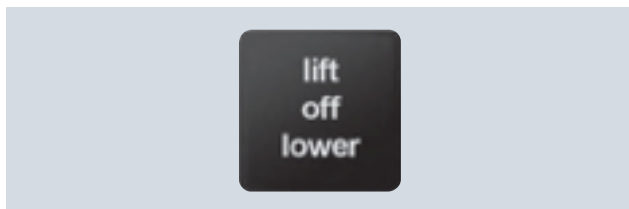

3SB39 backing plate for enclosures, customized inscription (Q2Y)



Symbol number 5011 according to IEC 60417 (Q3Y)

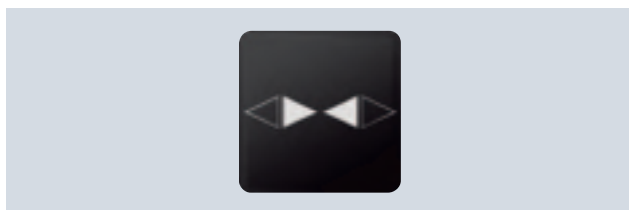

Any symbol according to order form supplement (Q9Y)

##### Ordering notes

Append the following order codes to the Order No.:

- Text line(s) in upper/lower case, upper case always for beginning of line (e.g. "Lift / Off"): **Q0Y**
- Text line(s) in upper case (e.g. "LIFT"): **Q1Y**
- Text line(s) in lower case (e.g. "lift / off / lower"): **Q2Y**
- Text line(s) in upper/lower case, all words begin with upper case letters (e.g. "On Off"): **Q5Y**
- Symbol with number according to ISO 7000 or IEC 60417: **Q3Y**
- Any inscription or symbol according to order form supplement: **Q9Y**

When ordering, specify the required inscription in plain text in addition to the article number and order code. In the case of special inscriptions with words in languages other than German, give the exact spelling and specify the language.

In the case of multi-line inscriptions, the text must be assigned to the respective line, e.g. "Z1 = Lift, Z2 = Lower". For long words you can also specify the end-of-line division (see ordering example 1).

Symbols can also be ordered with numbers according to ISO 7000 or IEC 60417 (see ordering examples 2 and 3).

For special symbols (order code Q9Y), a CAD drawing in DXF format can be submitted.

The SIRIUS ACT Configurator must be used to select special inscriptions and symbols (order code Q9Y). In this case a "CIN" (Configuration Identification Number) is generated for placement of future orders. It is then possible to place an order directly using the CIN and the SIRIUS ACT Configurator (Mall shopping cart) or via the standard order channels.

Standard ordering channels:

- Configurator: [www.siemens.com/sirius-act/configurator](http://www.siemens.com/sirius-act/configurator)
- Electronic Catalog CA 01 on DVD
- Industry Mall: [www.usa.siemens.com/industrymall](http://www.usa.siemens.com/industrymall)

##### Ordering example 1

A label with 2 lines of text is required:

3SU1900-0AF16-0AZ0  
Q1Y  
Z1 = LIFT  
Z2 = LOWER

##### Ordering example 2

A label inscribed with symbol No. 5011 according to IEC 60417 is required:

3SU1900-0AF16-0AZ0  
Q3Y  
Z = 5011 IEC

##### Ordering example 3

A label inscribed with symbol No. 1118 according to ISO 7000 is required:

3SU1900-0AF16-0AZ0  
Q3Y  
Z = 1118 ISO

### Overview

#### Label inscriptions



Using the *Label Designer* software, which can be downloaded from the Internet, and the labeling plates for laser inscription you can create your own customized labels with a standard laser printer. The self-adhesive or snap-on labels can be stuck or snapped onto the corresponding label holders. Round labels are provided for inserting in illuminated pushbuttons and switches.

The labels are suitable for inscription with one to three lines of text or symbols.

For applications with more exacting requirements we recommend factory-printed labeling plates and insert labels (laser-printed or engraved depending on the type).



For the *Label Designer* software see:  
[www.siemens.com/sirius-label-designer](http://www.siemens.com/sirius-label-designer)

### Selection and ordering data

	Fastening method	Height mm	Width mm	DT	Order No.	PU (UNIT, SET, M)	PS*
<b>Labels for printing - insert labels</b>							
	Insert	--	--	B	<b>3SU1900-0BH60-0AA0</b>	100	480 units
3SU1900-0BH60-0AA0							
<b>Labels for printing - labeling plates</b>							
	Self-adhesive	12.5	27.5	A	<b>3SU1900-0BJ61-0AA0</b>	100	480 units
		17.5	27	A	<b>3SU1900-0BK61-0AA0</b>	100	720 units
		27	27	A	<b>3SU1900-0BL61-0AA0</b>	100	480 units
		22	22	A	<b>3SU1900-0BM61-0AA0</b>	100	700 units
3SU1900-0BJ61-0AA0							

### Other labels

#### Selection and ordering data

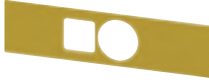
	Color	Fastening method	Outer diameter mm	Marking	DT	Order No.	PU (UNIT, SET, M)	PS*									
<b>EMERGENCY STOP backing plates</b>																	
	Yellow/Black (label/lettering)	None	45	None	A	<b>3SU1900-0BA31-0AA0</b>	1	10 units									
			75	None	A	<b>3SU1900-0BB31-0AA0</b>	1	10 units									
			75	EMERGENCY STOP	A	<b>3SU1900-0BB31-0DA0</b>	1	10 units									
<b>For Custom Inscription</b>																	
For inscription or symbol options refer to page 112																	
			45			<b>3SU1900-0AB31-0AZ0</b>											
			75			<b>3SU1900-0BB31-0AZ0</b>											
3SU1900-0BB31-0AA0																	
<b>EMERGENCY STOP backing plates</b>																	
	Yellow/Black (label/lettering)	Self- adhesive	75	None	▶	<b>3SU1900-0BC31-0AA0</b>	1	10 units									
				EMERGENCY STOP	▶	<b>3SU1900-0BC31-0DA0</b>	1	10 units									
3SU1900-0BC31-0DA0																	
				NOT-HALT, EMERGENCY STOP, EMERGENZA, EMERGENCIA (de, en, it, sp)	A	<b>3SU1900-0BC31-0NB0</b>	1	10 units									
				<b>For Custom Inscription</b>													
For inscription or symbol options refer to page 112																	
			75			<b>3SU1900-0BC31-0AZ0</b>											
3SU1900-0BC31-0NB0																	
<b>Labeling plates for potentiometers</b>																	
	Black/White (label/lettering)	None	40	--	A	<b>3SU1900-0BG16-0AA0</b>	1	10 units									
				SYMBOL: 0 ... 9	B	<b>3SU1900-0BG16-0RT0</b>	1	10 units									
				SYMBOL: Power up	B	<b>3SU1900-0BG16-0RU0</b>	1	10 units									
3SU1900-0BG16-0RU0																	
<table border="1"> <thead> <tr> <th>Color</th> <th>Label fastening method</th> <th>Height mm</th> <th>Width mm</th> <th>Marking</th> <th>DT</th> <th>Order No.</th> <th>PU (UNIT, SET, M)</th> <th>PS*</th> </tr> </thead> </table>									Color	Label fastening method	Height mm	Width mm	Marking	DT	Order No.	PU (UNIT, SET, M)	PS*
Color	Label fastening method	Height mm	Width mm	Marking	DT	Order No.	PU (UNIT, SET, M)	PS*									
<b>Labeling plates for enclosures with EMERGENCY STOP</b>																	
	Yellow/Black (label/lettering)	Self-adhesive	38	150	None	A	<b>3SU1900-0BE31-0AA0</b>	1 10 units									
3SU1900-0BE31-0AA0																	
<b>Labeling plates for enclosures with EMERGENCY STOP with recess</b>																	
	Yellow/Black (label/lettering)	Self-adhesive	38	150	None	B	<b>3SU1900-0BF31-0AA0</b>	1 10 units									
3SU1900-0BF31-0AA0																	
<b>Unit labeling plates</b>																	
	White/Black (label/lettering)	Insert	9.5	10.5	None	B	<b>3SU1900-0AY61-0AA0</b>	100 10 units									
3SU1900-0BY61-0AA0																	



## Options

### Customized inscriptions

The labels can be inscribed with text and symbols not listed in the ordering data.

The emergency stop backing plates are divided into four segments. Each segment can be customized individually. The letter height depends on the chosen number of characters and can be adjusted.

Example: Four segments of the emergency backing plate for customized inscription



### Ordering notes

Append the following order codes to the Order No.:

- Text line(s) in upper/lower case, upper case always for beginning of line (e.g. "Text"): **Q0Y**
- Text line(s) in upper case (e.g. "TEXT"): **Q1Y**
- Text line(s) in lower case (e.g. "text"): **Q2Y**
- Text line(s) in upper/lower case, all words begin with uppercase letters (e.g. "Text / Text"): **Q5Y**
- Symbol with number according to ISO 7000 or IEC 60417: **Q3Y**

When ordering, specify the required inscription in plain text in addition to the article number and order code. In the case of special inscriptions with words in languages other than English, give the exact spelling and specify the language. In the case of multi-line inscriptions, the text must be assigned to the respective line, e.g. "Z1 = Lift, Z2 =Lower". For long words you can also specify the end-of-line division (see [ordering example 1](#)).

Symbols can also be ordered with numbers according to ISO 7000 or IEC 60417; (see [ordering example 2](#)).

The SIRIUS ACT Configurator must be used to select customized inscriptions and symbols (order code **Q9Y**). In this case a "CIN" (Configuration Identification Number) is generated for placement of future orders. It is then possible to place an order directly using the CIN and the SIRIUS ACT Configurator (Mall shopping cart) or via the standard order channels.

Standard ordering channels:

- Configurator: [www.siemens.com/sirius-act/configurator](http://www.siemens.com/sirius-act/configurator)
- Electronic Catalog CA 01 on DVD
- Industry Mall: [www.usa.siemens.com/industrymall](http://www.usa.siemens.com/industrymall)

### Ordering example 1

A label with 2 lines of text is required:

**3SU1900-0BB31-0AZ0**

Q1Y

Z1=Text 1

Z2=Text 2

### Ordering example 2

A label inscribed with symbol No. 5638 according to IEC 60417 is required:

**3SU1900-0BB31-0AZ0**

Q3Y









Z=IEC5638

# Push Button Units and Indicator Lights Accessories

• Revised •  
08/31/15

## Protection/access protection

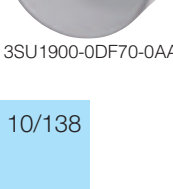
### Selection and ordering data

Product version	Material	Color	DT	Order No.	PU (UNIT, SET, M)	PS*	
<b>Protective caps</b>							
	<b>Sealable caps</b>	Plastic	Black	B	<b>3SU1900-0DA10-0AA0</b>	1	1 unit
			Clear	B	<b>3SU1900-0DA70-0AA0</b>	1	1 unit
3SU1900-0DA10-0AA0							
	<b>Sealable caps for pushbuttons</b>	Plastic	Black	B	<b>3SU1900-0EL10-0AA0</b>	1	1 unit
			Clear	B	<b>3SU1900-0EL70-0AA0</b>	1	1 unit
3SU1900-0EL70-0AA0							
	<b>Silicone protective caps for pushbuttons, flat</b>	Plastic	Clear	A	<b>3SU1900-0DB70-0AA0</b>	1	1 unit
				A	<b>3SU1900-0ED70-0AA0</b>	1	1 unit
3SU1900-0DB70-0AA0							
	<b>Silicone protective caps for pushbuttons, raised</b>	Plastic	Clear	A	<b>3SU1900-0DC70-0AA0</b>	1	1 unit
				A	<b>3SU1900-0EE70-0AA0</b>	1	1 unit
3SU1900-0DC70-0AA0							
	<b>Silicone-free protective caps for pushbuttons, raised</b>	Plastic	Clear	A	<b>3SU1900-0DD70-0AA0</b>	1	1 unit
				B	<b>3SU1900-0EF70-0AA0</b>	1	1 unit
3SU1900-0DD70-0AA0							
	<b>Silicone protective caps for selectors, short</b>	Plastic	Clear	B	<b>3SU1900-0DD70-0AA0</b>	1	1 unit
				B	<b>3SU1900-0EF70-0AA0</b>	1	1 unit
3SU1900-0DD70-0AA0							
	<b>Silicone-free protective caps for selectors, short</b>	Plastic	Clear	B	<b>3SU1900-0DE70-0AA0</b>	1	1 unit
				B	<b>3SU1900-0EG70-0AA0</b>	1	1 unit
3SU1900-0DE70-0AA0							
	<b>Silicone protective caps for mushroom pushbuttons 40 mm</b>	Plastic	Clear	B	<b>3SU1900-0DE70-0AA0</b>	1	1 unit
				B	<b>3SU1900-0DF70-0AA0</b>	1	1 unit
3SU1900-0DE70-0AA0							
	<b>Silicone-free protective caps for mushroom pushbuttons 40 mm</b>	Plastic	Clear	B	<b>3SU1900-0DF70-0AA0</b>	1	1 unit
				B	<b>3SU1900-0EH70-0AA0</b>	1	1 unit
3SU1900-0DF70-0AA0							

• Revised •  
08/31/15

# Push Button Units and Indicator Lights

## Accessories

### Protection/access protection

1

2

3

4

5





6

7

8

9







10

Product version	Material	Color	DT	Order No.	PU (UNIT, SET, M)	PS*
<b>Protective caps</b>						
	Silicone protective caps for twin pushbuttons, flat	Plastic	Clear	▶	<b>3SU1900-0DG70-0AA0</b>	1 1 unit
	Silicone protective caps for twin pushbuttons, raised	Plastic	Clear	B	<b>3SU1900-0DH70-0AA0</b>	1 1 unit
	Silicone-free protective caps for twin pushbuttons, raised	Plastic	Clear	B	<b>3SU1900-0EK70-0AA0</b>	1 1 unit
	Dust caps for key-operated switches	Plastic	Black	B	<b>3SU1900-0EB10-0AA0</b>	1 1 unit
<b>Protective collars</b>						
	Sun collars	Plastic	Black	B	<b>3SU1900-0DJ10-0AA0</b>	1 1 unit
	360° protective collars for pushbuttons and selectors, short	Plastic	Black	B	<b>3SU1900-0DW10-0AA0</b>	1 1 unit

# Push Button Units and Indicator Lights Accessories

• Revised •  
08/31/15

## Protection/access protection

Product version	Material	Color	DT	Order No.	PU (UNIT, SET, M)	PS*
<b>Protective collars</b>						
 3SU1950-0DK80-0AA0	360° protective collars for pushbuttons, visibility from the side	Metal	Silver	B	3SU1950-0DK80-0AA0	1 1 unit
 3SU1950-0DL80-0AA0	360° protective collars for mushroom pushbuttons 40 mm, visibility from the side	Metal	Silver	B	3SU1950-0DL80-0AA0	1 1 unit
 3SU1900-0DY30-0AA0	Protective collars for EMERGENCY STOP	Plastic	Yellow Silver	▶ ▶	3SU1900-0DY30-0AA0 3SU1900-0DY80-0AA0	1 1 unit 1 1 unit
 3SU1950-0DX30-0AA0	Protective collars for padlocks	Metal	Yellow Silver	B B	3SU1950-0DX30-0AA0 3SU1950-0DX80-0AA0	1 1 unit 1 1 unit
 3SU1900-0EA30-0AA0	360° protective collars for EMERGENCY STOP, SEMI-Industry	Plastic	Yellow	B	3SU1900-0EA30-0AA0	1 1 unit
 3SU1900-0EC10-0AA0	Protection for sensor switch	Plastic	Black	B	3SU1900-0EC10-0AA0	1 1 unit

• Revised •  
08/31/15

# Push Button Units and Indicator Lights

## Accessories

### Protection/access protection

1

2

3

4

5







6

7

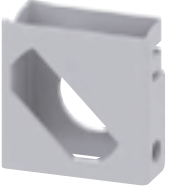
8

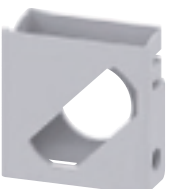
9

10



Product version	Material	Color	DT	Order No.	PU (UNIT, SET, M)	PS*
<b>Locking devices</b>						
	Metal	Silver	B	<b>3SU1950-0DM80-0AA0</b>	1	1 unit
<b>Locking devices for pushbuttons, raised</b>	Metal	Silver	B	<b>3SU1950-0DN80-0AA0</b>	1	1 unit
<b>Locking devices for mushroom pushbuttons D30, D40</b>	Metal	Silver	B	<b>3SU1950-0DP80-0AA0</b>	1	1 unit
3SU1950-0DM80-0AA0						
	Metal	Silver	B	<b>3SU1950-0DQ80-0AA0</b>	1	1 unit
<b>Locking devices for selectors short/long actuator, in the left position</b>						
3SU1950-0DQ80-0AA0						
	Metal	Silver	B	<b>3SU1950-0DR80-0AA0</b>	1	1 unit
<b>Locking devices for selectors short/long actuator, in the center position</b>						
3SU1950-0DR80-0AA0						
	Metal	Silver	B	<b>3SU1950-0DS80-0AA0</b>	1	1 unit
<b>Locking devices for selectors short/long actuator, in the right position</b>						
3SU1950-0DS80-0AA0						
	Metal	Silver	B	<b>3SU1950-0DT80-0AA0</b>	1	1 unit
<b>Locking devices for selectors short/long actuator, window from center to right, blocked on left</b>						
3SU1950-0DT80-0AA0						
	Metal	Silver	B	<b>3SU1950-0DU80-0AA0</b>	1	1 unit
<b>Locking devices for selectors short/long actuator, window from center to left, blocked on right</b>						
3SU1950-0DU80-0AA0						
	Metal	Silver	B	<b>3SU1950-0DV80-0AA0</b>	1	1 unit
<b>Covers for locking devices</b>						
3SU1950-0DV80-0AA0						

# Push Button Units and Indicator Lights Accessories



• Revised •  
08/31/15



## Actuators

### Selection and ordering data

	Material	Color	DT	Order No.	PU (UNIT, SET, M)	PS*
<b>Sealing plugs<sup>1)</sup></b>						
	Plastic	Black	▶	<b>3SU1900-0FA10-0AA0</b>	1	1 unit
3SU1900-0FA10-0AA0						
	Metal, matte	Sand gray	A	<b>3SU1930-0FA80-0AA0</b>	1	1 unit
	Metal, shiny	Silver	A	<b>3SU1950-0FA80-0AA0</b>	1	1 unit
3SU1950-0FA80-0AA0						

<sup>1)</sup> The sealing plug is mounted with a holder.  
Modules might already be mounted on the holder.

	Material	Color	DT	Order No.	PU (UNIT, SET, M)	PS*
<b>Buttons, flat</b>						
<b>For pushbuttons</b>						
	Plastic	Black	B	<b>3SU1900-0FT10-0AA0</b>	100	10 units
		Red	▶	<b>3SU1900-0FT20-0AA0</b>	100	10 units
		Yellow	B	<b>3SU1900-0FT30-0AA0</b>	100	10 units
		Green	▶	<b>3SU1900-0FT40-0AA0</b>	100	10 units
		Blue	B	<b>3SU1900-0FT50-0AA0</b>	100	10 units
		White	B	<b>3SU1900-0FT60-0AA0</b>	100	10 units
3SU1900-0FT20-0AA0						
<b>For illuminated pushbuttons</b>						
	Plastic	Amber	B	<b>3SU1901-0FT00-0AA0</b>	100	10 units
		Red	▶	<b>3SU1901-0FT20-0AA0</b>	100	10 units
		Yellow	B	<b>3SU1901-0FT30-0AA0</b>	100	10 units
		Green	▶	<b>3SU1901-0FT40-0AA0</b>	100	10 units
		Blue	B	<b>3SU1901-0FT50-0AA0</b>	100	10 units
		White	▶	<b>3SU1901-0FT60-0AA0</b>	100	10 units
		Clear	A	<b>3SU1901-0FT70-0AA0</b>	100	10 units
		3SU1901-0FT30-0AA0				

	Material	Color	DT	Order No.	PU (UNIT, SET, M)	PS*
<b>Buttons, raised</b>						
<b>For pushbuttons</b>						
	Plastic	Black	B	<b>3SU1900-0FS10-0AA0</b>	1	10 units
		Red	B	<b>3SU1900-0FS20-0AA0</b>	1	10 units
		Yellow	B	<b>3SU1900-0FS30-0AA0</b>	1	10 units
		Green	B	<b>3SU1900-0FS40-0AA0</b>	1	10 units
3SU1900-0FS30-0AA0						
<b>For illuminated pushbuttons</b>						
	Plastic	Red	▶	<b>3SU1901-0FS20-0AA0</b>	1	10 units
		Yellow	B	<b>3SU1901-0FS30-0AA0</b>	1	10 units
		Green	B	<b>3SU1901-0FS40-0AA0</b>	1	10 units
		Blue	B	<b>3SU1901-0FS50-0AA0</b>	1	10 units
		Clear	B	<b>3SU1901-0FS70-0AA0</b>	1	10 units
		3SU1901-0FS40-0AA0				

• Revised •  
08/31/15

# Push Button Units and Indicator Lights

## Accessories

### Actuators

1  
2  
3  
4  
5  
6  
7  
8  
9  
10

	Material	Key number	RFID coding version	Color	DT	Order No.	PU (UNIT, SET, M)	PS*
<b>Ronis keys</b>								
	Metal	SB30 455	--	Silver	▶ B	<b>3SU1950-0FB80-0AA0</b> <b>3SU1950-0FC80-0AA0</b>	1 1	1 unit 1 unit
3SSU1950-0FB80-0AA0								
<b>BKS keys</b>								
	Metal	S1	--	Silver	B	<b>3SU1950-0FD80-0AA0</b>	1	1 unit
3SSU1950-0FD80-0AA0								
<b>OMR keys</b>								
	Metal	73038 73037 73034 73033	--	Blue Red Black Yellow	B B B B	<b>3SU1950-0FJ50-0AA0</b> <b>3SU1950-0FK20-0AA0</b> <b>3SU1950-0FL10-0AA0</b> <b>3SU1950-0FM30-0AA0</b>	1 1 1 1	1 unit 1 unit 1 unit 1 unit
3SSU1950-0FJ50-0AA0								
<b>CES keys</b>								
	Metal	LSG1 SSG10 VL5	--	Silver	B A B	<b>3SU1950-0FN80-0AA0</b> <b>3SU1950-0FP80-0AA0</b> <b>3SU1950-0FQ80-0AA0</b>	1 1 1	1 unit 1 unit 1 unit
3SSU1950-0FP80-0AA0								
<b>IKON keys</b>								
	Metal	360012K1	--	Silver	B	<b>3SU1950-0FR80-0AA0</b>	1	1 unit
3SU1950-0FR80-0AA0								
<b>ID keys ID group individual</b>								
	Plastic	--	Individually coded, programmable several times	White	X	<b>3SU1900-0FU60-0AA0</b>	1	1 unit
3SU1900-0FU60-0AA0								
<b>ID keys</b>								
	Plastic	--	ID group 1 ID group 2 ID group 3 ID group 4	Green Yellow Red Blue	X X X X	<b>3SU1900-0FV40-0AA0</b> <b>3SU1900-0FW30-0AA0</b> <b>3SU1900-0FX20-0AA0</b> <b>3SU1900-0FY50-0AA0</b>	1 1 1 1	1 unit 1 unit 1 unit 1 unit
3SU1900-0FV40-0AA0								

# Push Button Units and Indicator Lights Accessories

• Revised •  
07/15/16

## Enclosures

### Selection and ordering data

Product version	Material	Color	DT	Order No.	PU (UNIT, SET, M)	PS*		
<b>Cable glands</b>								
 3SU1900-0HG10-0AA0	<b>Metric M20 cable glands</b> for enclosures		Plastic	Black	▶	<b>3SU1900-0HG10-0AA0</b>	1	1 unit
	<b>Metric M25 cable glands</b> for enclosures				B	<b>3SU1900-0HH10-0AA0</b>	1	1 unit
<b>For explosion protection (ATEX)</b> Ex category II 2D Ex tb IIIC T120 °C Db								
 3SU1900-0HG10-0AA1	<b>Metric M20 cable glands</b> for enclosures		Plastic	Black	B	<b>3SU1900-0HG10-0AA1</b>	1	1 unit
	<b>Metric M25 cable glands</b> for enclosures				B	<b>3SU1900-0HH10-0AA1</b>	1	1 unit
<b>Connection pieces</b>								
<b>For plastic enclosures</b>								
 3SU1900-0HJ10-0AA0	<b>M20/M20 connection pieces</b> for connecting 2 enclosures		Plastic	Black	B	<b>3SU1900-0HJ10-0AA0</b>	1	1 unit
	<b>M20/M25 connection pieces</b> for connecting 2 enclosures				B	<b>3SU1900-0HK10-0AA0</b>	1	1 unit
	<b>M25/M25 connection pieces</b> for connecting 2 enclosures				B	<b>3SU1900-0HL10-0AA0</b>	1	1 unit
<b>For metal enclosures</b>								
 3SU1950-0HJ10-0AA0	<b>M20/M20 connection pieces</b> for connecting 2 enclosures		Metal	Silver	B	<b>3SU1950-0HJ10-0AA0</b>	1	1 unit
	<b>M20/M25 connection pieces</b> for connecting 2 enclosures				B	<b>3SU1950-0HK10-0AA0</b>	1	1 unit
	<b>M25/M25 connection pieces</b> for connecting 2 enclosures				B	<b>3SU1950-0HL10-0AA0</b>	1	1 unit



• Revised •  
08/31/15

# Push Button Units and Indicator Lights

## Accessories

### Enclosures

1  
2  
3  
4  
5  
6  
7  
8  
9  
10

Product version	Material	Color	DT	Insulation piercing method		PU (UNIT, SET, M)	PS*
				Order No.			

#### Adapters for AS-i shaped cables



3SU1900-0HX10-0AA0

Insulation piercing method	Material	Color	DT	Insulation piercing method	PU (UNIT, SET, M)	PS*
M20	Plastic	Black	B	<b>3SU1900-0HX10-0AA0</b>	1	1 unit
M25			B	<b>3SU1900-0HY10-0AA0</b>	1	1 unit

#### Adapters

##### For plastic enclosures



3SU1930-0HS10-0AA0

M12 sockets, 4-pole	Material	Color	DT	Insulation piercing method	PU (UNIT, SET, M)	PS*
M20	Plastic	Black	B	<b>3SU1930-0HA10-0AA0</b>	1	1 unit
M25			B	<b>3SU1930-0HB10-0AA0</b>	1	1 unit
M12 connectors, 4-pole			B	<b>3SU1930-0HC10-0AA0</b>	1	1 unit
M20			B	<b>3SU1930-0HD10-0AA0</b>	1	1 unit
M25	Plastic	Black	B	<b>3SU1930-0HP10-0AA0</b>	1	1 unit
M12 sockets, 5-pole			B	<b>3SU1930-0HQ10-0AA0</b>	1	1 unit
M20			B	<b>3SU1930-0HR10-0AA0</b>	1	1 unit
M25			B	<b>3SU1930-0HS10-0AA0</b>	1	1 unit
M12 connectors, 5-pole	Plastic	Black	B	<b>3SU1930-0HT10-0AA0</b>	1	1 unit
M20			B	<b>3SU1930-0HU10-0AA0</b>	1	1 unit
M25			B	<b>3SU1930-0HV10-0AA0</b>	1	1 unit
M12 sockets, 8-pole			B	<b>3SU1930-0HW10-0AA0</b>	1	1 unit
M20	Plastic	Black	B	<b>3SU1930-0HT10-0AA0</b>	1	1 unit
M25			B	<b>3SU1930-0HU10-0AA0</b>	1	1 unit
M12 connectors, 8-pole			B	<b>3SU1930-0HV10-0AA0</b>	1	1 unit
M20			B	<b>3SU1930-0HW10-0AA0</b>	1	1 unit
M25	Metal	Black	B	<b>3SU1950-0HA10-0AA0</b>	1	1 unit
M12 sockets, 4-pole			B	<b>3SU1950-0HB10-0AA0</b>	1	1 unit
M20	Metal	Black	B	<b>3SU1950-0HC10-0AA0</b>	1	1 unit
M25			B	<b>3SU1950-0HD10-0AA0</b>	1	1 unit
M12 connectors, 4-pole			B	<b>3SU1950-0HE10-0AA0</b>	1	1 unit
M20			B	<b>3SU1950-0HF10-0AA0</b>	1	1 unit
M25	Metal	Black	B	<b>3SU1950-0HP10-0AA0</b>	1	1 unit
M12 sockets, 5-pole			B	<b>3SU1950-0HQ10-0AA0</b>	1	1 unit
M20			B	<b>3SU1950-0HR10-0AA0</b>	1	1 unit
M25			B	<b>3SU1950-0HS10-0AA0</b>	1	1 unit
M12 connectors, 5-pole	Metal	Black	B	<b>3SU1950-0HT10-0AA0</b>	1	1 unit
M20			B	<b>3SU1950-0HU10-0AA0</b>	1	1 unit
M25			B	<b>3SU1950-0HV10-0AA0</b>	1	1 unit
M12 sockets, 8-pole			B	<b>3SU1950-0HW10-0AA0</b>	1	1 unit
M20	Metal	Black	B	<b>3SU1950-0HT10-0AA0</b>	1	1 unit
M25			B	<b>3SU1950-0HU10-0AA0</b>	1	1 unit
M12 connectors, 8-pole			B	<b>3SU1950-0HV10-0AA0</b>	1	1 unit
M20			B	<b>3SU1950-0HW10-0AA0</b>	1	1 unit
M25	Plastic	Black	B	<b>3SU1900-0HM10-0AA0</b>	1	1 unit
M12 sockets, 4-pole			B	<b>3SU1900-0HM10-0AA0</b>	1	1 unit
M20	Metal	Black	B	<b>3SU1950-0HA10-0AA0</b>	1	1 unit
M25			B	<b>3SU1950-0HB10-0AA0</b>	1	1 unit
M12 connectors, 4-pole			B	<b>3SU1950-0HC10-0AA0</b>	1	1 unit
M20			B	<b>3SU1950-0HD10-0AA0</b>	1	1 unit
M25	Metal	Black	B	<b>3SU1950-0HP10-0AA0</b>	1	1 unit
M12 sockets, 5-pole			B	<b>3SU1950-0HQ10-0AA0</b>	1	1 unit
M20			B	<b>3SU1950-0HR10-0AA0</b>	1	1 unit
M25			B	<b>3SU1950-0HS10-0AA0</b>	1	1 unit
M12 connectors, 5-pole	Metal	Black	B	<b>3SU1950-0HT10-0AA0</b>	1	1 unit
M20			B	<b>3SU1950-0HU10-0AA0</b>	1	1 unit
M25			B	<b>3SU1950-0HV10-0AA0</b>	1	1 unit
M12 sockets, 8-pole			B	<b>3SU1950-0HW10-0AA0</b>	1	1 unit
M20	Metal	Black	B	<b>3SU1950-0HT10-0AA0</b>	1	1 unit
M25			B	<b>3SU1950-0HU10-0AA0</b>	1	1 unit
M12 connectors, 8-pole			B	<b>3SU1950-0HV10-0AA0</b>	1	1 unit
M20			B	<b>3SU1950-0HW10-0AA0</b>	1	1 unit
M25	Plastic	Black	B	<b>3SU1900-0HM10-0AA0</b>	1	1 unit
M12 sockets, 4-pole			B	<b>3SU1900-0HM10-0AA0</b>	1	1 unit



3SU1950-0HA10-0AA0

##### For metal enclosures

#### Enclosure cover monitoring



3SU1900-0HM10-0AA0

Enclosure cover monitoring (module with extension plunger)	Material	Color	DT	Insulation piercing method	PU (UNIT, SET, M)	PS*
	Plastic	Black	B	<b>3SU1900-0HM10-0AA0</b>	1	1 unit

# Push Button Units and Indicator Lights Accessories

• Revised •  
07/15/16

## Miscellaneous accessories

### Selection and ordering data

Product version	Material	Color	DT	Order No.	PU (UNIT, SET, M)	PS*
<b>Accessories</b>						
 3SU1900-0KA10-0AA0	<b>PCB carriers</b>	Plastic	Black	▶	<b>3SU1900-0KA10-0AA0</b>	1 10 units
 3SU1900-0KC10-0AA0	<b>Pressure plates for selectors and locks</b>	Plastic	White	▶	<b>3SU1900-0KC10-0AA0</b>	1 10 units
 3SU1900-0KD10-0AA0	<b>Connection kits, standard slave</b>	Plastic	Black	B	<b>3SU1900-0KD10-0AA0</b>	1 1 unit
	<b>ASI-F-slave</b>	Plastic	Black	B	<b>3SU1900-0KE10-0AA0</b>	1 1 unit
 3SU1900-0KF10-0AA0	<b>Drilling template for 30 x 40 grid, horizontal</b>	Plastic	Black	B	<b>3SU1900-0KF10-0AA0</b>	1 1 unit
 3SU1900-0KG10-0AA0	<b>Extension plungers</b> For compensation of the distance between the pushbutton and the unlatching button of an overload relay	Plastic	Black	A	<b>3SU1900-0KG10-0AA0</b>	1 1 unit
 3SU1900-0KH80-0AA0	<b>Adapters for standard rail mounting</b>	Plastic	Silver	▶	<b>3SU1900-0KH80-0AA0</b>	1 1 unit
 3SU1950-0KJ80-0AA0	Adapters for actuators and indicators with front ring for flat mounting	Metal	Silver	A	<b>3SU1950-0KJ80-0AA0</b>	1 1 unit
	Adapters for mounting hole 30.5 mm For mounting 22.5 mm pushbuttons and indicator lights	Metal	Silver	▶	<b>3SU1950-0KB10-0AA0</b>	1 1 unit
 3SU1950-0KK80-0AA0	Grounding studs	Metal	Silver	B	<b>3SU1950-0KK80-0AA0</b>	100 50 units
 3SU1900-0KL10-0AA0	Connectors for sensor switches	Metal	Black	B	<b>3SU1900-0KL10-0AA0</b>	100 50 units

## Standards and approvals

- 1
- 2
- 3
- 4
- 5
- 6
- 7
- 8
- 9
- 10

### Approvals, test certificates, characteristic curves

An overview of the certificates available for Industrial Control products along with more technical documentation can be consulted daily on the Internet at:

[www.siemens.com/sirius/approvals](http://www.siemens.com/sirius/approvals)



Product support: Approvals/certificates



Product support: Characteristics

### Safety characteristics

In the following standards, the so-called B10 values for calculating the safety integrity or safety integrity level (SIL) in functional safety at a high or continuous demand rate are required also for electromechanical switchgear:

- IEC 62061 "Safety of machines – Functional safety of safety-related electrical, electronic and programmable electronic control systems";
- ISO 13849-1 "Safety of machines – Safety-related components of controls – Part 1: General principles".

Failure rates of electromechanical components are required for calculating the safety integrity or safety integrity level (SIL) in functional safety:

- in the manufacturing industry at a high demand rate
- in the process industry at a low demand rate

Further requirements are laid down in IEC 61511-1 "Functional safety – Safety instrumented systems for the process industry sector – Part 1: Framework, definitions, system, hardware and software requirements".

The German versions of the above standards are:

- EN 62061 (VDE 0113-50), 2005 + AMD 1:2013, which since 31.12.2005 has been harmonized as EN 62061 under the Machinery Directive
- EN ISO 13849-1:2008
- EN 61511-1 (VDE 810-1)

The TÜV-tested Safety Evaluation Tool assists in calculating the safety function as verification for the machine documentation. It is available on the Internet at

[www.siemens.com/safety-evaluation-tool](http://www.siemens.com/safety-evaluation-tool).

At [www.siemens.com/safety-integrated](http://www.siemens.com/safety-integrated) you will also find examples of functions with calculations according to the current standards.

#### Definitions

$\lambda(t) dt$  is the probability that a unit which has not failed by a certain time  $t$  will fail in the following interval  $(t; t + dt)$ . Failure rates have the dimension 1/time unit, e.g. 1/h. Failure rates for components are often specified in FIT (failures in time unit): 1 FIT equals  $10^{-9}/h$ .

From the failure rate it is possible to derive a (mathematical) distribution function of the failure probability:

$$F(t) = 1 - \exp(-\lambda t), \text{ with } \lambda \text{ as constant failure rate}$$

- The mean value of this exponential distribution is also referred to as:
  - Mean Time To Failure (MTTF) in the case of irreparable components; 63.2 % of components fail by the MTTF.
  - Mean Operating Time Between Failures (MTBF) in the case of repairable components.
- $MTTF = 1/\lambda$   
(MTTF is a statistical mean value but no guarantee for endurance)

Electromechanical components are often irreparable components. In general, the failure rate of monitored units changes with age.

## Standards and approvals

The B10 value for devices subject to wear is expressed in number of operating cycles:

- it is the number of operating cycles after which 10 % of the test specimens fail in the course of an endurance test (or: the number of operating cycles after which 10 % of the devices have failed).

For low demand rates (mainly in the process industry), the failure rate and not the B10 value is used to determine the failure probability.

### Standard B10 values at a high demand rate

With the help of the B10 value and a simplified formula (see section 6.7.8.2.1 of EN 62061), the user can then calculate the total failure rate of an electromechanical component:

$$\lambda = 0.1 \times C/B10$$

with C = operating cycles per hour. C is specified by the user.

The failure rate is made up of safe ( $\lambda_S$ ) and dangerous ( $\lambda_D$ ) failures:

$$\lambda = \lambda_S + \lambda_D$$

or

$$\lambda_D = [\text{share of dangerous failures in \%}] \times \lambda$$

$$\lambda_S = [\text{share of safe failures in \%}] \times \lambda$$

The failure rate of the dangerous failures  $\lambda_D$  of the components used is needed for further calculations.

Listed in the following table are the standard B10 values and the share of dangerous failures for SIRIUS product groups at a high demand rate.

Standard B10 values (at a high demand rate)		
SIRIUS ACT product group (electromechanical components)	Standard B10 value <sup>1)</sup> (operating cycles)	Share of dangerous failures
3SU1 EMERGENCY-STOP mushroom pushbuttons (with positive-opening contacts)	100 000	20 %
3SU1 pushbuttons (non-latching, with positive-opening contacts)	10 000 000	20 %

<sup>1)</sup> Only applies under the conditions specified in the technical specifications.

The B10<sub>d</sub> value used in EN ISO 13849-1:2008 is determined as follows:

$$B10_d = \frac{B10}{\text{Share of dangerous failures}}$$

### Calculation example

A protective door is monitored by a position switch with a separate actuator.

The protective door is opened 4 times an hour.

The overall failure rate of the position switch is:

$$\lambda = 0.1 \cdot C/B10 \text{ [failures/h]}$$

$$\lambda = 0.1 \cdot 4/1000000 = 4 \cdot 10^{-7} \text{ [failures/h]}$$

The dangerous failure rate is calculated with:

$$\lambda_D = 20 \% \text{ of } \lambda = 0.2 \cdot 4 \cdot 10^{-7} \text{ [failures/h]}$$

$$\lambda_D = 8 \cdot 10^{-8} \text{ [failures/h]}$$

### Standard failure rates (at a low demand rate)

On the basis of the failure rates, it is possible to calculate the average probability of failure on demand (PFD<sub>avg</sub>) of a PLT protective device.

A so-called low demand rate is assumed, meaning the rate of demand on the safety-related system amounts to no more than once a year and is not greater than double the frequency of the repeat test.

A repeat test once a year is recommended for electromechanical components in order to reveal passive faults.

For special applications it is possible, in agreement with the inspecting institution (e.g. a technical inspectorate, government agency or the like) to extend the test intervals by using suitable solutions (e.g. a multi-channel version etc.).

Listed in the following table are the standard failure rates and the share of dangerous failures for SIRIUS product groups at a low demand rate.

Standard failure rates at a low demand rate		
SIRIUS ACT product group (electromechanical components)	Standard failure rates (in FIT) <sup>1)</sup>	Share of dangerous failures
3SU1 EMERGENCY-STOP mushroom pushbuttons (with positive-opening contacts)	100	20 %
3SU1 pushbuttons (non-latching, with positive-opening contacts)	100	20 %

<sup>1)</sup> The failure rates specified in the table were limited to 100 FIT.

# Push Button Units and Indicator Lights

## 3SE2, 3SE3 Foot Switches

### Plastic and metal enclosures

1

2

3

4

5

6

7

8

9

10

### Overview

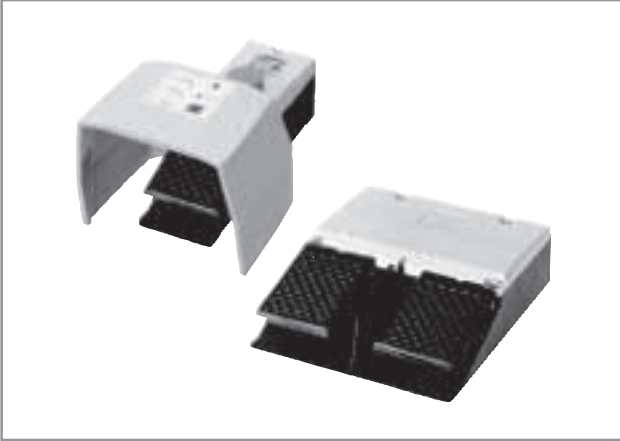

Foot switches with metal enclosures

### Standard switches

The 3SE2 9 and 3SE3 9 foot switch range encompasses versions in a metal enclosure for rugged applications as well as versions with plastic enclosure for less harsh environments. The devices can be supplied with or without a cover and have fixing holes for them to be screwed to the floor.

Depending on the particular application, the metal enclosures can be ordered in latching or momentary-contact versions. The momentary-contact pedal switch in the plastic enclosure has one microswitch (changeover contact) per actuating pedal.

### Safety foot switches

The 3SE2 924-3AA20 single-pedal safety foot switches are used on machines and plants as OK switches when operation by hand is not possible and the EMERGENCY-STOP function must be available if a hazardous status arises. The switches are interlocked according to EN ISO 13850 and bear the CE mark in accordance with the machinery directive.

The safety foot switches are protected by a guard hood against accidental operation.

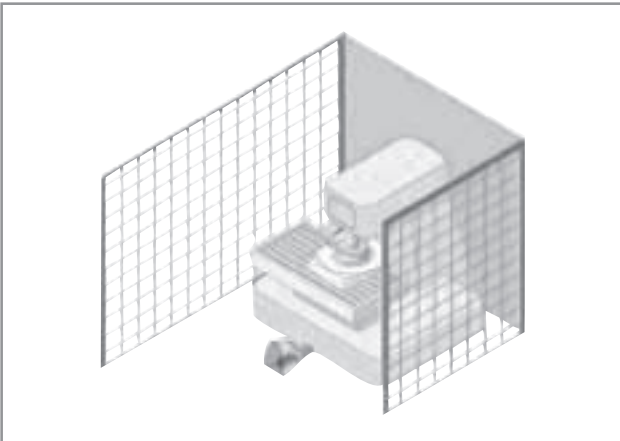

Application example

The switches have two contact blocks, each with one NO contact and one NC contact. The NO contacts and NC contacts of the two contact blocks are connected for easy connection of a single-phase motor. The normal workflow is initiated by pressing down the pedal as far as the pressure point so that the two NO contacts close and the motor starts to run.

If in the event of danger the pedal is pressed beyond the resistance of the pressure point, the positively driven NC contacts will open and the motor is stopped. At the same time the independent latching takes effect and holds the NC contacts in open position. This prevents the machine parts from continuing to run out of control or from being restarted.

After the hazard is eliminated, the machine can only be restarted after manually releasing the switch using a push button on the top of the enclosure. The contacts are then released again and return to their initial position (the NO contacts are open and the NC contacts are closed).

### Technical specifications













Type	3SE29	3SE39
<b>Metal and plastic enclosures</b>		
<b>Standards</b>	IEC 60947-5-1	
<b>Electrical load</b>		
• At AC-15, 400 V		
- 1 NO + 1 NC	A 16	—
- 2 NO + 2 NC	A 6	—
- 3SE2 924-3AA20 (2 NO + 2 NC)	A 16	—
• At 250 V AC	A —	5
<b>Short-circuit protection</b>		
- 1 NO + 1 NC / 3SE2 924-3AA20	A 16 (slow)	—
- 2 NO + 2 NC	A 6 (slow)	—
- 1 CO contact	A —	5 (slow)
<b>Mechanical endurance</b>	> 10 <sup>6</sup> operating cycles	
<b>Material</b>		
• Enclosures	Aluminum casting	Impact-resistant thermoplast, self-extinguishing according to UL 94 VO
• Covers	Thermoplast	—
• Guard hoods	Aluminum casting	Metal
<b>Degree of protection</b>	IP65	IP65
<b>Ambient temperature</b>	°C -25 ... +80	-10 ... +75
<b>Connection</b>	Cable entry, metric	Cable AWG20, UL Style 2464, length 3 m

# Push Button Units and Indicator Lights

## 3SE2, 3SE3 Foot Switches

### Plastic and metal enclosures

#### Selection and ordering data

Version	Slow-action contacts for each pedal	DT	Order No.	PU (UNIT, SET, M)	PS		
<b>Metal enclosures, degree of protection IP65</b>							
 <p>3SE2 90.-AA20 3SE2 91.-AA20</p>	<b>Momentary-contact foot switches, single pedal</b> M20 x 1.5 cable entry						
	<ul style="list-style-type: none"> <li>Without hood</li> </ul>	1 NO + 1 NC  A 2 NO + 2 NC  A	A A	<b>3SE2 902-0AB20</b>  <b>3SE2 903-1AB20</b>	1 1	1 unit 1 unit	
	<ul style="list-style-type: none"> <li>With hood</li> </ul>	1 NO + 1 NC  A 2 NO + 2 NC  A	A A	<b>3SE2 902-0AA20</b>  <b>3SE2 903-1AA20</b>	1 1	1 unit 1 unit	
 <p>3SE2 932-AB20</p>	<b>Momentary-contact foot switches, single pedal</b> M20 x 1.5 cable entry						
	<ul style="list-style-type: none"> <li>Without hood</li> </ul>	1 NO + 1 NC  C	C	<b>3SE2 912-2AB20</b>	1	1 unit	
	<ul style="list-style-type: none"> <li>With hood</li> </ul>	1 NO + 1 NC  C	C	<b>3SE2 912-2AA20</b>	1	1 unit	
 <p>3SE2 932-AA20</p>	<b>Momentary-contact foot switches, two pedals</b> M25 x 1.5 cable entry						
	<ul style="list-style-type: none"> <li>Without hood</li> </ul>	1 NO + 1 NC  B 2 NO + 2 NC  B	B B	<b>3SE2 932-0AB20</b>  <b>3SE2 932-1AB20</b>	1 1	1 unit 1 unit	
	<ul style="list-style-type: none"> <li>With hood</li> </ul>	1 NO + 1 NC  B 2 NO + 2 NC  B	B B	<b>3SE2 932-0AA20</b>  <b>3SE2 932-1AA20</b>	1 1	1 unit 1 unit	
 <p>3SE2 924-3AA20</p>	<b>Safety foot switches, single pedal, with hood,</b> M20 x 1.5 cable entry, with interlock according to ISO 13850, NO closes as momentary contact type, NC opens with latching		2 NO + 2 NC  C	C	<b>3SE2 924-3AA20</b>	1	1 unit
<b>Plastic enclosures, degree of protection IP65</b>							
 <p>3SE3 902-4CA20</p>	<b>Momentary-contact pedal switches, 3 m cable</b>						
	<ul style="list-style-type: none"> <li>Single pedal</li> <li>- Without hood</li> </ul>	1 CO contact	B	<b>3SE3 902-4CB20</b>	1	1 unit	
	<ul style="list-style-type: none"> <li>- With hood</li> </ul>	1 CO contact	B	<b>3SE3 902-4CA20</b>	1	1 unit	
 <p>3SE3 934-5CB20</p>	<ul style="list-style-type: none"> <li>Two pedals, without hood</li> </ul>	2 x 1 CO	B	<b>3SE3 934-5CB20</b>	1	1 unit	

 Positive opening according to IEC 60947-5-1, Appendix K.



### Overview

The 8WD4 signaling columns are flexible in design and versatile in use.

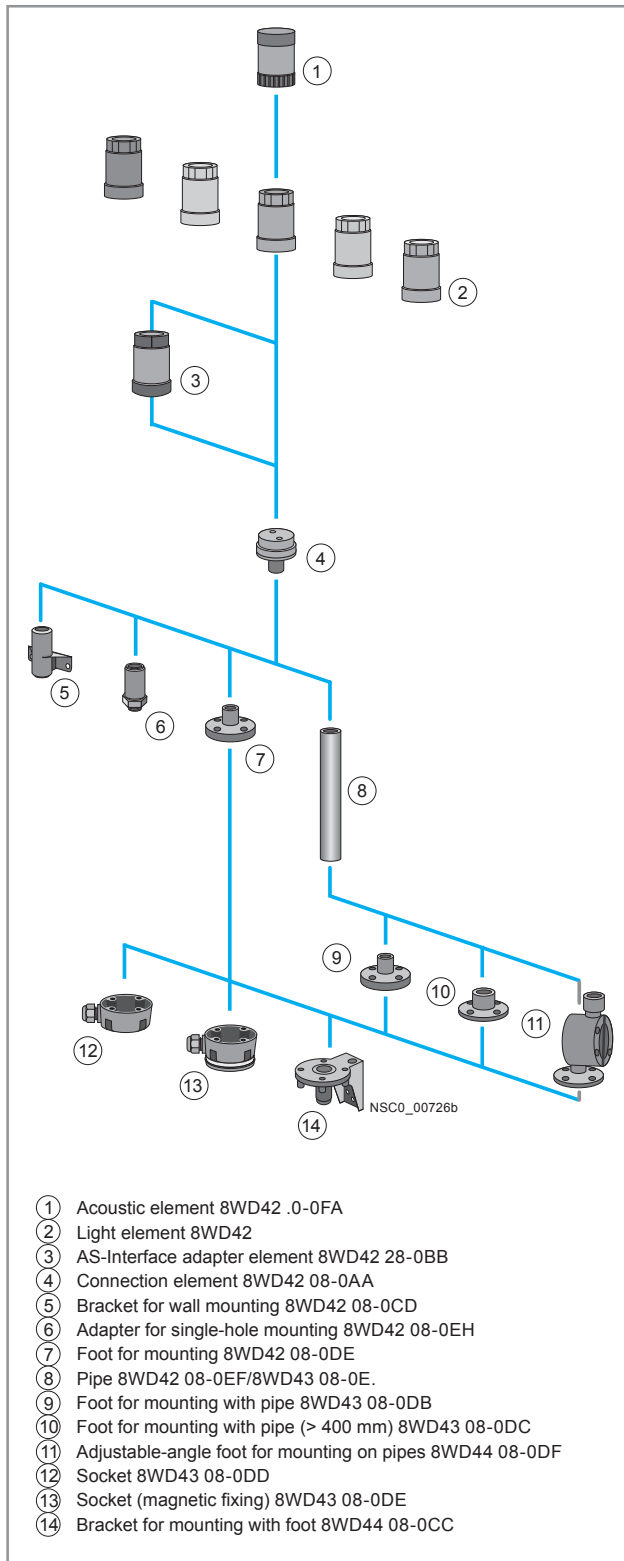

8WD42 signaling columns (width 50 mm) with up to 4 elements

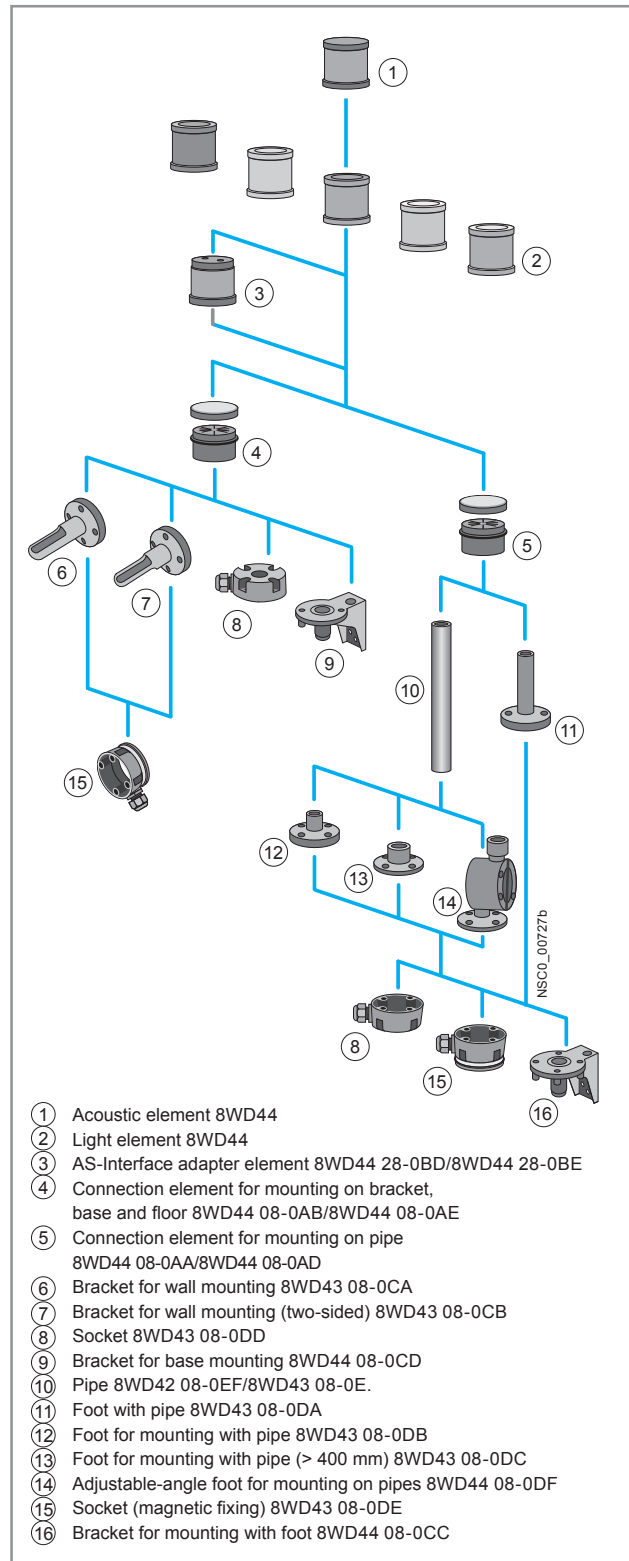

8WD44 signaling columns (width 70 mm) with up to 5 elements

# Push Button Units and Indicator Lights

## 8WD4 Signaling Columns

### General Data

Two product series are available:

- 8WD42
  - Thermoplast enclosure, diameter 50 mm
  - Degree of protection IP54
  - Up to 4 elements can be mounted between the connection element and the cover
- 8WD44
  - Thermoplast enclosure, diameter 70 mm
  - Advanced design and significantly improved illumination
  - Faster and more flexible connection using spring-type terminals
  - Integrated degree of protection IP65
  - Up to 5 elements can be mounted between the connection element and the cover



Signaling columns, mounting examples

The illustrated examples are from the left:

- 8WD42: Cover (no No.), 4 light elements ②, connection element ④, pipe ⑧, foot ⑨
- 8WD44: Acoustic element with integral cover ①, 2 light elements ②, connection element ⑤, foot with pipe ⑪
- 8WD44: Cover (no No.), 4 light elements ②, AS-Interface adapter element ③, connection element ④, bracket for wall mounting ⑥
- 8WD44: Cover (no No.), 3 light elements ②, AS-Interface adapter element ③, connection element ⑤, foot with pipe ⑪

#### Note:

The cover is supplied with the connection element; it is not needed with the acoustic element.

### Benefits

- Choice of various light and acoustic elements with different functions: continuous light, blinklight, flashlight and rotating light; buzzer and siren
- Light elements with particularly long-lasting LEDs
- Variety of colors: red, yellow, green, white or blue
- Optimized illumination through improved prism technology with the 8WD44
- Acoustic elements can be adjusted in tone and volume
- Extremely resistant to shock and vibrations
- Easy connection and quick lamp change with secure bayonet mechanism
- Communication capability through connection to AS-Interface

### Application

8WD4 signaling columns are used in machines or in automatic processes for monitoring complex procedures or as visual or acoustic warning devices in emergency situations, e.g. for displaying individual assembly stages.

#### Communication capability

##### Connection to AS-Interface

The 8WD4 signaling columns can be directly connected to the AS-Interface bus system through an adapter element that can be integrated in the column. Wiring outlay is reduced as the result. The two-wire bus cable is fixed to the terminals in the connection element. Up to four signaling elements can be mounted on it using an adapter element.

A/B technology enables the connection of up to 62 slaves on one AS-Interface system.

#### Connection

The signaling elements are wired up using the screw terminals in the connection element, screw terminals on the 8WD42 and screw or spring-type terminals on the 8WD44.

#### Cable outlet

The connecting cables can be guided either downwards or sideways through the cable gland using an adapter that can be screwed under the foot. This makes wiring easier if there is no access from below.

#### Connection to AS-Interface



#### 8WD42:

The two-wire bus cable is fixed to the screw terminals in the connection element. The adapter element must be the first module to be mounted on the connection element. A maximum of 4 signaling elements can then be mounted on it.

The adapter element 8WD42 28-0BB is a standard slave.

#### 8WD44:

The two-wire bus cable is fixed to the screw or spring-type terminals in the connection element. The adapter element must be the first module to be mounted on the connection element. The signaling elements can then be mounted on it.

The adapter element 8WD44 28-0BE is a standard slave. A maximum of 4 signaling elements can be mounted on it.

The adapter element 8WD44 28-0BD with A/B technology enables the connection of up to 62 slaves on one AS-Interface system. The addressing socket provides user-friendly parameterization of the AS-Interface elements. A maximum of 3 signaling elements can be mounted on it.



# Push Button Units and Indicator Lights

## 8WD4 Signaling Columns

### General Data

1  
2  
3  
4  
5  
6  
7  
8  
9  
10

#### Technical specifications

Type	8WD42	8WD44
<b>General data</b>		
<b>Approvals</b>	UL, CSA	UL, CSA
<b>Light and acoustic elements</b>		
<b>Rated voltage, power consumption</b>		
Light elements with incandescent lamp	(AC values for 50/60 Hz)	(AC values for 50/60 Hz)
• Continuous light	12 V, 24 V, 115 V, 230 V AC/DC	12 V, 24 V, 115 V, 230 V AC/DC
• Blinklight	24 V AC/DC/125 mA; 115 V AC/20 mA; 230 V AC/15 mA	24 V AC/DC/125 mA; 115 V AC/20 mA; 230 V AC/15 mA
• Flashlights	—	24 V DC/125 mA; 115 V AC/20 mA; 230 V AC/35 mA
• Max. inrush current, blinklight/flashlight	—	500 mA
Light elements with integrated LED		
• Continuous light	24 V AC/DC/60 mA	24 V AC/DC/45 mA; 115 V AC/DC/25 mA; 230 V AC/25 mA
• Blinklight	—	24 V AC/DC/40 mA
• Rotating light	—	24 V AC/DC/70 mA
Acoustic elements		
• Buzzer element (tone: pulsating or continuous, 85 dB)	24 V AC/DC/25 mA; 115 V AC/DC/25 mA; 230 V AC/25 mA	24 V AC/DC/25 mA; 115 V AC/DC/25 mA; 230 V AC/25 mA
• Siren element (8 tones + amplification can be set, 100 dB)	—	24 V AC/DC/80 mA; 115 V AC/30 mA; 230 V AC/16 mA
• Siren element (108 dB)	—	24 V DC/100 mA
<b>Power consumption</b>		
• Incandescent lamps, base BA 15d	W max. 5	7
• Flashlight, flash energy	Ws —	2
<b>Endurance</b>		
• Flashlights	4 x 10 <sup>6</sup> flashes	4 x 10 <sup>6</sup> flashes
<b>AS-Interface adapter elements</b>		
<b>IO code/ID code</b>	8/F	8/E
<b>Power supply</b>		
• Operational voltage	V 18.5 ... 31.6	Through bus cable 18.5 ... 31.6
• Power consumption $I_{max}$	mA 50	100
<b>Protective measures</b>		
• Watchdog	✓	✓
• Short-circuit/overload protection	External back-up fuse M 1.6 A	✓
• Reverse polarity protection	✓	✓
• Induction protection	N/A	✓
<b>Outputs</b>		
• Load voltage	V 4 Relay outputs External auxiliary voltage 0 ... 30 DC 0 ... 230 AC	3 solid-state outputs through bus cable or external auxiliary voltage, switch-selectable
• Current carrying capacity $\Sigma I_{max}$		
- With external auxiliary voltage	A 1.5	0.3
- Without external auxiliary voltage	A —	0.2
<b>Operating temperature</b>	°C -20 ... +50	-20 ... +50
<b>Enclosures</b>		
<b>Enclosure material</b>	Thermoplast (polyamide), impact-resistant, black	Thermoplast (polyamide), impact-resistant, black
<b>Light elements</b>	Thermoplast (polycarbonate)	Thermoplast (polycarbonate)
<b>Mounting</b>		
• Horizontal (floor mounting, foot with 25 mm Ø pipe)	✓	✓
• Horizontal (single-hole mounting)	✓	—
• Vertical with bracket	✓	✓
<b>Degree of protection</b>		
• Light elements	IP54	IP65 (seal premounted with every module)
• Acoustic elements, AS-i adapter elements	IP54	IP65
<b>Operating temperature</b>	°C -20 ... +50	-20 ... +50
<b>Connection</b>		
• Conductor cross-sections	mm <sup>2</sup> M3 screw terminal Max. 2.5	Spring-type terminals/M3 screw terminals Max. 2.5
• Tightening torque	Nm Max. 0.5	- / Max. 0.5

# Push Button Units and Indicator Lights

## 8WD4 Signaling Columns

### 8WD42 signaling columns, 50 mm diameter

#### Overview

Features:

- Thermoplast enclosure, diameter 50 mm
- Degree of protection IP54
- Up to 4 elements can be mounted

#### Selection and ordering data

Version	Rated voltage	Color	DT	Order No.	PU (UNIT, SET, M)	PS	PG
V							
<b>Acoustic elements<sup>1)</sup></b>							
	<b>Buzzer elements</b> 80 dB, pulsating or continuous tone, adjustable by means of a wire jumper	24 AC/DC	Black	A	<b>8WD42 20-0FA</b>	1	1 unit 41J
		115 AC		A	<b>8WD42 40-0FA</b>	1	1 unit 41J
		230 AC		A	<b>8WD42 50-0FA</b>	1	1 unit 41J
<b>Light elements for incandescent lamps/LEDs, BA 15d bases<sup>2)</sup></b>							
	<b>Continuous light elements</b>	24 ... 230 AC/DC	Red	A	<b>8WD42 00-1AB</b>	1	1 unit 41J
			Green	A	<b>8WD42 00-1AC</b>	1	1 unit 41J
			Yellow	A	<b>8WD42 00-1AD</b>	1	1 unit 41J
			Clear	A	<b>8WD42 00-1AE</b>	1	1 unit 41J
			Blue	A	<b>8WD42 00-1AF</b>	1	1 unit 41J
<b>Light elements with integrated LED</b>							
	<b>Continuous light elements</b>	24 AC/DC	Red	A	<b>8WD42 20-5AB</b>	1	1 unit 41J
			Green	A	<b>8WD42 20-5AC</b>	1	1 unit 41J
			Yellow	A	<b>8WD42 20-5AD</b>	1	1 unit 41J
			Clear	X	<b>8WD42 20-5AE</b>	1	1 unit 41J
			Blue	X	<b>8WD42 20-5AF</b>	1	1 unit 41J
	<b>Blinklight elements</b>	24 AC/DC	Red	A	<b>8WD42 20-5BB</b>	1	1 unit 41J
			Green	A	<b>8WD42 20-5BC</b>	1	1 unit 41J
			Yellow	A	<b>8WD42 20-5BD</b>	1	1 unit 41J
			Clear	A	<b>8WD42 20-5BE</b>	1	1 unit 41J
			Blue	A	<b>8WD42 20-5BF</b>	1	1 unit 41J
			115 AC	Red	A	<b>8WD42 40-5BB</b>	1
		Green		A	<b>8WD42 40-5BC</b>	1	1 unit 41J
		Yellow		A	<b>8WD42 40-5BD</b>	1	1 unit 41J
		230 AC	Clear	D	<b>8WD42 40-5BE</b>	1	1 unit 41J
			Blue	D	<b>8WD42 40-5BF</b>	1	1 unit 41J
			Red	A	<b>8WD42 50-5BB</b>	1	1 unit 41J
			Green	A	<b>8WD42 50-5BC</b>	1	1 unit 41J
			Yellow	A	<b>8WD42 50-5BD</b>	1	1 unit 41J
			Clear	A	<b>8WD42 50-5BE</b>	1	1 unit 41J
		Blue	A	<b>8WD42 50-5BF</b>	1	1 unit 41J	
<b>Adapter elements for AS-Interface</b>							
	<b>AS-Interface adapter elements</b> with external auxiliary voltage	For 4 signaling elements 24 V DC	Black	A	<b>8WD42 28-0BB</b>	1	1 unit 41J
							
<b>Connection elements<sup>3)</sup></b>							
	<b>Connection elements with cover</b> For mounting on pipes, floors and angles		Black	A	<b>8WD42 08-0AA</b>	1	1 unit 41J

<sup>1)</sup> One acoustic element can be mounted per signaling column. The cover is included in the scope of supply of the acoustic elements and fixed in place.

<sup>2)</sup> The lamp is not included in the scope of supply. Please order separately.

<sup>3)</sup> The connection element with cover is an essential part for assembling the signaling columns.

#### Note:

For mounting and configuring aid see the publication "Versatile, robust, communication-capable: SIRIUS signaling columns and integrated signal lamps", Order No. E20001-A670-P305.

# Push Button Units and Indicator Lights

## 8WD4 Signaling Columns

### 8WD42 signaling columns, 50 mm diameter

Version	Rated voltage	Color	DT	Order No.	PU (UNIT, SET, M)	PS	
V							
<b>Lamps</b>							
	<b>Incandescent lamps, 5 W</b>						
	Base BA 15d	24 AC/DC	A	<b>8WD43 28-1XX</b>	1	10 units	
		115 AC	A	<b>8WD43 48-1XX</b>	1	10 units	
		230 AC	A	<b>8WD43 58-1XX</b>	1	10 units	
	<b>LEDs</b>						
	Base BA 15d	24 AC/DC	Red	A	<b>8WD44 28-6XB</b>	1	1 unit
			Green	A	<b>8WD44 28-6XC</b>	1	1 unit
			Yellow	A	<b>8WD44 28-6XD</b>	1	1 unit
			Clear	A	<b>8WD44 28-6XE</b>	1	1 unit
			Blue	A	<b>8WD44 28-6XF</b>	1	1 unit
	115 AC		Red	A	<b>8WD44 48-6XB</b>	1	1 unit
			Green	A	<b>8WD44 48-6XC</b>	1	1 unit
			Yellow	A	<b>8WD44 48-6XD</b>	1	1 unit
			Clear	A	<b>8WD44 48-6XE</b>	1	1 unit
			Blue	A	<b>8WD44 48-6XF</b>	1	1 unit
	230 AC		Red	A	<b>8WD44 58-6XB</b>	1	1 unit
			Green	A	<b>8WD44 58-6XC</b>	1	1 unit
			Yellow	A	<b>8WD44 58-6XD</b>	1	1 unit
			Clear	A	<b>8WD44 58-6XE</b>	1	1 unit
Blue			A	<b>8WD44 58-6XF</b>	1	1 unit	
<b>Mounting</b>							
	<b>Feet, single</b>						
		Plastic, for mounting on pipes	A	<b>8WD43 08-0DB</b>	1	1 unit	
		Metal, for pipe lengths > 400 mm	A	<b>8WD43 08-0DC</b>	1	1 unit	
	Plastic, for floor mounting (without pipe)	A	<b>8WD42 08-0DE</b>	1	1 unit		
	<b>Adjustable-angle feet</b> for positioning in 7.5° increments <sup>1)</sup>						
		Plastic, for mounting on pipes, incl. rubber seal	X	<b>8WD44 08-0DF</b>	1	1 unit	
	<b>Pipes, single</b>						
	Length 100 mm		A	<b>8WD42 08-0EF</b>	1	1 unit	
	Length 150 mm		A	<b>8WD43 08-0EE</b>	1	1 unit	
	Length 250 mm		A	<b>8WD43 08-0EA</b>	1	1 unit	
	Length 400 mm		A	<b>8WD43 08-0EB</b>	1	1 unit	
	Length 1000 mm		A	<b>8WD43 08-0ED</b>	1	1 unit	
	<b>Sockets for feet</b>						
		Side cable outlet	A	<b>8WD43 08-0DD</b>	1	1 unit	
	Side cable outlet, with magnetic fixing <sup>2)</sup>	A	<b>8WD43 08-0DE</b>	1	1 unit		
	<b>Brackets for mounting with foot</b>						
			A	<b>8WD44 08-0CC</b>	1	1 unit	
	<b>Brackets for wall mounting</b> (plastic)						
		Mounting without feet and pipe	A	<b>8WD42 08-0CD</b>	1	1 unit	
	<b>Adapters for single-hole mounting</b>						
	Mounting without feet and pipe, with M18 thread and fixing nut	A	<b>8WD42 08-0EH</b>	1	1 unit		

For labeling panels see 8WD44, page 10/159.

<sup>1)</sup> Markings for 30°, 45°, 60° and 90°.

<sup>2)</sup> For horizontal mounting, only 1 element is recommended.

# Push Button Units and Indicator Lights

## 8WD4 Signaling Columns

### 8WD44 signaling columns, 70 mm diameter

#### Overview

Features:

- Thermoplast enclosure, diameter 70 mm
- Advanced design and significantly improved illumination

- Fast and flexible connection using spring-type terminals
- Integrated degree of protection IP65
- Up to 5 elements can be mounted

#### Selection and ordering data

Version	Rated voltage	Color	DT	Order No.	PU (UNIT, SET, M)	PS	
	V						
<b>Acoustic elements<sup>1)</sup></b>							
	<b>Buzzer elements</b> 85 dB, pulsating or continuous tone, adjustable by means of a wire jumper	24 AC/DC	Black	A	<b>8WD44 20-0FA</b>	1	1 unit
		115 AC		A	<b>8WD44 40-0FA</b>	1	1 unit
		230 AC		A	<b>8WD44 50-0FA</b>	1	1 unit
	<b>Siren elements</b> , multi-tone, 100 dB, 8 tones and volume are adjustable	24 AC/DC	Black	A	<b>8WD44 20-0EA2</b>	1	1 unit
		115 AC		A	<b>8WD44 40-0EA2</b>	1	1 unit
		230 AC		A	<b>8WD44 50-0EA2</b>	1	1 unit
<b>Siren elements</b> 108 dB, IP40	24 DC	Black	A	<b>8WD44 20-0EA</b>	1	1 unit	
<b>Light elements for incandescent lamps/LEDs, BA 15d bases<sup>2)</sup></b>							
	<b>Continuous light elements</b>	12 ... 230 AC/DC	Red	A	<b>8WD44 00-1AB</b>	1	1 unit
			Green	A	<b>8WD44 00-1AC</b>	1	1 unit
			Yellow	A	<b>8WD44 00-1AD</b>	1	1 unit
			Clear	A	<b>8WD44 00-1AE</b>	1	1 unit
			Blue	A	<b>8WD44 00-1AF</b>	1	1 unit
	<b>Blinklight elements</b>	24 AC/DC	Red	A	<b>8WD44 20-1BB</b>	1	1 unit
			Green	A	<b>8WD44 20-1BC</b>	1	1 unit
			Yellow	A	<b>8WD44 20-1BD</b>	1	1 unit
			Clear	A	<b>8WD44 20-1BE</b>	1	1 unit
			Blue	A	<b>8WD44 20-1BF</b>	1	1 unit
		115 AC	Red	A	<b>8WD44 40-1BB</b>	1	1 unit
			Green	A	<b>8WD44 40-1BC</b>	1	1 unit
			Yellow	A	<b>8WD44 40-1BD</b>	1	1 unit
			Clear	A	<b>8WD44 40-1BE</b>	1	1 unit
			Blue	A	<b>8WD44 40-1BF</b>	1	1 unit
		230 AC	Red	A	<b>8WD44 50-1BB</b>	1	1 unit
			Green	A	<b>8WD44 50-1BC</b>	1	1 unit
			Yellow	A	<b>8WD44 50-1BD</b>	1	1 unit
			Clear	A	<b>8WD44 50-1BE</b>	1	1 unit
			Blue	A	<b>8WD44 50-1BF</b>	1	1 unit
<b>Light elements with integrated flash lamps<sup>3)</sup></b>							
	<b>Flashlight elements</b> with integrated electronic flash	24 DC	Red	A	<b>8WD44 20-0CB</b>	1	1 unit
			Green	A	<b>8WD44 20-0CC</b>	1	1 unit
			Yellow	A	<b>8WD44 20-0CD</b>	1	1 unit
			Clear	A	<b>8WD44 20-0CE</b>	1	1 unit
			Blue	A	<b>8WD44 20-0CF</b>	1	1 unit
		115 AC	Red	A	<b>8WD44 40-0CB</b>	1	1 unit
			Green	D	<b>8WD44 40-0CC</b>	1	1 unit
			Yellow	A	<b>8WD44 40-0CD</b>	1	1 unit
			Clear	D	<b>8WD44 40-0CE</b>	1	1 unit
			Blue	D	<b>8WD44 40-0CF</b>	1	1 unit
		230 AC	Red	A	<b>8WD44 50-0CB</b>	1	1 unit
			Green	A	<b>8WD44 50-0CC</b>	1	1 unit
			Yellow	A	<b>8WD44 50-0CD</b>	1	1 unit
			Clear	A	<b>8WD44 50-0CE</b>	1	1 unit
			Blue	A	<b>8WD44 50-0CF</b>	1	1 unit

<sup>1)</sup> One acoustic element can be mounted per signaling column. The cover is included in the scope of supply of the acoustic elements and fixed in place.

<sup>2)</sup> The lamp is not included in the scope of supply. Please order separately.

<sup>3)</sup> The lamp is included in the scope of supply.

# Push Button Units and Indicator Lights

## 8WD4 Signaling Columns

### 8WD44 signaling columns, 70 mm diameter

1  
2  
3  
4  
5  
6  
7  
8  
9  
10

Version	Rated voltage	Color	DT	Order No.	PU (UNIT, SET, M)	PS	
V							
<b>Light elements with integrated LED</b>							
	<b>Continuous light elements</b>	24 AC/DC	Red	A	<b>8WD44 20-5AB</b>	1	1 unit
			Green	A	<b>8WD44 20-5AC</b>	1	1 unit
			Yellow	A	<b>8WD44 20-5AD</b>	1	1 unit
			Clear	A	<b>8WD44 20-5AE</b>	1	1 unit
			Blue	A	<b>8WD44 20-5AF</b>	1	1 unit
		115 AC	Red	A	<b>8WD44 40-5AB</b>	1	1 unit
			Green	A	<b>8WD44 40-5AC</b>	1	1 unit
			Yellow	A	<b>8WD44 40-5AD</b>	1	1 unit
			Clear	A	<b>8WD44 40-5AE</b>	1	1 unit
			Blue	A	<b>8WD44 40-5AF</b>	1	1 unit
		230 AC	Red	A	<b>8WD44 50-5AB</b>	1	1 unit
			Green	A	<b>8WD44 50-5AC</b>	1	1 unit
			Yellow	A	<b>8WD44 50-5AD</b>	1	1 unit
			Clear	A	<b>8WD44 50-5AE</b>	1	1 unit
			Blue	A	<b>8WD44 50-5AF</b>	1	1 unit
	<b>Blinklight elements</b>	24 AC/DC	Red	A	<b>8WD44 20-5BB</b>	1	1 unit
			Green	A	<b>8WD44 20-5BC</b>	1	1 unit
			Yellow	A	<b>8WD44 20-5BD</b>	1	1 unit
			Clear	X	<b>8WD44 20-5BE</b>	1	1 unit
			Blue	A	<b>8WD44 20-5BF</b>	1	1 unit
			115 AC	Red	A	<b>8WD44 40-5BB</b>	1
			Green	A	<b>8WD44 40-5BC</b>	1	1 unit
			Yellow	A	<b>8WD44 40-5BD</b>	1	1 unit
			Clear	A	<b>8WD44 40-5BE</b>	1	1 unit
			Blue	A	<b>8WD44 40-5BF</b>	1	1 unit
		230 AC	Red	A	<b>8WD44 50-5BB</b>	1	1 unit
			Green	A	<b>8WD44 50-5BC</b>	1	1 unit
		Yellow	A	<b>8WD44 50-5BD</b>	1	1 unit	
		Clear	A	<b>8WD44 50-5BE</b>	1	1 unit	
		Blue	A	<b>8WD44 50-5BF</b>	1	1 unit	
	<b>Rotating light elements</b>	24 AC/DC	Red	A	<b>8WD44 20-5DB</b>	1	1 unit
			Green	A	<b>8WD44 20-5DC</b>	1	1 unit
			Yellow	A	<b>8WD44 20-5DD</b>	1	1 unit

### Adapter elements for AS-Interface

	<b>AS-Interface adapter elements</b>					
	With/without external auxiliary voltage, switchable					
	<ul style="list-style-type: none"> <li>• A/B technology</li> <li>• Standard AS-i</li> </ul>		For 3 signaling elements 24 V DC For 4 signaling elements 24 V DC	Black Black	A A	<b>8WD44 28-0BD</b> <b>8WD44 28-0BE</b>

### Connection elements<sup>1)</sup>

	<b>Connection elements with cover</b>	Black					
	Screw terminals						
	<ul style="list-style-type: none"> <li>• For mounting on pipes</li> <li>• For mounting on brackets and floors</li> </ul>			A	<b>8WD44 08-0AA</b> <b>8WD44 08-0AB</b>	1 1	1 unit 1 unit
	Spring-type terminals						
	<ul style="list-style-type: none"> <li>• For mounting on pipes</li> <li>• For mounting on brackets and floors</li> </ul>			A	<b>8WD44 08-0AD</b> <b>8WD44 08-0AE</b>	1 1	1 unit 1 unit
	Cover (replacement)			A	<b>8WD44 08-0XA</b>	1	1 unit

<sup>1)</sup> The connection element with cover is an essential part for assembling the signaling columns.

# Push Button Units and Indicator Lights

## 8WD4 Signaling Columns

• Revised •  
11/15/14

8WD44 signaling columns, 70 mm diameter

Version	DT	Order No.	PU (UNIT, SET, M)	PS		
<b>Mounting</b>						
	<b>Foot with pipe</b>	Plastic foot with pipe length 100 mm	A	<b>8WD43 08-0DA</b>	1	1 unit
	<b>Feet, single</b>	Plastic, for mounting on pipes	A	<b>8WD43 08-0DB</b>	1	1 unit
		Metal, for pipe lengths > 400 mm	A	<b>8WD43 08-0DC</b>	1	1 unit
	<b>Adjustable-angle feet</b> for positioning in 7.5° increments <sup>1)</sup>	Plastic, for mounting on pipes, incl. rubber seal	X	<b>8WD44 08-0DF</b>	1	1 unit
	<b>Pipes, single</b>	Length 100 mm	A	<b>8WD42 08-0EF</b>	1	1 unit
		Length 150 mm	A	<b>8WD43 08-0EE</b>	1	1 unit
		Length 250 mm	A	<b>8WD43 08-0EA</b>	1	1 unit
		Length 400 mm	A	<b>8WD43 08-0EB</b>	1	1 unit
		Length 1000 mm	A	<b>8WD43 08-0ED</b>	1	1 unit
	<b>Sockets for feet</b>	Side cable outlet (can also be used without feet)	A	<b>8WD43 08-0DD</b>	1	1 unit
		Side cable outlet, with magnetic fixing <sup>2)</sup>	A	<b>8WD43 08-0DE</b>	1	1 unit
	<b>Brackets for wall mounting</b> (mounting without feet and pipe)	For single-sided mounting	A	<b>8WD43 08-0CA</b>	1	1 unit
		For double-sided mounting	A	<b>8WD43 08-0CB</b>	1	1 unit
<b>Brackets for mounting with foot</b>		A	<b>8WD44 08-0CC</b>	1	1 unit	
<b>Brackets for base mounting</b>	Mounting without feet and pipe	A	<b>8WD44 08-0CD</b>	1	1 unit	
<b>Adapter for mounting on pipes according to NPT</b>	Mounting on pipes, Ø 25 mm, with NPT 1/2" thread	A	<b>8WD43 08-0DF</b>	1	1 unit	

<sup>1)</sup> Markings for 30°, 45°, 60° and 90°.

<sup>2)</sup> For horizontal mounting, only 1 element is recommended.

**Note:**

For mounting and configuring aid see the publication "Versatile, robust, communication-capable: SIRIUS signaling columns and integrated signal lamps", Order No. E20001-A670-P305.

# Push Button Units and Indicator Lights

## 8WD4 Signaling Columns

### 8WD44 signaling columns, 70 mm diameter

1  
2  
3  
4  
5  
6  
7  
8  
9  
10

Version	Rated voltage	Color	DT	Order No.	PU (UNIT, SET, M)	PS
---------	---------------	-------	----	-----------	-------------------------	----

V

#### Lamps



#### Incandescent lamps, 5 W

Base BA 15d	24 AC/DC		A	<b>8WD43 28-1XX</b>	1	10 units
	115 AC		A	<b>8WD43 48-1XX</b>	1	10 units
	230 AC		A	<b>8WD43 58-1XX</b>	1	10 units



#### LEDs

Base BA 15d	24 AC/DC	Red	A	<b>8WD44 28-6XB</b>	1	1 unit
		Green	A	<b>8WD44 28-6XC</b>	1	1 unit
		Yellow	A	<b>8WD44 28-6XD</b>	1	1 unit
		Clear	A	<b>8WD44 28-6XE</b>	1	1 unit
		Blue	A	<b>8WD44 28-6XF</b>	1	1 unit
		115 AC	Red	A	<b>8WD44 48-6XB</b>	1
		Green	A	<b>8WD44 48-6XC</b>	1	1 unit
		Yellow	A	<b>8WD44 48-6XD</b>	1	1 unit
		Clear	A	<b>8WD44 48-6XE</b>	1	1 unit
		Blue	A	<b>8WD44 48-6XF</b>	1	1 unit
	230 AC	Red	A	<b>8WD44 58-6XB</b>	1	1 unit
		Green	A	<b>8WD44 58-6XC</b>	1	1 unit
	Yellow	A	<b>8WD44 58-6XD</b>	1	1 unit	
	Clear	A	<b>8WD44 58-6XE</b>	1	1 unit	
	Blue	A	<b>8WD44 58-6XF</b>	1	1 unit	

#### Inscriptions



#### Labeling panels

With fixing accessories for mounting on pipe  $\varnothing$  25 mm  
 Inscription area/ step 50 mm x 140 mm  
 Suitable for standard labels, e.g.

- Zweckform 3425
- Herma 4457

			A	<b>8WD44 08-0FA</b>	1	1 unit
--	--	--	---	---------------------	---	--------

# Push Button Units and Indicator Lights

## 8WD53 Beacons

8WD53 beacons, 70 mm diameter

### Overview



Integrated signal lamps

### Design

Features:

- Thermoplast enclosures, diameter 70 mm
- Degree of protection IP65
- Rated voltage 24 V, 115 V, 230 V AC/DC
- Ambient temperature -20 to +50 °C, incandescent lamp up to 60 °C

The special shape of the integrated signal lamps means that the light is emitted optimally in every direction (to the sides and upwards). Continuous lights (with incandescent lamp or LED) and single-flash lights are available in five colors.





The LED versions of the integrated signal lamps offer a considerably longer endurance than the incandescent lamp versions.

All integrated signal lamps have a high degree of protection IP65 and are made of a material highly resistant to impact.

### Mounting

8WD53 integrated signal lamps can be mounted directly at any point of the machine for the purpose of giving visual signals. They are mounted by means of a PG29 screw base with nut.

### Selection and ordering data

Version	Rated voltage	Color	DT	Order No.	Price per PU	PU (UNIT, SET, M)	PS	PG				
<b>Luminaires for incandescent lamps/LED, BA 15d base</b>												
	Continuous light <sup>1)</sup>	12 ... 230 AC/DC	Red	A	<b>8WD53 00-1AB</b>		1	1 unit	41J			
				A	<b>8WD53 00-1AC</b>		1	1 unit	41J			
				A	<b>8WD53 00-1AD</b>		1	1 unit	41J			
				A	<b>8WD53 00-1AE</b>		1	1 unit	41J			
				A	<b>8WD53 00-1AF</b>		1	1 unit	41J			
	Single-flash light with integrated electronic flash	24 AC/DC	Red	A	<b>8WD53 20-0CB</b>		1	1 unit	41J			
				D	<b>8WD53 20-0CC</b>		1	1 unit	41J			
				A	<b>8WD53 20-0CD</b>		1	1 unit	41J			
				A	<b>8WD53 20-0CE</b>		1	1 unit	41J			
				A	<b>8WD53 20-0CF</b>		1	1 unit	41J			
					115 AC	Red	A	<b>8WD53 40-0CB</b>		1	1 unit	41J
							D	<b>8WD53 40-0CC</b>		1	1 unit	41J
							D	<b>8WD53 40-0CD</b>		1	1 unit	41J
							D	<b>8WD53 40-0CE</b>		1	1 unit	41J
							D	<b>8WD53 40-0CF</b>		1	1 unit	41J
					230 AC	Red	A	<b>8WD53 50-0CB</b>		1	1 unit	41J
							D	<b>8WD53 50-0CC</b>		1	1 unit	41J
							A	<b>8WD53 50-0CD</b>		1	1 unit	41J
							A	<b>8WD53 50-0CE</b>		1	1 unit	41J
							D	<b>8WD53 50-0CF</b>		1	1 unit	41J
	Continuous light	24 AC/DC	Red	A	<b>8WD53 20-5AB</b>		1	1 unit	41J			
				A	<b>8WD53 20-5AC</b>		1	1 unit	41J			
				A	<b>8WD53 20-5AD</b>		1	1 unit	41J			
	Blinklight lamps	24 AC/DC	Red	A	<b>8WD53 20-5BB</b>		1	1 unit	41J			
				D	<b>8WD53 20-5BC</b>		1	1 unit	41J			
				A	<b>8WD53 20-5BD</b>		1	1 unit	41J			
	Rotating light	24 AC/DC	Red	A	<b>8WD53 20-5DB</b>		1	1 unit	41J			
				A	<b>8WD53 20-5DC</b>		1	1 unit	41J			
				A	<b>8WD53 20-5DD</b>		1	1 unit	41J			

For incandescent lamps and LEDs see "Signaling Columns" page 10/159

<sup>1)</sup> Lamp not included in scope of supply. Please order separately.



# Push Button Units and Indicator Lights

## 8WD4 Signaling Columns

### Dimension drawings

1

2

3

4

5

6

7

8

9

10

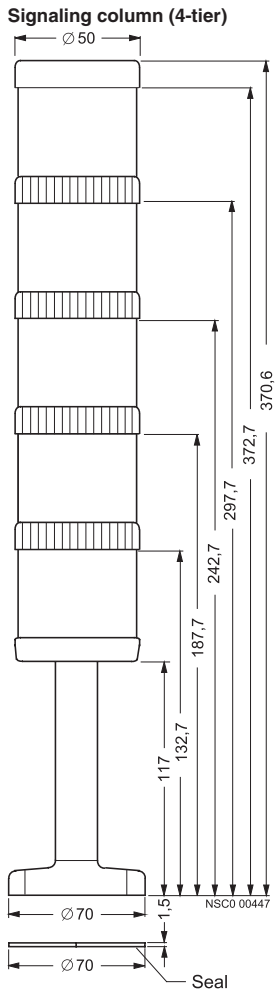

**Foot**

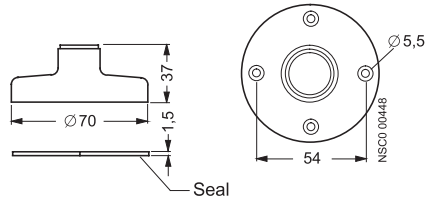

**Connection element**

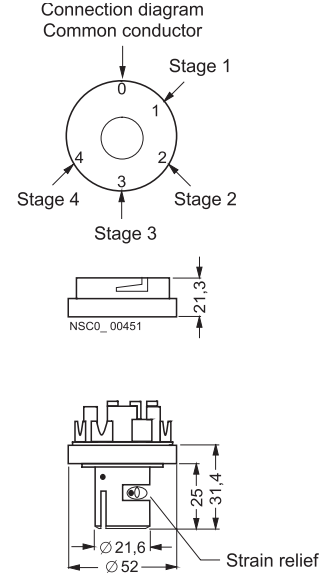

**Bracket for wall mounting**

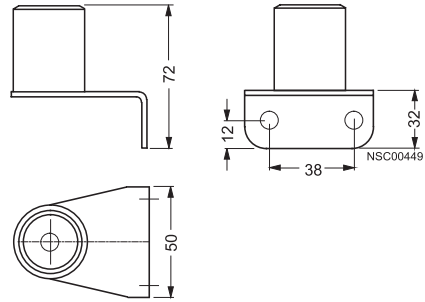

**Adapter for single-hole mounting**

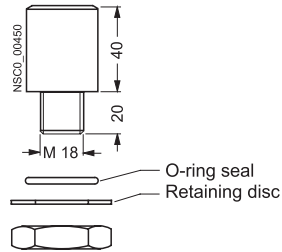

# Push Button Units and Indicator Lights

## 8WD4 Signaling Columns

### Dimension drawings

#### Dimension drawings

##### Signaling column (5-tier)

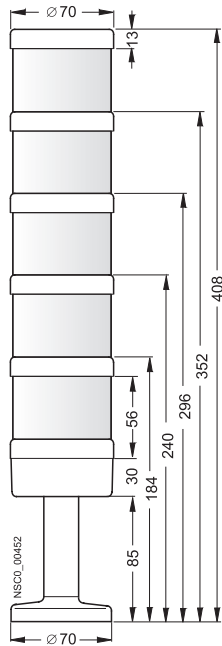

##### Connection diagrams

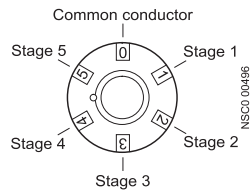

conventional

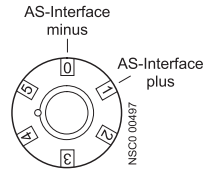

with AS-Interface,  
without external auxiliary  
voltage

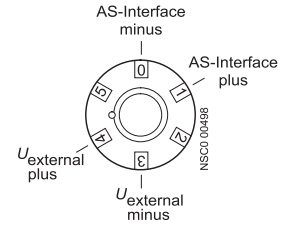

with external auxiliary voltage

##### Connection element and cover for mounting on pipes

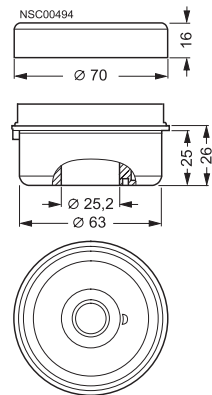

##### Connection element and cover for mounting on floor/bracket

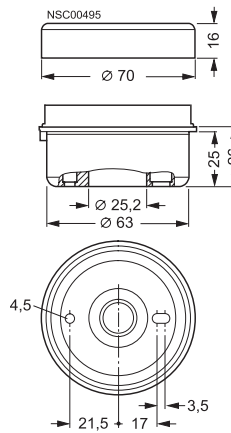

##### Foot with pipe

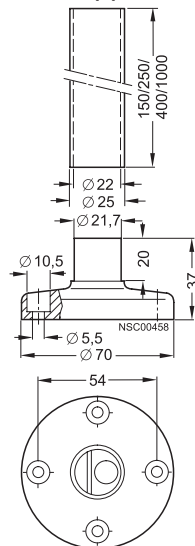

##### Bracket for single-sided mounting

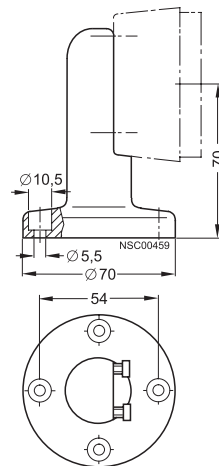

##### Bracket for double-sided mounting

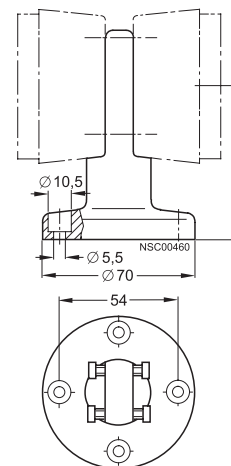

### Dimension drawings

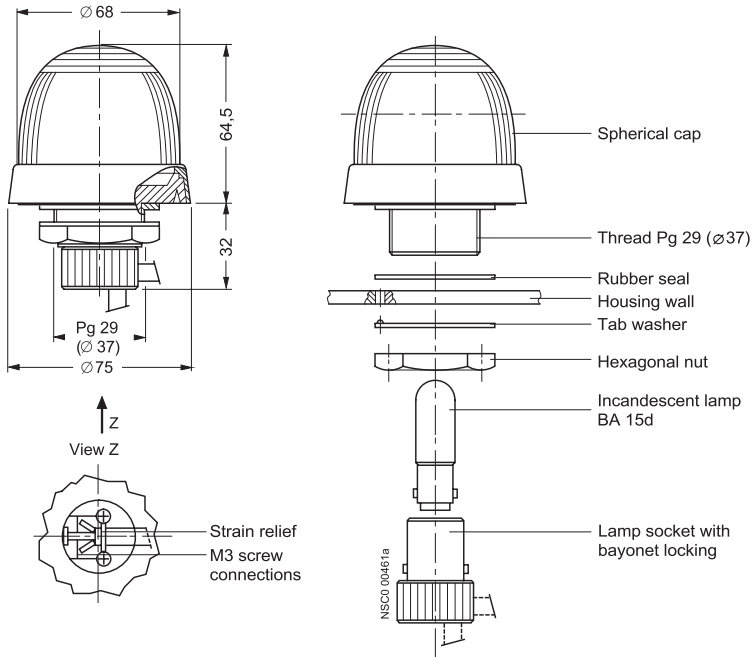

# Pushbutton Units and Indicator Lights

## Class 50 Standard Duty Pushbutton Stations

### General

#### Features

- Snap In Legend Inserts
- Flush and Surface Mounted Types
- Convertible Selector
- Double Break Contacts
- Dual Voltage Pilot Light with Snap In Lens
- Conversion Kits
- UL Listed File #E22655
- CSA Certified File #LR6535

#### Application

Standard duty control stations are used with magnetic controllers to control the starting, stopping, reversing or speed of applicable motors.

Stations are assembled of one, two or three push button, selector switch or pilot light units in a variety of combinations to provide compact control units for remote control of magnetic starters and contactors.

Station enclosures are available in Type 1 surface mounted, 1B flush plate mounted and 4 watertight.

#### Features

Type 1 surface mounted bases are constructed of 14 gauge sheet steel, primed and finished in baked gray enamel. The base is predrilled to receive a variety of contact blocks, pilot lights and accessory devices. Covers are of 20 gauge sheet steel, wrap-around construction, primed and finished in baked gray enamel. Siemens Type 4 watertight heavy duty push button stations are supplied with a provision to padlock the stop button in the depressed position. Enclosures are predrilled and tapped for 3/4" conduit.

Contact blocks have double break, fine silver contacts with a NEMA B600 rating. Type 4 stations have a NEMA A600 rating.

The pilot light assembly is dual voltage with clearly marked pressure type terminals for 120 volt or 240 volt connection.

The lens of the pilot light snaps into the cover and is available in both red and green.

Push buttons are equipped with an operator into which a selected legend insert is snapped. Legend inserts are molded thermoplastic and come in a wide variety of legends and colors.

The selector switch operator can be instantly set for two or three positions at any time.

#### Mushroom Head

50ZMH mounts on any standard push button operator. The Mushroom Head is red molded thermoplastic, 1 1/2" in diameter, and provides a large operator for emergency stop or similar applications.

#### Mechanical Interlock

50ZAM is a base mounted zinc plate, dichromate dipped, steel assembly. When mounted in conjunction with Duplex Contact Block 50ZAC3 (one NO and one NO) the interlock prevents one contact from being closed while the other contact is closed.

#### Padlock Attachment Kit

50ZAL can be mounted to any Type 1 surface mounted station by the lower screw which fastens the cover to the station base. Made of heavy steel, chrome plated, the attachment provides for the padlocking of a push button in the depressed position or a selector switch in any position. When used with a push button operator, raised Legend Insert D53493003 (Red Stop) must be used.

#### Electrical Ratings

NEMA AC Ratings 50/60Hz

Nema B600 5 Continuous Amps

Volts	Make	Break
120	30	3
240	15	1.5
480	7.5	0.75
600	6	0.6
VA	3600	360

#### Ordering Information

- Legend Inserts [see page 10/171](#).
- Accessories [see page 10/171](#).



**2 Push Buttons  
Surface Mounting, NEMA 1**



**2 Push Buttons  
Flush Mounting, NEMA 1B**



**1 Push Button  
Surface Mounting**



**1 Selector Switch  
Flush Mounting**



**2 Push Buttons  
1 Selector Switch**

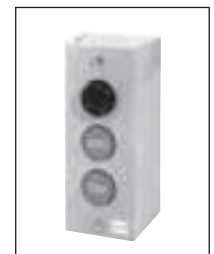



**1 Pilot Light  
2 Push Buttons**

# Pushbutton Units and Indicator Lights

## Class 50 Standard Duty Pushbutton Stations

5A 600V AC NEMA B600

### Selection and ordering data



	Operator identification	Degree of protection	Contacts / voltage	Number of command points	Order No.	Packs
						Unit
 <p>1 unit surface mount-momentary pushbutton</p>	A = Momentary flush pushbutton green, surface, label "START"	NEMA 1	1NO - 1NC with common jumper (50ZAC1)	1	<b>50AA3D</b>	1
	A = Momentary flush pushbutton red, surface, label "STOP"	NEMA 1	1NO - 1NC with common jumper (50ZAC1)	1	<b>50AA3E</b>	1
	A = Momentary raised pushbutton red, surface, label "STOP"	NEMA 1	1NO - 1NC with common jumper (50ZAC1)	1	<b>50AA3F</b>	1
	A = Momentary mushroom head red, surface, label "STOP"	NEMA 1	1NO - 1NC with common jumper (50ZAC1)	1	<b>50AA3G</b>	1
	A = Momentary flush pushbutton less insert, surface	NEMA 1	1NO - 1NC with common jumper (50ZAC1)	1	<b>50AA3A</b>	1
	A = 3 position selector switch, surface, label "HAND-OFF-AUTO"	NEMA 1	2 NO 2SPST (50ZAC8)	1	<b>50AA3C3</b>	1
	A = 2 position selector switch, surface, label "Off-On"	NEMA 1	2 NO 2SPST (50ZAC8)	1	<b>50AA3C6</b>	1
	A = 2/3 selector switch, surface, multiple legends	NEMA 1	2 NO 2SPST (50ZAC8)	1	<b>50AA3B9</b>	1
	A = Indicator light, red, surface	NEMA 1	120/240V dual voltage 120PSB lamp	1	<b>50BA3Y</b>	1
	A = Indicator light, green, surface	NEMA 1	120/240V dual voltage 120PSB lamp	1	<b>50BA3Z</b>	1
A = Indicator light, less lens, surface	NEMA 1	120/240V dual voltage 120PSB lamp	1	<b>50BA32</b>	1	
 <p>1 unit flush mount-momentary pushbutton</p>	A = Momentary flush pushbutton green, flush, label "START"	NEMA 1B	1NO - 1NC with common jumper (50ZAC1)	1	<b>50AA2D</b>	1
	A = Momentary flush pushbutton red, flush, label "STOP"	NEMA 1B	1NO - 1NC with common jumper (50ZAC1)	1	<b>50AA2E</b>	1
	A = Momentary raised pushbutton red, flush, label "STOP"	NEMA 1B	1NO - 1NC with common jumper (50ZAC1)	1	<b>50AA2F</b>	1
	A = Momentary flush pushbutton less insert, flush	NEMA 1B	1NO - 1NC with common jumper (50ZAC1)	1	<b>50AA2A</b>	1
	A = Momentary flush pushbutton less insert, flush, chrome plate	NEMA 1B	1NO - 1NC with common jumper (50ZAC1)	1	<b>50AA6A</b>	1
	A = 3 position selector switch, flush, label "HAND-OFF-AUTO"	NEMA 1B	2 NO 2SPST (50ZAC8)	1	<b>50AA2C3</b>	1
	A = 3 position selector switch, flush, label "Off-On"	NEMA 1B	2 NO 2SPST (50ZAC8)	1	<b>50AA2C6</b>	1
	A = 2/3 selector switch, multiple legends, flush	NEMA 1B	2 NO 2SPST (50ZAC8)	1	<b>50AA2B9</b>	1
	A = 2/3 selector switch, multiple legends, chrome plate, flush	NEMA 1B	2 NO 2SPST (50ZAC8)	1	<b>50AA6B9</b>	1
	A = Indicator light, red, flush	NEMA 1B	120/240V dual voltage	1	<b>50BA2Y</b>	1
A = Indicator light, green, flush	NEMA 1B	120/240V dual voltage	1	<b>50BA2Z</b>	1	
A = Indicator light, less lens, flush	NEMA 1B	120/240V dual voltage	1	<b>50BA22</b>	1	
A = Indicator light, less lens, chrome plate, flush	NEMA 1B	120PSB lamp	1	<b>50BA62</b>	1	
 <p>2 unit surface mount-momentary pushbutton</p>	B = Momentary pushbutton green, surface, label "START"	NEMA 1	1NO, 1NC (50ZAC2)	2	<b>50CA3DE</b>	1
	A = Momentary pushbutton red, surface, label "STOP"					
	B = Momentary pushbutton green, surface, label "START"	NEMA 1	1NO, 1NC (50ZAC2)	2	<b>50CA3DF</b>	1
	A = Momentary raised pushbutton red, surface, label "STOP"					
	B = Momentary pushbutton green, surface, label "START"	NEMA 1	1NO, 1NC (50ZAC2)	2	<b>50CA3DG</b>	1
	A = Momentary mushroom head pushbutton red, surface, label "STOP"					
	B = Momentary pushbutton, less insert, surface	NEMA 1	1NO, 1NC (50ZAC2)	2	<b>50CA3AA</b>	1
	A = Momentary pushbutton, less insert, surface					
	B = Momentary pushbutton, surface, label "FORWARD"	NEMA 1	2 NO (50ZAC3)	2	<b>50DA3KL</b>	1
	A = Momentary pushbutton, surface, label "REVERSE"					

# Pushbutton Units and Indicator Lights

## Class 50 Standard Duty Pushbutton Stations

5A 600V AC NEMA B600

### Selection and ordering data

	Operator identification	Degree of protection	Contacts / voltage	Number of command points	Order No.	Packs
						Unit
<p>2 unit surface mount-momentary pushbutton</p> 	B = Momentary pushbutton, surface, label "OPEN" A = Momentary pushbutton, surface, label "CLOSE"	NEMA 1	2 NO (50ZAC3)	2	<b>50DA3HJ</b>	1
	B = Momentary pushbutton, surface, label "UP" A = Momentary pushbutton, surface, label "DOWN"	NEMA 1	2 NO (50ZAC3)	2	<b>50DA3NP</b>	1
	B = Momentary pushbutton, surface, less insert A = Momentary pushbutton, surface, less insert	NEMA 1	2 NO (50ZAC3)	2	<b>50DA3AA</b>	1
	B = Momentary pushbutton, surface, label "FORWARD" A = Momentary pushbutton, surface, label "REVERSE"	NEMA 1	2 NO mechanically interlocked (50ZA3C w/ 50ZAM)	2	<b>50RA3KL</b>	1
	B = Momentary pushbutton, surface, label "OPEN" A = Momentary pushbutton, surface, label "CLOSE"	NEMA 1	2 NO mechanically interlocked (50ZA3C w/ 50ZAM)	2	<b>50RA3HJ</b>	1
	B = Momentary pushbutton, surface, label "UP" A = Momentary pushbutton, surface, label "DOWN"	NEMA 1	2 NO mechanically interlocked (50ZA3C w/ 50ZAM)	2	<b>50RA3NP</b>	1
	B = Momentary pushbutton, surface, label "ON" A = Momentary pushbutton, surface, label "OFF"	NEMA 1	2 NO mechanically interlocked (50ZA3C w/ 50ZAM)	2	<b>50RA334</b>	1
	B = Momentary pushbutton, less insert surface A = Momentary pushbutton, less insert, surface	NEMA 1	2 NO mechanically interlocked (50ZA3C w/ 50ZAM)	2	<b>50RA3AA</b>	1
	B = Momentary pushbutton, surface, label "FORWARD" A = Momentary pushbutton, surface, label "REVERSE"	NEMA 1	2 NO, 2 NC (2 - 50ZAC2)	2	<b>50EA3KL</b>	1
	B = Momentary pushbutton, surface, label "OPEN" A = Momentary pushbutton, surface, label "CLOSE"	NEMA 1	2 NO, 2 NC (2 - 50ZAC2)	2	<b>50EA3HJ</b>	1
	B = Momentary pushbutton, surface, label "UP" A = Momentary pushbutton, surface, label "DOWN"	NEMA 1	2 NO, 2 NC (2 - 50ZAC2)	2	<b>50EA3NP</b>	1
	B = Momentary pushbutton, surface, label "ON" A = Momentary pushbutton, surface, label "OFF"	NEMA 1	2 NO, 2 NC (2 - 50ZAC2)	2	<b>50EA334</b>	1
	B = Momentary pushbutton, surface, less insert A = Momentary pushbutton, surface, less insert	NEMA 1	2 NO, 2 NC (2 - 50ZAC2)	2	<b>50EA3AA</b>	1
	<p>2 unit flush mount-momentary pushbutton</p> 	B = Momentary pushbutton green, flush, label "START" A = Momentary pushbutton red, flush, label "STOP"	NEMA 1B	1NO, 1NC (50ZAC2)	2	<b>50CA2DE</b>
B = Momentary pushbutton, less insert, flush A = Momentary pushbutton, less insert, flush		NEMA 1B	1NO, 1NC (50ZAC2)	2	<b>50CA2AA</b>	1
B = Momentary pushbutton green, flush, label "START" A = Momentary raised pushbutton red, flush, label "STOP"		NEMA 1B	1NO, 1NC (50ZAC2)	2	<b>50CA2DF</b>	1
B = Momentary pushbutton green, flush, label "START" A = Momentary mushroom head pushbutton red, flush, label "STOP"		NEMA 1B	1NO, 1NC (50ZAC2)	2	<b>50CA2DG</b>	1
B = Momentary pushbutton, less insert, flush A = Momentary pushbutton, less insert, flush		NEMA 1B	1NO, 1NC (50ZAC2)	2	<b>50CA6AA</b>	1

# Pushbutton Units and Indicator Lights

## Class 50 Standard Duty Pushbutton Stations

5A 600V AC NEMA A600

1  
2  
3  
4  
5  
6  
7  
8  
9  
10

### Selection and ordering data

	Operator identification	Degree of protection	Contacts / voltage	Number of command points	Order No.	Packs
						Unit
2 unit flush mount-momentary pushbutton	B = Momentary pushbutton, flush, label "FORWARD" A = Momentary pushbutton, flush, label "REVERSE"	NEMA 1B	2 NO (50ZAC3)	2	<b>50DA2KL</b>	1
	B = Momentary pushbutton, flush, label "OPEN" A = Momentary pushbutton, flush, label "CLOSE"	NEMA 1B	2 NO (50ZAC3)	2	<b>50DA2HJ</b>	1
	B = Momentary pushbutton, flush, label "UP" A = Momentary pushbutton, flush, label "DOWN"	NEMA 1B	2 NO (50ZAC3)	2	<b>50DA2NP</b>	1
	B = Momentary pushbutton, less insert, flush A = Momentary pushbutton, less insert, flush	NEMA 1B	2 NO (50ZAC3)	2	<b>50DA2AA</b>	1
	B = Momentary pushbutton, less insert, chrome plate, flush A = Momentary pushbutton, less insert, chrome plate, flush	NEMA 1B	2 NO (50ZAC3)	2	<b>50DA6AA</b>	1
	B = Momentary pushbutton, flush, label "FORWARD" A = Momentary pushbutton, flush, label "REVERSE"	NEMA 1B	2 NO mechanically interlocked (50ZA3C w/ 50ZAM)	2	<b>50RA2KL</b>	1
	B = Momentary pushbutton, flush, label "OPEN" A = Momentary pushbutton, flush, label "CLOSE"	NEMA 1B	2 NO mechanically interlocked (50ZA3C w/ 50ZAM)	2	<b>50RA2HJ</b>	1
	B = Momentary pushbutton, flush, label "UP" A = Momentary pushbutton, flush, label "DOWN"	NEMA 1B	2 NO mechanically interlocked (50ZA3C w/ 50ZAM)	2	<b>50RA2NP</b>	1
	B = Momentary pushbutton, flush, label "ON" A = Momentary pushbutton, flush, label "OFF"	NEMA 1B	2 NO mechanically interlocked (50ZA3C w/ 50ZAM)	2	<b>50RA234</b>	1
	B = Momentary pushbutton, less insert, flush A = Momentary pushbutton, less insert, flush	NEMA 1B	2 NO mechanically interlocked (50ZA3C w/ 50ZAM)	2	<b>50RA2AA</b>	1
	B = Momentary pushbutton, less insert, chrome plate, flush A = Momentary pushbutton, less insert, chrome plate, flush	NEMA 1B	2 NO mechanically interlocked (50ZA3C w/ 50ZAM)	2	<b>50RA6AA</b>	1
	B = Momentary pushbutton, flush, label "FORWARD" A = Momentary pushbutton, flush, label "REVERSE"	NEMA 1B	2 NO, 2 NC (2 - 50ZAC2)	2	<b>50EA2KL</b>	1
	B = Momentary pushbutton, flush, label "OPEN" A = Momentary pushbutton, flush, label "CLOSE"	NEMA 1B	2 NO, 2 NC (2 - 50ZAC2)	2	<b>50EA2HJ</b>	1
	B = Momentary pushbutton, flush, label "UP" A = Momentary pushbutton, flush, label "DOWN"	NEMA 1B	2 NO, 2 NC (2 - 50ZAC2)	2	<b>50EA2NP</b>	1
	B = Momentary pushbutton, flush, label "ON" A = Momentary pushbutton, flush, label "OFF"	NEMA 1B	2 NO, 2 NC (2 - 50ZAC2)	2	<b>50EA234</b>	1
	B = Momentary pushbutton, less insert, flush A = Momentary pushbutton, less insert, flush	NEMA 1B	2 NO, 2 NC (2 - 50ZAC2)	2	<b>50EA2AA</b>	1
	B = Momentary pushbutton, less insert, chrome plate, flush A = Momentary pushbutton, less insert, chrome plate, flush	NEMA 1B	2 NO, 2 NC (2 - 50ZAC2)	2	<b>50EA6AA</b>	1

# Pushbutton Units and Indicator Lights

## Class 50 Standard Duty Pushbutton Stations

### 5A 600V AC NEMA B600

#### Selection and ordering data

	Operator identification	Degree of protection	Contacts / voltage	Number of command points	Order No.	Packs
						Unit
2 unit surface mount-momentary pushbutton and selector switch	B = Momentary pushbutton green, surface, label "START"	NEMA 1	1NO, 1NC (50ZAC1)	2	<b>50FA3DC3</b>	1
	A = Maintained selector switch, surface, label "HAND-OFF-AUTO"		2 NO 2SPDT w/ common jumper (50ZAC8)			
	B = Momentary pushbutton less insert, surface	NEMA 1	1NO, 1NC (50ZAC1)	2	<b>50FA3AB9</b>	1
	A = Maintained selector switch, multiple legends, surface		2 NO 2SPDT w/ common jumper (50ZAC8)			
2 unit surface mount-momentary pushbutton and indicator light	B = Indicator light, red, surface	NEMA 1	120/240V dual voltage (120PSB lamp)	2	<b>50HA3YC3</b>	1
	A = Maintained selector switch, surface, label "HAND-OFF-AUTO"		2 NO 2SPDT w/ common jumper (50ZAC8)			
	B = Indicator light, red, surface	NEMA 1	120/240V dual voltage (120PSB lamp)	2	<b>50HA32B9</b>	1
	A = Maintained selector switch, multiple legends, surface		2 NO 2SPDT w/ common jumper (50ZAC8)			
2 unit surface mount-momentary pushbutton and indicator light	B = Indicator light, green, surface	NEMA 1	120/240V dual voltage (120PSB lamp)	2	<b>50GA3ZY</b>	1
	A = Indicator light, red, surface					
	B = Indicator light, less lens, surface	NEMA 1	120/240V dual voltage (120PSB lamp)	2	<b>50GA322</b>	1
	A = Indicator light, less lens, surface					
2 unit flush mount-momentary pushbutton and selector switch	B = Momentary pushbutton green, flush, label "START"	NEMA 1B	1NO, 1NC (50ZAC1)	2	<b>50FA2DC3</b>	1
	A = Maintained selector switch, flush, label "HAND-OFF-AUTO"		2 NO 2SPDT w/ common jumper (50ZAC8)			
	B = Momentary pushbutton less insert, flush	NEMA 1B	1NO, 1NC (50ZAC1)	2	<b>50FA2AB9</b>	1
	A = Maintained selector switch, multiple legends, flush		2 NO 2SPDT w/ common jumper (50ZAC8)			
	B = Momentary pushbutton less insert chrome plate, flush	NEMA 1B	1NO, 1NC (50ZAC1)	2	<b>50FA6AB9</b>	1
	A = Maintained selector switch, multiple legends, flush		2 NO 2SPDT w/ common jumper (50ZAC8)			
	B = Indicator light, red, flush	NEMA 1B	120/240V dual voltage (120PSB lamp)	2	<b>50HA2YC3</b>	1
	A = Maintained selector switch, flush, label "HAND-OFF-AUTO"		2 NO 2SPDT w/ common jumper (50ZAC8)			
	B = Indicator light, less lens, flush	NEMA 1B	120/240V dual voltage (120PSB lamp)	2	<b>50HA22B9</b>	1
	A = Maintained selector switch, multiple legends, flush		2 NO 2SPDT w/ common jumper (50ZAC8)			
2 unit flush mount-momentary pushbutton and indicator light	B = Indicator light, green, flush	NEMA 1B	120/240V dual voltage (120PSB lamp)	2	<b>50GA2ZY</b>	1
	A = Indicator light, red, flush					
	B = Indicator light, less lens, flush	NEMA 1B	120/240V dual voltage (120PSB lamp)	2	<b>50GA222</b>	1
	A = Indicator light, less lens, flush					
2 unit flush mount-momentary pushbutton and indicator light	B = Indicator light, less lens, chrome plate, flush	NEMA 1B	120/240V dual voltage (120PSB lamp)	2	<b>50GA622</b>	1
	A = Indicator light, less lens, chrome plate, flush					
	B = Indicator light, less lens, chrome plate, flush	NEMA 1B	120/240V dual voltage (120PSB lamp)	2	<b>50HA62B9</b>	1
	A = Maintained selector switch, multiple legends, flush		2 NO 2SPDT w/ common jumper (50ZAC8)			
3 unit surface mount-momentary pushbutton	C = Momentary pushbutton, surface, label "FORWARD"	NEMA 1	2 NO, 2 NC (2 - 50ZAC2)	3	<b>50MA3KLE</b>	1
	B = Momentary pushbutton, surface, label "REVERSE"		1NO - 1NC with common jumper (50ZAC1)			
	A = Momentary pushbutton, surface, label "STOP"					
	C = Momentary pushbutton, surface, label "UP"	NEMA 1	2 NO, 2 NC (2 - 50ZAC2)	3	<b>50MA3NPE</b>	1
	B = Momentary pushbutton, surface, label "DOWN"		1NO - 1NC with common jumper (50ZAC1)			
	A = Momentary pushbutton, surface, label "STOP"					
3 unit surface mount-momentary pushbutton	C = Momentary pushbutton, surface, label "OPEN"	NEMA 1	2 NO, 2 NC (2 - 50ZAC2)	3	<b>50MA3HJE</b>	1
	B = Momentary pushbutton, surface, label "CLOSE"		1NO - 1NC with common jumper (50ZAC1)			
	A = Momentary pushbutton, surface, label "STOP"					



# Pushbutton Units and Indicator Lights

## Class 50 Standard Duty Pushbutton Stations

5A 600V AC NEMA B600

### Selection and ordering data



	Operator identification	Degree of protection	Contacts / voltage	Number of command points	Order No.	Packs
						Unit
3 unit surface mount-momentary pushbutton	C = Momentary pushbutton, surface, label "FAST"	NEMA 1	2 NO, 2 NC (2 - 50ZAC2) 1NO - 1NC with common jumper (50ZAC1)	3	50MA3TUE	1
	B = Momentary pushbutton, surface, label "SLOW"					
	A = Momentary pushbutton, surface, label "STOP"					
	C = Momentary pushbutton, surface, label "START"	NEMA 1	2 NO, 2 NC (2 - 50ZAC2) 1NO - 1NC with common jumper (50ZAC1)	3	50MA3DME	1
	B = Momentary pushbutton, surface, label "JOG"					
	A = Momentary pushbutton, surface, label "STOP"					
	C = Momentary pushbutton, surface, label less insert	NEMA 1	2 NO, 2 NC (2 - 50ZAC2) 1NO - 1NC with common jumper (50ZAC1)	3	50MA3AAA	1
	B = Momentary pushbutton, surface, label less insert					
	A = Momentary pushbutton, surface, label less insert					
3 unit surface mount-momentary pushbutton and selector switch	C = Momentary pushbutton, surface, label "START"	NEMA 1	1 NO, 1 NC (50ZAC2) 2 NO, 2 SPST with common jumper (50ZAC8)	3	50LA3DEC3	1
	B = Momentary pushbutton, surface, label "STOP"					
	A = Maintained selector switch, surface, label "HAND-OFF-AUTO"					
	C = Momentary pushbutton, less insert, surface	NEMA 1	1 NO, 1 NC (50ZAC2) 2 NO, 2 SPST with common jumper (50ZAC8)	3	50LA3AAB9	1
	B = Momentary pushbutton, less insert, surface					
	A = Maintained selector switch, multiple legends, surface					
3 unit surface mount-momentary pushbutton and indicator light	C = Indicator light, red, surface	NEMA 1	120/240V dual voltage (120PSB lamp) 1 NO, 1 NC (50ZAC2)	3	50JA3YDE	1
	B = Momentary pushbutton, surface, label "START"					
	A = Momentary pushbutton, surface, label "STOP"					
	C = Indicator light, green, surface	NEMA 1	120/240V dual voltage (120PSB lamp) 1 NO, 1 NC (50ZAC2)	3	50JA3ZDE	1
	B = Momentary pushbutton, surface, label "START"					
	A = Momentary pushbutton, surface, label "STOP"					
	C = Indicator light, less lens, surface	NEMA 1	120/240V dual voltage (120PSB lamp) 1 NO, 1 NC (50ZAC2)	3	50JA32AA	1
	B = Momentary pushbutton, less insert, surface					
	A = Momentary pushbutton, less insert, surface					
	C = Indicator light, green, surface	NEMA 1	120/240V dual voltage (120PSB lamp) 2 NO, 2 SPST with common jumper (50ZAC8)	3	50NA3ZYC3	1
	B = Indicator light, red, surface					
	A = Maintained selector switch, surface, label "HAND-OFF-AUTO"					
	C = Indicator light, less lens, surface	NEMA 1	120/240V dual voltage (120PSB lamp) 2 NO, 2 SPST with common jumper (50ZAC8)	3	50NA322B9	1
	B = Indicator light, less lens, surface					
	A = Maintained selector switch, multiple legends, surface					

# Pushbutton Units and Indicator Lights

## Class 50 Standard Duty Pushbutton Stations

Heavy duty - 10A 600V AC NEMA A600

### Selection and ordering data

	Operator identification	Degree of protection	Contacts / voltage	Number of command points	Order No.	Packs
						Unit
	A = Momentary pushbutton green, surface, label "START"	NEMA 4	1NO - 1NC	1	<b>50HA1E1</b>	1
	A = Momentary pushbutton red, surface, label "STOP"	NEMA 4	1NO - 1NC	1	<b>50HA1E2</b>	1
	A = Momentary pushbutton green, surface, label "RESET"	NEMA 4	1NO - 1NC	1	<b>50HA1E4</b>	1
	A = Momentary pushbutton green, surface, label "JOG"	NEMA 4	1NO - 1NC	1	<b>50HA1E5</b>	1
	A = Maintained selector switch, surface, label "SAFE-RUN"	NEMA 4	1NO - 1NC	1	<b>50HA1E6</b>	1
	A = Maintained selector switch, surface, label "OFF-ON"	NEMA 4	1NO - 1NC	1	<b>50HA1E7</b>	1
	A = Maintained selector switch, surface, label "JOG-RUN"	NEMA 4	1NO - 1NC	1	<b>50HA1E8</b>	1
	A = Maintained selector switch, surface, label "HAND-OFF-AUTO"	NEMA 4	1NO - 1NC	1	<b>50HA1E9</b>	1
		B = Momentary pushbutton green, surface, label "START"	NEMA 4	1NO - 1NC	2	<b>50HA2E1</b>
A = Momentary pushbutton red, surface, label "STOP"			1NO - 1NC			
B = Momentary pushbutton green, surface, label "FORWARD"		NEMA 4	1NO - 1NC	2	<b>50HA2E2</b>	1
A = Momentary pushbutton red, surface, label "REVERSE"			1NO - 1NC			
B = Momentary pushbutton green, surface, label "UP"		NEMA 4	1NO - 1NC	2	<b>50HA2E3</b>	1
A = Momentary pushbutton red, surface, label "DOWN"			1NO - 1NC			
B = Momentary pushbutton green, surface, label "OPEN"		NEMA 4	1NO - 1NC	2	<b>50HA2E4</b>	1
A = Momentary pushbutton red, surface, label "CLOSE"			1NO - 1NC			
B = Momentary pushbutton green, surface, label "FAST"		NEMA 4	1NO - 1NC	2	<b>50HA2E5</b>	1
A = Momentary pushbutton red, surface, label "SLOW"			1NO - 1NC			
	C = Momentary pushbutton green, surface, label "FORWARD"	NEMA 4	1NO - 1NC	3	<b>50HA3E1</b>	1
	B = Momentary pushbutton green, surface, label "REVERSE"		1NO - 1NC			
	A = Momentary pushbutton red, surface, label "STOP"		1NO - 1NC			
	C = Momentary pushbutton green, surface, label "UP"	NEMA 4	1NO - 1NC	3	<b>50HA3E2</b>	1
	B = Momentary pushbutton green, surface, label "DOWN"		1NO - 1NC			
	A = Momentary pushbutton red, surface, label "STOP"		1NO - 1NC			
	C = Momentary pushbutton green, surface, label "OPEN"	NEMA 4	1NO - 1NC	3	<b>50HA3E3</b>	1
	B = Momentary pushbutton green, surface, label "CLOSE"		1NO - 1NC			
	A = Momentary pushbutton red, surface, label "STOP"		1NO - 1NC			
	C = Momentary pushbutton green, surface, label "START"	NEMA 4	1NO - 1NC	3	<b>50HA3E9</b>	1
	B = Momentary pushbutton green, surface, label "JOG"		1NO - 1NC			
	A = Momentary pushbutton red, surface, label "STOP"		1NO - 1NC			
	C = Momentary pushbutton green, surface, label "FAST"	NEMA 4	1NO - 1NC	3	<b>50HA3E4</b>	1
	B = Momentary pushbutton green, surface, label "SLOW"		1NO - 1NC			
	A = Momentary pushbutton red, surface, label "STOP"		1NO - 1NC			

# Pushbutton Units and Indicator Lights

## Class 50 Standard Duty Pushbutton Stations





### Standard duty station accessories

1  
2  
3  
4  
5  
6  
7  
8  
9  
10

#### Selection and ordering data

Legend inscription insert for snap-on mounting

Inscription	Color	Order No.	Pack
			Unit
Close	Orange	50D53493005	1
Down	Orange	50D53493010	1
Fast	Black	50D53493013	1
Forward	Green	50D53493006	1
High	Black	50D53493015	1
Hoist	Green	50D53493011	1
Jog	Black	50D53493008	1
Low	Black	50D53493016	1
Lower	Orange	50D53493012	1
Off	Red	50D53493018	1
On	Green	50D53493017	1
Open	Green	50D53493004	1
Reverse	Orange	50D53493007	1
Slow	Black	50D53493014	1
Start	Green	50D53493001	1
Stop	Red	50D53493002	1
Stop (raised)	Red	50D53493003	1
Up	Green	50D53493009	1

Version	Suitable for	Color	Order No.	Pack
				Unit
 50ZAC1		Red	<b>50ZMH</b>	1
 50ZAC2			<b>50ZAL</b>	1
	Used only for raised buttons		<b>50ZAM</b>	1
 50ZAC8			<b>50ZAC1</b>	1
 50ZAC3			<b>50ZAC8</b>	1
	Single button		<b>50ZAC2</b>	1
	Selector switch		<b>50ZAC3</b>	1
	Two button			
	Two button			
<b>Pilot light</b>	120/240V Dual Voltage, no lens		<b>50ZAC6</b>	1
<b>Pilot light lens</b>		Red	<b>50ZPL01</b>	1
		Green	<b>50ZPL02</b>	1
<b>Replacement lamps</b>	Class 50 type 1, 1B 120V		<b>50D21983001</b>	1
	Slide base, lamp type 120PSB			

### Heavy duty station accessories

Version	Suitable for	Color	Order No.	Pack
				Unit
<b>Pushbutton caps</b>	NEMA 4 control stations	Red	<b>BHP15X</b>	1
	NEMA 4 control stations	Black	<b>BHP16X</b>	1

# Pushbutton Units and Indicator Lights

## Class 50 Standard Duty Pushbutton Stations

Standard duty - 5A 600V AC NEMA B600

1 Unit Station Surface Mounting—Type 1

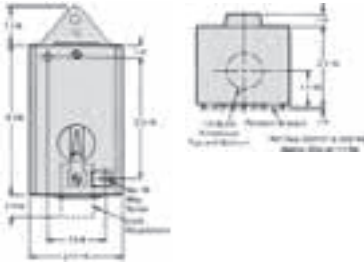

1 Unit Station Flush Mounting—Type 1B

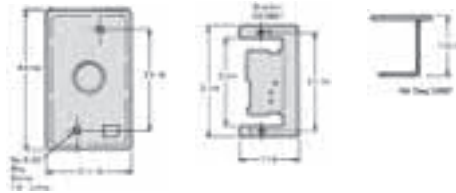

2 Pushbutton Stations Surface Mounting—Type 1

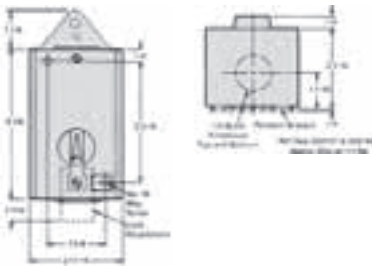

2 Pushbutton Stations Flush Mounting—Type 1B

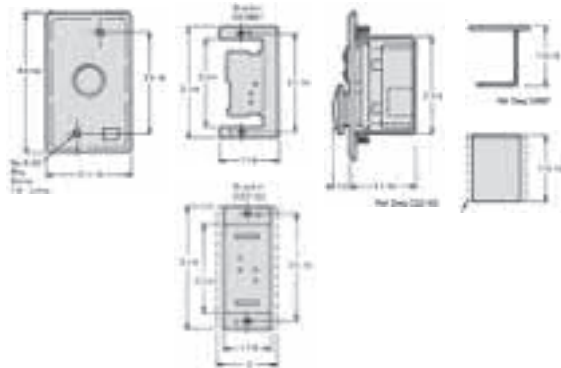

2 Unit Stations Surface Mounting—Type 1

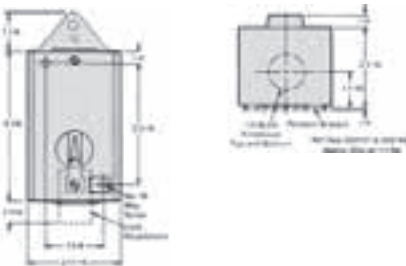

2 Unit Station Flush Mounting—Type 1B

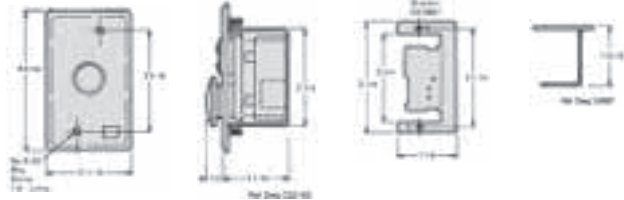

3 Unit Stations Surface Mounting

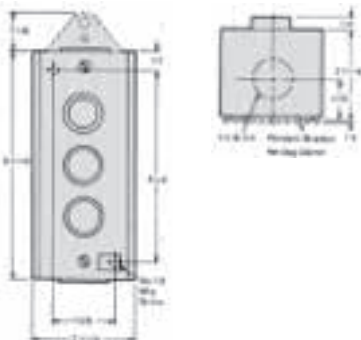

1 Unit Stations—Type 4

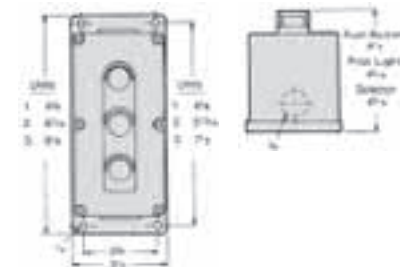

#### Features

- UL Listed and cUL Listed for Class I, Groups C & D and Class II, Groups E, F & G
- Short or Long Bushing Lengths
- Mount into 3/4-14 NPSM Threaded Hole
- Sealing Lock Nut
- Similar in Appearance to Class 52 Oil Tight Pilot Devices
- Double Break Bifurcated Contacts Rated AC NEMA A600, DC NEMA P600
- Ⓢ Positively Driven Contacts
- Touchsafe Terminals
- UL Listed File # E39935

#### Application

When properly installed in a Type 7 & 9 enclosure, these components meet the National Electrical Code's requirements for Class I, Division 1 & 2, Groups C and D hazardous gases, Class II, Division 1, Groups E, F and G hazardous dust, and Class III, hazardous fibers and flyings. Class 51 pilot devices may be used in a location where the presence of flammable gases, vapors or finely pulverized dusts in the atmosphere are sufficient to create a threat of explosion or fire. They may also be required where easily ignitable fibers or flyings are present. Short bushing units are used in most standard Type 7 & 9 enclosures. Long bushings are used when an additional front panel is required or in enclosures up to 2 V8 inches thick. Class 51 devices also meet Type 4 applications.

#### Rugged

Hazardous location control units are durable one piece castings of a corrosion resistant copper free aluminum alloy with stainless steel springs and type 316 stainless steel shafts to provide a long dependable life. The "O" ring ensures the longest seal life available. Contact blocks have double break bifurcated contacts for increased reliability.

#### Flexible

Control units mount into industry standard 3/4-14 NPSM threaded holes. Both short bushings for enclosure mounting and long bushings for panel mounting are available.

Pilot light bulbs are removable from the front for ease of maintenance. Many common parts between the Class 51 hazardous location pilot devices and the Class 52 oil tight pilot devices allow for increased serviceability with fewer parts.

#### Industrial Appearance

Hazardous location control units add luster to panels. They are uniform in appearance and match 52 Class oil tight pilot devices.

#### Typical Applications

##### Class I

##### Class II

##### Class III

#### Electrical Ratings

NEMA AC Ratings 50/60Hz

Nema A600 10 Continuous Amps

Volts	Make	Break
120	60	6
240	30	3
480	15	1.5
600	12	1.2
VA	7200	720

#### Ordering Information

- Accessories [see page 10/181-10/182](#).
- Selector Operating Position and Contact Operation [page 10/179](#).
- Legend Plates [see page 10/218](#).
- Enclosures [see page 10/180](#).
- Technical Specifications: [page 10/220](#).

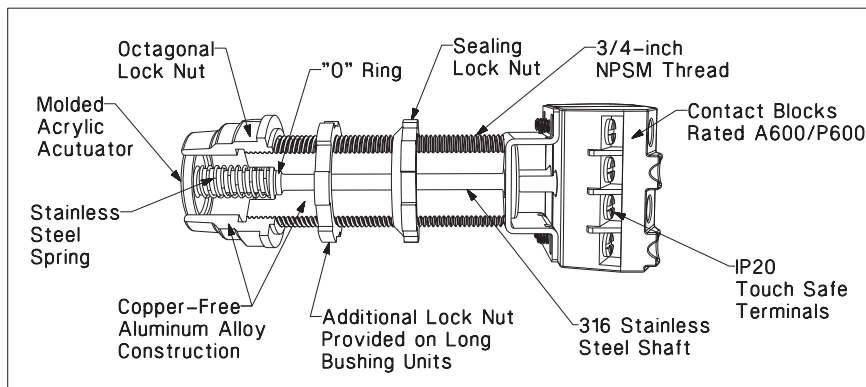

#### Panel Spacing

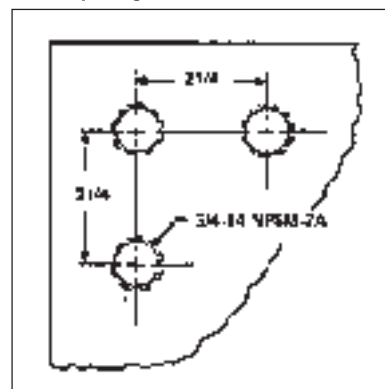





# Pushbutton Units and Indicator Lights

## Class 51, Hazardous Location NEMA Type 7 & 9 Devices

Operators only

### Selection and ordering data

	Version	Color of operator	Contacts	Short bushing Order No.	Long bushing Order No.	Pack Unit
Pushbutton with flat cap 	<b>Pushbutton with flush cap</b>	Black		<b>51PA8A1</b>	<b>51PA8A1LB</b>	1
		Red		<b>51PA8A2</b>	<b>51PA8A2LB</b>	1
		Green		<b>51PA8A3</b>	<b>51PA8A3LB</b>	1
Pushbutton with extended cap 	<b>Pushbutton with extended cap</b>	Black		<b>51PA8B1</b>	<b>51PA8B1LB</b>	1
		Red		<b>51PA8B2</b>	<b>51PA8B2LB</b>	1
		Green		<b>51PA8B3</b>	<b>51PA8B3LB</b>	1
Dual pushbutton 	<b>Dual Pushbutton</b>	Flush Black		<b>51PD8A1B2</b>	<b>51PD8A1B2LB</b>	1
		Raised Red				
	<b>Pushbutton with mushroom cap 1 5/8"(41.3mm)</b>	Black		<b>51PA9D1</b>	<b>51PA9D1LB</b>	1
		Red		<b>51PA9D2</b>	<b>51PA9D2LB</b>	1
		Green		<b>51PA9D3</b>	<b>51PA9D3LB</b>	1
	<b>Pushbutton with mushroom cap 2 1/2"(63.5mm)</b>	Black		<b>51PA9E1</b>	<b>51PA9E1LB</b>	1
		Red		<b>51PA9E2</b>	<b>51PA9E2LB</b>	1
		Green		<b>51PA9E3</b>	<b>51PA9E3LB</b>	1
		Less head		<b>51PA9</b>	<b>51PA9LB</b>	1
2 position push-pull 	<b>2 Position Push Pull Maintained, Non Illuminated</b> Small Plastic Mushroom Head, 1 5/8" (41.3 mm)	Black		<b>51PA2D1</b>	<b>51PA2D1LB</b>	1
		Red		<b>51PA2D2</b>	<b>51PA2D2LB</b>	1
		Green		<b>51PA2D3</b>	<b>51PA2D3LB</b>	1
	Large Plastic Mushroom Head, 2 1/4" (57.2 mm)	Black		<b>51PA2E1</b>	<b>51PA2E1LB</b>	1
		Red		<b>51PA2E2</b>	<b>51PA2E2LB</b>	1
		Green		<b>51PA2E3</b>	<b>51PA2E3LB</b>	1
		Less head		<b>51PA2</b>	<b>51PA2LB</b>	1
	<b>2 Position Push Pull Maintained, Non Illuminated</b> Small Mushroom Head, 1 5/8"(41.3mm)	Black	1NC + 1NO	<b>51PA2D1A</b>	<b>51PA2D1LBA</b>	1
		Red	1NC + 1NO	<b>51PA2D2A</b>	<b>51PA2D2LBA</b>	1
		Green	1NC + 1NO	<b>51PA2D3A</b>	<b>51PA2D3LBA</b>	1
Large Mushroom Head, 2 1/2"(63.5mm)	Black	1NC + 1NO	<b>51PA2E1A</b>	<b>51PA2E1LBA</b>	1	
	Red	1NC + 1NO	<b>51PA2E2A</b>	<b>51PA2E2LBA</b>	1	
	Green	1NC + 1NO	<b>51PA2E3A</b>	<b>51PA2E3LBA</b>	1	
3 position push-pull 	<b>3 Position Push Pull Momentary, Non Illuminated</b> Small Mushroom Head, 1 5/8"(41.3mm)	Black	1NC + 1NO	<b>51PA3A1U</b>	<b>51PA3A1ULB</b>	1
		Red	1NC + 1NO	<b>51PA3A2U</b>	<b>51PA3A2ULB</b>	1
		Green	1NC + 1NO	<b>51PA3A3U</b>	<b>51PA3A3ULB</b>	1



# Pushbutton Units and Indicator Lights

## Class 51, Hazardous Location NEMA Type 7 & 9 Devices

Indicator light

1  
2  
3  
4  
5  
6  
7  
8  
9  
10

### Selection and ordering data

Version	Color of operator	Contacts	Short bushing Order No.	Long bushing Order No.	Pack Unit		
 <p>Indicator light- full voltage</p>	<b>Indicator light with glass lens - Full voltage type AC/DC (with 6" pigtail leads) <sup>1) 3)</sup></b>						
	Operators with Incandescent Lamp 6-8V with 755 type	Red Green Amber Less lens		<b>51PC5B2</b> <b>51PC5B3</b> <b>51PC5B9</b> <b>51PC5BN</b>	<b>51PC5B2LB</b> <b>51PC5B3LB</b> <b>51PC5B9LB</b> <b>51PC5BNLB</b>	1	
	12V with 756 type	Red Green Amber Less lens		<b>51PC5C2</b> <b>51PC5C3</b> <b>51PC5C9</b> <b>51PC5CN</b>	<b>51PC5C2LB</b> <b>51PC5C3LB</b> <b>51PC5C9LB</b> <b>51PC5CNLB</b>	1	
	24V with 757 type	Red Green Amber Less lens		<b>51PC5D2</b> <b>51PC5D3</b> <b>51PC5D9</b> <b>51PC5DN</b>	<b>51PC5D2LB</b> <b>51PC5D3LB</b> <b>51PC5D9LB</b> <b>51PC5DNLB</b>	1	
	Operators with LED Lamp <sup>2)</sup> 6-8V with BA9 type LED	Red Green Amber		<b>51PE5B2</b> <b>51PE5B3</b> <b>51PE5B9</b>	<b>51PE5B2LB</b> <b>51PE5B3LB</b> <b>51PE5B9LB</b>	1	
	24V with BA9 type LED	Red Green Amber		<b>51PE5D2</b> <b>51PE5D3</b> <b>51PE5D9</b>	<b>51PE5D2LB</b> <b>51PE5D3LB</b> <b>51PE5D9LB</b>	1	
	 <p>Indicator light- transformer type</p>	<b>Indicator light with glass lens - Transformer type AC/DC <sup>1) 3)</sup></b>					
		Operators with Incandescent Lamp 120V with 6V 755 type lamp	Red Green Amber Less lens		<b>51PC5G2</b> <b>51PC5G3</b> <b>51PC5G9</b> <b>51PC5GN</b>	<b>51PC5G2LB</b> <b>51PC5G3LB</b> <b>51PC5G9LB</b> <b>51PC5GNLB</b>	1
		240V with 6V 755 type lamp	Red Green Amber Less lens		<b>51PC5H2</b> <b>51PC5H3</b> <b>51PC5H9</b> <b>51PC5HN</b>	<b>51PC5H2LB</b> <b>51PC5H3LB</b> <b>51PC5H9LB</b> <b>51PC5HNLB</b>	1
		480V with 6V 755 type lamp	Red Green Amber Less lens		<b>51PC5J2</b> <b>51PC5J3</b> <b>51PC5J9</b> <b>51PC5JN</b>	<b>51PC5J2LB</b> <b>51PC5J3LB</b> <b>51PC5J9LB</b> <b>51PC5JNLB</b>	1
		600V with 6V 755 type lamp	Red Green Amber Less lens		<b>51PC5K2</b> <b>51PC5K3</b> <b>51PC5K9</b> <b>51PC5KN</b>	<b>51PC5K2LB</b> <b>51PC5K3LB</b> <b>51PC5K9LB</b> <b>51PC5KNLB</b>	1
		Operators with LED Lamp <sup>2)</sup> 120V with 6V BA9 type LED	Red Green Amber Less lens		<b>51PE5G2</b> <b>51PE5G3</b> <b>51PE5G9</b> —	<b>51PE5G2LB</b> <b>51PE5G3LB</b> <b>51PE5G9LB</b> —	1
240V with 6V BA9 type LED		Red Green Amber Less lens		<b>51PE5H2</b> <b>51PE5H3</b> <b>51PE5H9</b> —	<b>51PE5H2LB</b> <b>51PE5H3LB</b> <b>51PE5H9LB</b> —	1	
480V with 6V BA9 type LED		Red Green Amber Less lens		<b>51PE5J2</b> <b>51PE5J3</b> <b>51PE5J9</b> —	<b>51PE5J3LB</b> <b>51PE5J3LB</b> <b>51PE5J9LB</b> —	1	
600V with 6V BA9 type LED		Red Green Amber Less lens		<b>51PE5K2</b> <b>51PE5K3</b> <b>51PE5K9</b> —	<b>51PE5K2LB</b> <b>51PE5K3LB</b> <b>51PE5K9LB</b> —	1	
<b>Indicator light with glass lens - Resistor type AC/DC*</b> 120V with 24V 757 type lamp		Red Green Amber Less lens		<b>51PC5M2</b> <b>51PC5M3</b> <b>51PC5M9</b> <b>51PC5MN</b>	<b>51PC5M2LB</b> <b>51PC5M3LB</b> <b>51PC5M9LB</b> <b>51PC5MNLB</b>	1	
		120V with 24V BA9 type LED lamp <sup>2)</sup>	Red Green Amber		<b>51PE5M2</b> <b>51PE5M3</b> <b>51PE5M9</b>	<b>51PE5M2LB</b> <b>51PE5M3LB</b> <b>51PE5M9LB</b>	1

1) For other colors not listed, order operator less lens and separate lens from page 10/127.

2) LED color must match lens color.

3) All illuminated devices come with std. Touch-safe shield per UL stds.





# Pushbutton Units and Indicator Lights



## Class 51, Hazardous Location NEMA Type 7 & 9 Devices

### Push to test complete units

#### Selection and ordering data

Version	Color of operator	Contacts	Short bushing Order No.	Long bushing Order No.	Pack Unit	
Push to test full voltage 	<b>Push to test/Illuminated pushbutton with glass lens - Full voltage type AC/DC <sup>1) 3)</sup></b>					
	Red	1NO + 1NC	<b>51PC6B2A</b>	<b>51PC6B2ALB</b>	1	
	Green	1NO + 1NC	<b>51PC6B3A</b>	<b>51PC6B3ALB</b>	1	
	Amber	1NO + 1NC	<b>51PC6B9A</b>	<b>51PC6B9ALB</b>	1	
	Less lens	1NO + 1NC	<b>51PC6BNA</b>	<b>51PC6BNALB</b>	1	
	24V with 757 type lamp	Red	1NO + 1NC	<b>51PC6D2A</b>	<b>51PC6D2ALB</b>	1
		Amber	1NO + 1NC	<b>51PC6D3A</b>	<b>51PC6D3ALB</b>	1
		Green	1NO + 1NC	<b>51PC6D9A</b>	<b>51PC6D9ALB</b>	1
		Less lens	1NO + 1NC	<b>51PC6DNA</b>	<b>51PC6DNALB</b>	1
	Operators with LED Lamp <sup>2)</sup> 6-8V with BA9 type LED	Red	1NO + 1NC	<b>51PE6B2A</b>	<b>51PE6B2ALB</b>	1
		Green	1NO + 1NC	<b>51PE6B3A</b>	<b>51PE6B3ALB</b>	1
		Amber	1NO + 1NC	<b>51PE6B9A</b>	<b>51PE6B9ALB</b>	1
24V with BA9 type LED	Red	1NO + 1NC	<b>51PE6D2A</b>	<b>51PE6D2ALB</b>	1	
	Green	1NO + 1NC	<b>51PE6D3A</b>	<b>51PE6D3ALB</b>	1	
	Amber	1NO + 1NC	<b>51PE6D9A</b>	<b>51PE6D9ALB</b>	1	
Push to test transformer type 	<b>Push to test/Illuminated pushbutton with glass lens - Transformer type (50/60 Hz) <sup>1) 3)</sup></b>					
	Red	1NO + 1NC	<b>51PC6G2A</b>	<b>51PC6G2ALB</b>	1	
	Green	1NO + 1NC	<b>51PC6G3A</b>	<b>51PC6G3ALB</b>	1	
	Amber	1NO + 1NC	<b>51PC6G9A</b>	<b>51PC6G9ALB</b>	1	
	Less lens	1NO + 1NC	<b>51PC6GNA</b>	<b>51PC6GNALB</b>	1	
	240V with 6V 755 type lamp	Red	1NO + 1NC	<b>51PC6H2A</b>	<b>51PC6H2ALB</b>	1
		Green	1NO + 1NC	<b>51PC6H3A</b>	<b>51PC6H3ALB</b>	1
		Amber	1NO + 1NC	<b>51PC6H9A</b>	<b>51PC6H9ALB</b>	1
		Less lens	1NO + 1NC	<b>51PC6HNA</b>	<b>51PC6HNALB</b>	1
	480V with 6V 755 type lamp	Red	1NO + 1NC	<b>51PC6J2A</b>	<b>51PC6J2ALB</b>	1
		Green	1NO + 1NC	<b>51PC6J3A</b>	<b>51PC6J3ALB</b>	1
		Amber	1NO + 1NC	<b>51PC6J9A</b>	<b>51PC6J9ALB</b>	1
		Less lens	1NO + 1NC	<b>51PC6JNA</b>	<b>51PC6JNALB</b>	1
	600V with 6V 755 type lamp	Red	1NO + 1NC	<b>51PC6K2A</b>	<b>51PC6K2ALB</b>	1
		Green	1NO + 1NC	<b>51PC6K3A</b>	<b>51PC6K3ALB</b>	1
		Amber	1NO + 1NC	<b>51PC6K9A</b>	<b>51PC6K9ALB</b>	1
		Less lens	1NO + 1NC	<b>51PC6KNA</b>	<b>51PC6KNALB</b>	1
	Operators with LED Lamp <sup>2)</sup> 120V with 6V BA9 type LED	Red	1NO + 1NC	<b>51PE6G2A</b>	<b>51PE6G2ALB</b>	1
		Green	1NO + 1NC	<b>51PE6G3A</b>	<b>51PE6G3ALB</b>	1
		Amber	1NO + 1NC	<b>51PE6G9A</b>	<b>51PE6G9ALB</b>	1
	240V with 6V BA9 type LED	Red	1NO + 1NC	<b>51PE6H2A</b>	<b>51PE6H2ALB</b>	1
		Green	1NO + 1NC	<b>51PE6H3A</b>	<b>51PE6H3ALB</b>	1
		Amber	1NO + 1NC	<b>51PE6H9A</b>	<b>51PE6H9ALB</b>	1
	480V with 6V BA9 type LED	Red	1NO + 1NC	<b>51PE6J2A</b>	<b>51PE6J2ALB</b>	1
	Green	1NO + 1NC	<b>51PE6J3A</b>	<b>51PE6J3ALB</b>	1	
	Amber	1NO + 1NC	<b>51PE6J9A</b>	<b>51PE6J9ALB</b>	1	
600V with 6V BA9 type LED	Red	1NO + 1NC	<b>51PE6K2A</b>	<b>51PE6K2ALB</b>	1	
	Green	1NO + 1NC	<b>51PE6K3A</b>	<b>51PE6K3ALB</b>	1	
	Amber	1NO + 1NC	<b>51PE6K9A</b>	<b>51PE6K9ALB</b>	1	

### Overload reset operators with reset legend plate

Version	Color	Legend Inscription	Order No.
 Single unit 7/8" diameter reset pad, 10" shaft can be cut to length.	Red	Reset	<b>51AAS</b>
 Multi unit For use with multi push operation requirements.	Red	Reset	<b>51AAM</b>

1) For other colors not listed, order operator less lens and separate lens from page 10/127.

2) LED color must match lens color.

3) All illuminated devices come with std. Touch-safe shield per UL stds.





# Pushbutton Units and Indicator Lights

## Class 51, Hazardous Location NEMA Type 7 & 9 Devices

### Selector switch operators

1  
2  
3  
4  
5  
6  
7  
8  
9  
10

#### Selection and ordering data

Version	Lever type	Color of insert	Cam Code 1) 2)	Short bushing Order No.	Long bushing Order No.	Pack Unit		
	Short lever, non-Illuminated	White	A	<b>51SA2AA</b>	<b>51SA2AALB</b>	1		
	Long lever, non-Illuminated	White	A	<b>51SB2AA</b>	<b>51SB2AALB</b>			
Maintained operation	Short lever, non-Illuminated	White	A	<b>51SA2AC</b>	<b>51SA2ACLB</b>	1		
	Long lever, non-Illuminated	White	A	<b>51SB2AC</b>	<b>51SB2ACLB</b>			
	Short lever, non-Illuminated	White	B	<b>51SA2BA</b>	<b>51SA2BALB</b>	1		
	Long lever, non-Illuminated	White	B	<b>51SB2BA</b>	<b>51SB2BALB</b>			
Maintained operation	Short lever, non-Illuminated	White	C	<b>51SA2CA</b>	<b>51SA2CALB</b>	1		
	Long lever, non-Illuminated	White	C	<b>51SB2CA</b>	<b>51SB2CALB</b>			
	Short lever, non-Illuminated	White	D	<b>51SA2DA</b>	<b>51SA2DALB</b>			
	Long lever, non-Illuminated	White	D	<b>51SB2DA</b>	<b>51SB2DALB</b>			
	Short lever, non-Illuminated	White	E	<b>51SA2EA</b>	<b>51SA2EALB</b>			
	Long lever, non-Illuminated	White	E	<b>51SB2EA</b>	<b>51SB2EALB</b>			
	Short lever, non-Illuminated	White	G	<b>51SA2GA</b>	<b>51SA2GALB</b>			
	Long lever, non-Illuminated	White	G	<b>51SB2GA</b>	<b>51SB2GALB</b>			
	Spring return from right operation	Short lever, non-Illuminated	White	B	<b>51SA2BC</b>		<b>51SA2BCLB</b>	1
		Long lever, non-Illuminated	White	B	<b>51SB2BC</b>		<b>51SB2BCLB</b>	
Short lever, non-Illuminated		White	C	<b>51SA2CC</b>	<b>51SA2CCLB</b>			
Long lever, non-Illuminated		White	C	<b>51SB2CC</b>	<b>51SB2CCLB</b>			
Short lever, non-Illuminated		White	D	<b>51SA2DC</b>	<b>51SA2DCLB</b>			
Long lever, non-Illuminated		White	D	<b>51SB2DC</b>	<b>51SB2DCLB</b>			
Short lever, non-Illuminated		White	E	<b>51SA2EC</b>	<b>51SA2ECLB</b>			
Long lever, non-Illuminated		White	E	<b>51SB2EC</b>	<b>51SB2ECLB</b>			
Short lever, non-Illuminated		White	G	<b>51SA2GC</b>	<b>51SA2GCLB</b>			
Long lever, non-Illuminated		White	G	<b>51SB2GC</b>	<b>51SB2GCLB</b>			
Spring return from left operation	Short lever, non-Illuminated	White	B	<b>51SA2BB</b>	<b>51SA2BBLB</b>	1		
	Long lever, non-Illuminated	White	B	<b>51SB2BB</b>	<b>51SB2BBLB</b>			
	Short lever, non-Illuminated	White	C	<b>51SA2CB</b>	<b>51SA2CBLB</b>			
	Long lever, non-Illuminated	White	C	<b>51SB2CB</b>	<b>51SB2CBLB</b>			
	Short lever, non-Illuminated	White	D	<b>51SA2DB</b>	<b>51SA2DBLB</b>			
	Long lever, non-Illuminated	White	D	<b>51SB2DB</b>	<b>51SB2DBLB</b>			
	Short lever, non-Illuminated	White	E	<b>51SA2EB</b>	<b>51SA2EBLB</b>			
	Long lever, non-Illuminated	White	E	<b>51SB2EB</b>	<b>51SB2EBLB</b>			
	Short lever, non-Illuminated	White	G	<b>51SA2GB</b>	<b>51SA2GBLB</b>			
	Long lever, non-Illuminated	White	G	<b>51SB2GB</b>	<b>51SB2GBLB</b>			
Spring return from left and right operation	Short lever, non-Illuminated	White	B	<b>51SA2BD</b>	<b>51SA2BDLB</b>	1		
	Long lever, non-Illuminated	White	B	<b>51SB2BD</b>	<b>51SB2BDLB</b>			
	Short lever, non-Illuminated	White	C	<b>51SA2CD</b>	<b>51SA2CDLB</b>			
	Long lever, non-Illuminated	White	C	<b>51SB2CD</b>	<b>51SB2CDLB</b>			
	Short lever, non-Illuminated	White	D	<b>51SA2DD</b>	<b>51SA2DDLb</b>			
	Long lever, non-Illuminated	White	D	<b>51SB2DD</b>	<b>51SB2DDLb</b>			
	Short lever, non-Illuminated	White	E	<b>51SA2ED</b>	<b>51SA2EDLB</b>			
	Long lever, non-Illuminated	White	E	<b>51SB2ED</b>	<b>51SB2EDLB</b>			
	Short lever, non-Illuminated	White	G	<b>51SA2GD</b>	<b>51SA2GDLB</b>			
	Long lever, non-Illuminated	White	G	<b>51SB2GD</b>	<b>51SB2GDLB</b>			

1)C CAM limited to 4 single or double pole blocks on spring return operators.

2)For contact operation, see CAM selection chart on [page 10/179](#).

# Pushbutton Units and Indicator Lights

## Class 51, Hazardous Location NEMA Type 7 & 9 Devices

### Selector switch operators

#### Selection and ordering data



Version	Key removal position	Lock number	CAM Code 1) 2)	Short bushing Order No.	Long bushing Order No.	Pack Unit	
<b>Key-operated selector switches with 2 switching positions</b>	Both	550CH	A	51SA6AE	51SA6AELB	1	
	Left	550CH	A	51SA6AF	51SA6AFLB		
Maintained operation							
Spring return from right operation	Left	550CH	A	51SA6AC	51SA6ACLB	1	
<b>Key-operated selector switches with 3 switching positions</b>	All	550CH	B	51SA6BE	51SA6BELB	1	
			C	51SA6CE	51SA6CELB		
Maintained operation							
Left	550CH	B	D	51SA6DE	51SA6DELB	1	
			E	51SA6EE	51SA6EELB		
			G	51SA6GE	51SA6GELB		
			C	51SA6CF	51SA6CFLB		
Right	550CH	B	D	51SA6DF	51SA6DFLB	1	
			E	51SA6EF	51SA6EFLB		
			G	51SA6GF	51SA6GFLB		
			C	51SA6CG	51SA6CGLB		
Center	550CH	B	D	51SA6DG	51SA6DGLB	1	
			E	51SA6EG	51SA6EGLB		
			G	51SA6GG	51SA6GGLB		
			C	51SA6CH	51SA6CHLB		
Left and Center	550CH	B	D	51SA6DH	51SA6DHLB	1	
			E	51SA6EH	51SA6EHLB		
			G	51SA6GH	51SA6GHLB		
			C	51SA6CK	51SA6CKLB		
Spring return from right operation	Center	550CH	D	51SA6DK	51SA6DKLB	1	
			E	51SA6EK	51SA6EKLb		
			G	51SA6GK	51SA6GKLB		
			C	51SA6CU	51SA6CULB		
Spring return from left operation	Center	550CH	D	51SA6DU	51SA6DULB	1	
			E	51SA6EU	51SA6EULB		
			G	51SA6GU	51SA6GULB		
			C	51SA6CT	51SA6CTLB		
Spring return from left and right operation	Center	550CH	D	51SA6DT	51SA6DTLB	1	
			E	51SA6ET	51SA6ETLB		
			G	51SA6GT	51SA6GTLB		
			C	51SA6CV	51SA6CVLB		
To order 1 to 25 special locks for keyed selector switches simply replace the 6 in the 5th digit of the catalog number with a 5 when entering your order. (Ordering Example: 52SC6AE is changed to 52SC5AE and all locks - up to				B	51SA6BV	51SA6BVLB	1
				C	51SA6CV	51SA6CVLB	
				D	51SA6DV	51SA6DVLB	
				E	51SA6EV	51SA6EVLB	
				G	51SA6GV	51SA6GVLB	

5

5

**To order special locks for keyed selector switches, append corresponding 'X' suffix to part number**

Ordering example:  
51SA6AEX298

#549CH	X639		1
#548CH	X640		1
#547CH	X641		1
#501CH	X642		1
#506CH	X643		1

1) CAM limited to 4 single or double pole blocks on spring return operators.

2) For contact operation, see CAM selection chart on [page 10/179](#).

# Pushbutton Units and Indicator Lights

## Class 51, Hazardous Location NEMA Type 7 & 9 Devices

Cam selection

1

2

3

4

5

6

7

8

9

10

### Selection and ordering data

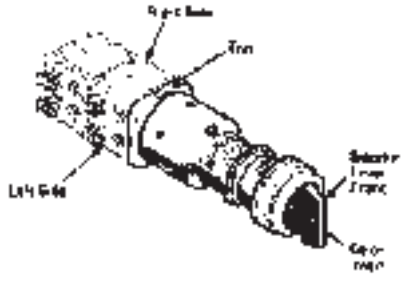
Design	Ordering Information
	<ul style="list-style-type: none"> <li>Contact blocks are ordered separately, <a href="#">see page 10/182</a>.</li> <li>Determine which table to use based upon the type of selector (non-illuminated &amp; keyed on top, illuminated on bottom).</li> <li>Find the correct number of selector positions (2, 3 or 4 positions).</li> <li>Select the contact operation required for each selector position. X indicates the contacts are closed, while O indicates the contacts are open. (For the selector pushbutton, N=normal and D=depressed). Contact block must be assembled in position shown for each circuit application.</li> <li>Identify the CAM letter required for the chosen contact operation (only 1 CAM can be used per selector switch or selector pushbutton).</li> <li>Contact blocks must be assembled in the position shown for each circuit application. The mounting position is viewed from the front of the device.</li> </ul> <p><b>Ordering CAMs D, E or G</b></p> <ul style="list-style-type: none"> <li>CAM D, E or G may be ordered at the same price by changing the 6th character of the selector catalog number. Example: Selector with D cam <b>51SA2DA</b>.</li> </ul> <p><b>Size Requirements</b></p> <ul style="list-style-type: none"> <li>C CAM on spring return selectors is limited to 4 contact blocks. Standard push buttons accept 4 contact blocks on each side, for a maximum of 8 contact blocks.</li> <li>Selector operators in enclosures are limited to depth of 1 contact block. (2 blocks wide).</li> </ul>

### Non-illuminated and keyed selector switches (viewed from front)

2 Selector Positions			Contact Blocks	CAM	Mounting	
Left	Right				Left	Right
X	O		52BAJ (NC)	A	L	R
O	X		52BAK (NO)	A	L	R
3 Selector Positions			Contact Blocks	CAM	Mounting	
Left	Center	Right			Left	Right
X	O	O	52BAK (NO)	B		R
O	O	X	52BAK (NO)	B	L	
X	X	O	52BAJ (NC)	B	L	
O	X	X	52BAJ (NC)	B	R	
O	O	X	52BAK (NO)	C	L	R
X	O	O	52BAJ (NC)	C	L	R
O	O	X	52BAK (NO)	D	L	R
O	X	O	52BAJ (NC)	D	L	R
X	O	O	52BAK (NO)	E	L	R
O	X	O	52BAJ (NC)	E	L	R
X	O	O	52BAJ (NC)	G	L	
O	X	O	52BAJ (NC)	G		R
O	O	X	52BAK (NO)	G	L	R

### Illuminated selector switches

2 Selector Positions			Contact Blocks	CAM	Mounting	
Left	Right				Left	Right
X	O		52BAJ (NC)	A	L	
O	X		52BAK (NO)	A	L	





1) Wired in parallel.

# Pushbutton Units and Indicator Lights

## Class 51, Hazardous Location NEMA Type 7 & 9 Devices

### Control stations

#### Selection and ordering data

	Operator Identification <sup>1)</sup>	Degree of operator	Contacts/voltage	Number of command points	Order No.	Pack Unit
	A = Momentary flush pushbutton black, label "START"	NEMA 7/9	1NO - 1NC	1	51C101H	1
	A = Momentary raised pushbutton red, label "STOP"	NEMA 7/9	1NO - 1NC	1	51C103H	1
	A = Momentary 1 5/8" mushroom head red label "STOP"	NEMA 7/9	1NO - 1NC	1	51C104H	1
	A = Momentary dual pushbutton red label "START, STOP"	NEMA 7/9	1NO - 1NC	1	51C105H	1
	A = 2 position selector switch label "Off-On"	NEMA 7/9	1NO - 1NC	1	51C159H	1
	A = 3 position selector switch label "HAND-OFF-AUTO"	NEMA 7/9	1NO - 1NC	1	51C156H	1
	A = Indicator light, green, 120 V	NEMA 7/9		1	51C131H	1
	A = Indicator light, red, 120 V	NEMA 7/9		1	51C135H	1
	B = Momentary flush pushbutton black, label "START" A = Momentary raised pushbutton red, label "STOP"	NEMA 7/9	1NO - 1NC 1NO - 1NC	2	51C201H	1
	B = Momentary flush pushbutton black, label "FORWARD" A = Momentary flush pushbutton red, label "REV"	NEMA 7/9	1NO - 1NC 1NO - 1NC	2	51C204H	1
	B = Momentary flush pushbutton black, label "START" A = Momentary 1 5/8" mushroom head pushbutton red, label "STOP"	NEMA 7/9	1NO - 1NC 1NO - 1NC	2	51C202H	1
	B = Indicator light, red, 120 V A = Indicator light, green, 120 V	NEMA 7/9	1NO - 1NC 1NO - 1NC	2	51C230H	1
	C = Momentary flush pushbutton black, label "FORWARD" B = Momentary flush pushbutton black, label "REVERSE" A = Momentary raised pushbutton red, label "STOP"	NEMA 7/9	1NO - 1NC 1NO - 1NC 1NO - 1NC	3	51C301H	1
	C = Momentary flush pushbutton black, label "OPEN" B = Momentary flush pushbutton black, label "CLOSE" A = Momentary raised pushbutton red, label "STOP"	NEMA 7/9	1NO - 1NC 1NO - 1NC 1NO - 1NC	3	51C303H	1
	C = Indicator light, green, 120 V B = Momentary flush pushbutton black, label "START" A = Momentary raised pushbutton red, label "STOP"	NEMA 7/9	1NO - 1NC 1NO - 1NC	3	51C307H	1
<b>Enclosures only<sup>2)</sup></b>						
	For field assembly of Type 7 & 9 UL listed and cUL listed control stations. Devices may be installed for either horizontal or vertical mounting using a standard legend. Limited to depth of 1 contact block.			1	51EA1H	1
				2	51EA2H	1
				3	51EA3H	1

1) All enclosures come standard with one conduit entry on top. To get two conduit entries, append X-311 to the end of the order number.

2) For legend plates see page 10/218.











# Pushbutton Units and Indicator Lights

## Class 51, Hazardous Location NEMA Type 7 & 9 Devices

### Accessories and spare parts

1  
2  
3  
4  
5  
6  
7  
8  
9  
10

#### Selection and ordering data

Version	Suitable for	Conduit size (in.)	Color	Order No.	Pack Unit
	For small 1 5/8" (41.3mm) type, non-illuminated mushroom push-buttons		Black	52RB3D1	1
			Red	52RB3D2	
			Green	52RB3D3	
			Yellow	52RB3D4	
			Blue	52RB3D5	
			Gray	52RB3D6	
			Orange	52RB3D8	
			1 kit of each	52RB3DN	
				For large 2 1/2" (63.5mm) type, non-illuminated mushroom push-buttons	
Red	52RB3E2				
Green	52RB3E3				
Yellow	52RB3E4				
Blue	52RB3E5				
Gray	52RB3E6				
Orange	52RB3E8				
1 kit of each	52RB3EN				
	Replacement lens for pilot lights				Red
			Green	51RC4G3	
			Blue	51RC4G5	
			Amber	51RC4G9	
			Clear	51RC4GA	
	Replacement lens for push to test/illuminated pushbuttons		Red	51RC5G2	1
			Green	51RC5G3	
			Amber	51RC5G9	
	Guards		Chrome	51AAGM	1
Prevents accidental operation	Non-illuminated Pushbuttons & Push Pull Operators with Mushroom Head Caps 1 5/8" to 1 3/4" in diameter.				
	Lever inserts		Red	52RA2A2	1
			Green	52RA2A3	
			Blue	52RA2A4	
			Amber	52RA2A5	
			Gray	52RA2A6	
			Orange	52RA2A8	
			White	52RA2AB	
	Long lever		Red	52RA2B2	1
			Green	52RA2B3	
			Blue	52RA2B4	
			Amber	52RA2B5	
			Gray	52RA2B6	
			Orange	52RA2B8	
			White	52RA2BB	
	Padlock attachment	Only for raised pushbutton operators		51AAL	1
	Breather/drain (Stainless Steel)	Installs in bottom as a drain or in the top as a breather. Suitable for Class 1 groups C & D and for Class 2 groups F & G applications only. Fits 1/2" NPT.		51AADB	1
	Lock nut wrench	All devices		52MAWB	1
	Spare keys	550CH (1 key)		52KEY-550CH	1

# Pushbutton Units and Indicator Lights

## Class 51, Hazardous Location NEMA Type 7 & 9 Devices

### Accessories and spare parts

#### Selection and ordering data

Version	Suitable for	Conduit size (in.)	Color	Order No.	Pack Unit			
<b>Reducer bushings</b>	Cast aluminum, UL recognized and CSA certified. Used to reduce existing tapered NPT conduit opening when required.	3/4 - 1/2		<b>51AARBA</b>	1			
		1 - 1/2		<b>51AARCA</b>				
		1 1/2 - 3/4		<b>51AARDB</b>				
		1 1/2 - 1		<b>51AARDC</b>				
		2 1/2 - 3/4		<b>51AARFB</b>				
		2 1/2 - 1		<b>51AARFC</b>				
		2 1/2 - 1 1/2		<b>51AARFD</b>				
		2 1/2 - 2		<b>51AARFE</b>				
		3 - 1		<b>51AARGC</b>				
		3 - 1 1/2		<b>51AARGD</b>				
		3 - 2		<b>51AARGE</b>				
		3 - 2 1/2		<b>51AARGF</b>				
		<b>Lamps with screw connection, miniature bayonet incandescent lamps</b>						
		Flashing, type 267 lamp (replaces 755 lamp)	51, 52	6V	<b>52AABNF</b>	1		
		6V Full voltage, transformer type 755 lamp	51, 52	6V	<b>52AABN</b>	1		
		12V full voltage, type 756	51, 52	12V	<b>52AACN</b>	1		
		24V full voltage, 120/240V resistor push-to-test type 757	51, 52	24V	<b>52AADN</b>	1		
		Neon (uses resistors) type B2A (NE-51H)	51, 52	120V	<b>52AAPN</b>	1		
		120V, full voltage type 3S6/5	51, 52	120V	<b>52AAENC</b>	1		
		LEDs, Single element		51, 52	6V	Red	<b>52AEB2</b>	1
				51, 52	6V	Green	<b>52AEB3</b>	
				51, 52	6V	Yellow	<b>52AEB4</b>	
				51, 52	6V	White	<b>52AEBB</b>	
				51, 52	6V	Blue	<b>52AEB5</b>	
				51, 52	24V	Red	<b>52AED2</b>	
				51, 52	24V	Green	<b>52AED3</b>	
51, 52	24V			Yellow	<b>52AED4</b>			
51, 52	24V			White	<b>52AEDB</b>			
51, 52	24V			Blue	<b>52AED5</b>			
51, 52	120V	Red	<b>52AEE2</b>					
51, 52	120V	Green	<b>52AEE3</b>					
51, 52	120V	Yellow	<b>52AEE4</b>					
51, 52	120V	White	<b>52AEEB</b>					
51, 52	120V	Blue	<b>52AEE5</b>					

# Pushbutton Units and Indicator Lights

## Class 51, Hazardous Location NEMA Type 7 & 9 Devices

### Accessories and spare parts

1

2

3

4

5

6



7

8

9

10

#### Selection and ordering data

	Version	Suitable for	Conduit size (in.)	Color	Order No.	Pack Unit
	52BAJ					
	52BAK					
	52BAR					
	<b>Touchsafe contact blocks with gold flashing</b>					
	1 NO				<b>52BAK</b>	1
	1 NC				<b>52BAJ</b> <sup>②</sup>	
	1 NO - 1 NC				<b>52BJK</b> <sup>②</sup>	
	1 NO early make	closes before 52BAK			<b>52BAH</b>	
	1 NC late break	opens after 52BAJ			<b>52BAE</b>	
	1 NO - 1 NC	Reed switch			<b>52BAR</b> <sup>①</sup>	
		UL listed for class 1 division 2				
		.25A Max, 200V AC, 10 Watt max				
		.5A Max, 200V DC, 10 Watt max				
	1 NC extra late break				<b>52BAU</b>	

① Hermetically sealed.

②  Positive opening according to IEC 60947-5-1, Appendix K.



# Pushbutton Units and Indicator Lights

## 30 mm Heavy Duty, Watertight/Oiltight, Class 52

### Pushbutton complete units

#### Features

- Octagonal Mounting Nuts
- Meets Type 1, 3, 3R, 4, 4X, 12, 13 and Automotive Standards
- Heavy Duty Rated NEMA A600/P600 Contacts
-  Positively Driven Contacts
- Positive Indexing Selectors
- Bifurcated Movable Contacts
- Attractive Chrome Plating
- Boots Not Required for Type 4
- UL Listed File # E22655
- CSA Certified File # LR6535
- Touchsafe Terminals

#### Application

Oil tight pilot controls and accessories are designed to provide long, trouble free service in the most demanding industrial applications. These controls are oil and dust tight and meet Type 3, 4, 4X, 12 and 13 specifications.

#### Rugged

Industrial control operators are durable one piece castings. Heavy duty plastic buttons resist oils and corrosion. Silver contacts carry heavy duty ratings.

#### Flexible

Accessories modify standard push buttons, selector switches and pilot lights. Building block construction of contact blocks makes possible many circuitry combinations.

#### Industrial Appearance

Pilot controls add luster to panels. Chrome plating covers exposed metal parts.

#### Push Button Operators

The Operator Base consists of a durable, one piece casting equipped with a heavy duty actuator with a stainless steel spring, a neoprene actuator sealing ring to prevent oil and dust from penetrating to the contact blocks, a neoprene gasket to seal operator mounting hole and a chrome plated lock nut.

#### Mushroom Head Push Button Operators

The Mushroom Head base construction is identical to the push button base. The actuator is molded of high impact material for either a 1 5/8 inch or 2 1/2 inch diameter molded head.

E-STOP Mushroom Head Operators according to EN 60947-5-5 Cat. No. 52BP, 52BR, 52PP, and 52PR, 2 Position, Twist-To-Release & 2 Position, Push Pull Maintained operators provided with red operating heads and 52BJK contact blocks meet the requirements of EN 60947-5-5 for Electrical Emergency Stop Device With Mechanical Latching Function (e-stop).

#### Contact Blocks

Contact Blocks have double break bifurcated silver contacts, with gold flashing as standard, which improves contact reliability. Contact blocks are heavy duty rated NEMA A600 and suitable for applications down to 5V/1MA solid state outputs. 52BJK offers  Positive Opening Contacts according to IEC 60947-5-1, Appendix K. Molded bodies and pushers resist arcing and tracking. All units have stainless steel springs that resist corrosion and provide strong contact pressure. Captive mounting screws speed panel assembly.

#### Push Pull Operators

Push Pull Operators combine two or three functions in one unit. The maintained operator has two positions, typically pull to start, push to stop. The momentary operator with three positions provides spring return from both pull and push positions. In addition, a three position push maintained, pull momentary operator is available. The actuator come is 1 3/4 inch or 2 1/2 inch diameter and is available in an illuminated version.

#### 2 Button Maintained Operator

Maintained Push Buttons consist of two push buttons and a latching assembly. When actuated the button remains depressed and is freed only by the release operator to which it is linked. The button assembly adjusts for mounting from a 1 13/16 inch to a 2 5/8 inch center.

#### Transformer Type Pilot Lights

Transformer Type Pilot Lights are available with a 120, 240, 480 or 600 Volt primary (50/60 Hertz) and a separate secondary winding which supplies reduced voltage to a miniature bayonet base 6 Volt lamp. These units are suitable for applications where vibration is present and long bulb life is desirable.

#### Full Voltage Type Pilot Lights

Full Voltage Pilot Lights are available for 6, 12, 24 and 120 Volt AC and DC applications.

#### Electrical Ratings

NEMA AC Ratings 50/60Hz

NEMA A600 10 Continuous Amps

Volts	Make	Break
120	60	6
240	30	3
480	15	1.5
600	12	1.2
VA	7200	720

#### Ordering Information

- Accessories: [pages 10/207 – 10/210](#)
- Selector Position and Contact Operation: [page 10/205 – 10/206](#).
- Legend Plates: [page 10/218](#).
- Enclosures: [page 10/219](#).
- Technical Specifications: [page 10/220](#).

#### Resistor Type Pilot Lights

Resistor Type Pilot Lights are available for 240 Volt AC and DC applications. The 240 Volt pilot light is supplied with a 120 Volt lamp and a voltage dropping resistor.

#### LED Type Pilot Lights

LED's (light emitting diodes) can be used in pilot lights instead of incandescent bulbs because of their long life (up to 10 years), resistance to vibration and ambient sensitivity. Clusted LED options are available for standard pilot lights only. Cluster LED options are not available on Push to test Pilot Lights, Illuminated Pushbuttons, Push-pull, or Twist-to-Release Operators.

#### Integrated LED Module Type Pilot Lights

The integrated LED module is available for 24, 120, and 240 V. LED modules are vibration resistant and have a long life (up to 10 years). The integrated LED module is available for 24, 120, and 240 V. LED modules are vibration resistant and have a long life (up to 10 yrs.).

#### Selector Operators

Selector Operators have positive action indexing. Operators are available with either a short or long lever. The molded black lever is designed to accept a color insert. A white insert is provided as standard. Each operator is equipped with a cam to actuate plungers of contact blocks assembled behind the operator. Two, three and four position operators are available with seven different cams.

Lever color inserts are available in 8 colors.



Indicator Light



Push Button



Selector Switch



Selector Push Button



• Revised •  
08/15/14

# Push Buttons & Signaling Devices

## 30mm Water, Oil Tight & Corrosion Resistant – Class 52

Push Button

1  
2  
3  
4  
5  
6  
7  
8  
9  
10

### Selection Guide

#### Momentary Push Button - Non-Illuminated



Flush Head



Extended Head



Large Mushroom Head 2 1/2"



Small Mushroom Head 1 3/4"

<b>Part Number</b>	<b>52</b>	<b>a</b>	<b>M</b> <b>b</b>	<b>c</b>	<b>d</b>	<b>e<sup>1</sup></b>
--------------------	-----------	----------	----------------------	----------	----------	----------------------

<b>a</b>	<b>Code</b>	<b>Finish</b>
	<b>P</b>	Chrome - Command 52
	<b>B</b>	Epoxy Coated - Black Max

<b>b</b>	<b>Code</b>	<b>Type</b>
	<b>M</b>	Momentary Push Button

<b>c</b>	<b>Code</b>	<b>Style / Head Type</b>
	<b>Flush / Extended Cap<sup>2</sup></b>	
	<b>8A</b>	Flush
	<b>8B</b>	Extended
	<b>Mushroom Head Metal</b>	
	<b>9A</b>	Small Mushroom Head 1 3/4" (44.5mm)
	<b>Mushroom Head Plastic</b>	
	<b>9W</b>	Small Mushroom Head 1 3/4" (44.5mm)
	<b>9V</b>	Large Mushroom Head 2 1/2" (63.5mm)

<b>d</b>	<b>Code</b>	<b>Plastic</b>	<b>Metal</b>
	<b>1</b>	Black	—
	<b>2</b>	Red	Red
	<b>3</b>	Green	Green
	<b>4</b>	Yellow	—
	<b>5</b>	Blue	—
	<b>6</b>	Gray	—
	<b>7</b>	All Color Caps	—
	<b>8</b>	Orange	—
<b>C</b>	—	Chrome	

<b>e<sup>1</sup></b>	<b>Code</b>	<b>Contact Blocks</b>
	<b>A</b>	1 NO + 1 NC
	<b>B</b>	2 NO + 2 NC
	<b>C</b>	3 NO + 3 NC
	<b>D</b>	4 NO + 4 NC
	<b>E</b>	1 NC (LB)
	<b>F</b>	2 NO
	<b>G</b>	2 NC
	<b>H</b>	1NO (EM)
	<b>J</b>	1 NC
	<b>K</b>	1 NO

<sup>1</sup> For operator without contact blocks leave position e blank.

<sup>2</sup> Products available fall 2014. For current product offer please refer to the 2010 Industrial Control Catalog.

# Push Buttons & Signaling Devices

## 30mm Water, Oil Tight & Corrosion Resistant – Class 52

### Push Buttons

#### Selection Tables

#### Momentary Push Button - Non-Illuminated

Head Style	Contacts	Color	Finish		
			Chrome	Black Max	
Flush	—	Less cap	<b>52PM8</b>	<b>52BM8</b>	
		Black	<b>52PM8A1</b>	<b>52BM8A1</b>	
		Red	<b>52PM8A2</b>	<b>52BM8A2</b>	
		Green	<b>52PM8A3</b>	<b>52BM8A3</b>	
		Yellow	<b>52PM8A4</b>	<b>52BM8A4</b>	
	1 NO - 1 NC	Black	<b>52PM8A1A</b>	<b>52BM8A1A</b>	
		Red	<b>52PM8A2A</b>	<b>52BM8A2A</b>	
		Green	<b>52PM8A3A</b>	<b>52BM8A3A</b>	
	1 NO	Black	<b>52PM8A1K</b>	<b>52BM8A1K</b>	
		Red	<b>52PM8A2K</b>	<b>52BM8A2K</b>	
		Green	<b>52PM8A3K</b>	<b>52BM8A3K</b>	
	1 NC	Red	<b>52PM8A2J</b>	<b>52BM8A2J</b>	
	Extended	—	Black	<b>52PM8B1</b>	<b>52BM8B1</b>
			Red	<b>52PM8B2</b>	<b>52BM8B2</b>
			Green	<b>52PM8B3</b>	<b>52BM8B3</b>
1 NO		Black	<b>52PM8B1K</b>	<b>52BM8B1K</b>	
		Red	<b>52PM8B2K</b>	<b>52BM8B2K</b>	
1 NC		Red	<b>52PM8B2J</b>	<b>52BM8B2J</b>	
Mushroom Head Plastic Ø 1 3/4"	—	Less cap	<b>52PM9</b>	<b>52BM9</b>	
		Red	<b>52PM9W2</b>	<b>52BM9W2</b>	
	1 NO	Green	<b>52PM9W3K</b>	<b>52BM9W3K</b>	
	1 NO - 1 NC	Black	<b>52PM9W1A</b>	<b>52BM9W1A</b>	
		Red	<b>52PM9W2A</b>	<b>52BM9W2A</b>	
	1 NO - 1 NC	Green	<b>52PM9W3A</b>	<b>52BM9W3A</b>	
Mushroom Head Plastic Ø 2 1/2"	—	Red	<b>52PM9V2</b>	<b>52BM9V2</b>	
		Black	<b>52PM9V1A</b>	<b>52BM9V1A</b>	
	1 NO - 1 NC	Red	<b>52PM9V2A</b>	<b>52BM9V2A</b>	
		Green	<b>52PM9V3A</b>	<b>52BM9V3A</b>	

Readily available items are in **bold**.  
This is a small representation of stocked items.

# Push Buttons & Signaling Devices

## 30mm Water, Oil Tight & Corrosion Resistant – Class 52

Non-Illuminated Push Pull

1

2

3

4

5

6

7

8

9

10

### Selection Guide

#### 2 & 3 Position Push-Pull Mushroom Head Devices - Non-Illuminated



Mushroom Head Metal Ø 1 3/4"



Mushroom Head Plastic Ø 2 1/2"



Mushroom Head Plastic Ø 1 3/4"

Part Number	<b>52</b>	<u>    </u>	<b>P</b>	<u>    </u>	<u>    </u>	<u>    </u>	<u>    </u>
		<b>a</b>	<b>b</b>	<b>c</b>	<b>d</b>	<b>e</b>	<b>f<sup>3</sup></b>

<b>a</b>	Code	Finish
	P	Chrome-Command 52
	B	Epoxy Coated-Black Max

<b>b</b>	Code	Type
	P	Push Pull

<b>c</b>	Code	Function
	2	2 positions - maintained <sup>1</sup>
	3	3 positions - momentary in - momentary out
	7	3 positions - maintained in - momentary out

<b>d</b>	Code	Style
	A	Small metal 1-3/4" (44.5 mm)
	W	Small plastic 1-3/4" (44.5 mm)
	V	Large plastic 2-1/2" (63.5 mm)

<b>e</b>	Code	Color	
		Plastic	Metal
	1	Black	—
	2	Red <sup>1</sup>	Red <sup>1</sup>
	3	Green	Green
	4	Yellow	—
	5	Blue	—
	6	Gray	—
	8	Orange	—
	C	—	Chrome
		No Operating Head	
	Z	No head	

<b>f<sup>3</sup></b>	Code	Contact Blocks
		2 Position
	A	1 NO + 1 NC <sup>1</sup>
	B	2 NO + 2 NC <sup>1</sup>
	C	3 NO + 3 NC <sup>1</sup>
	D	4 NO + 4 NC <sup>1</sup>
	E	1 NC (LB)
	F	2 NO
	G	2 NC <sup>1</sup>
	H	1 NO (EM)
	J	1 NC <sup>1</sup>
	K	1 NO
	Q	1 NO - 1 NC (ELB)
		3 Position
U	1 NO - 1 NC extra late break <sup>2</sup>	

<sup>1</sup> EMERGENCY-STOP control devices according to IEC 60947-5-5 when provided with red operating head and positively driven NC contact blocks. Positive opening contacts according to IEC 60947-5-1, Appendix K.

<sup>2</sup> Blocks cannot be interchanged (stop-start circuit - pull to start, push to stop).

<sup>3</sup> For operator without contact blocks leave position f blank.

# Push Buttons & Signaling Devices

## 30mm Water, Oil Tight & Corrosion Resistant – Class 52

### Non-Illuminated Push Pull

#### Selection Tables

### 2 & 3 Position Push-Pull Mushroom Head Devices - Non-Illuminated

		2 pos - maintained					
		Metal Ø 1 3/4"		Plastic Ø 1 3/4"		Plastic Ø 2 1/2"	
Contacts	Color	Chrome	Black Max	Chrome	Black Max	Chrome	Black Max
—	Black	—	—	<b>52PP2W1</b>	52BP2W1	52PP2V1	2BP2V1
	Red	<b>52PP2A2</b>	52BP2A2	<b>52PP2W2</b>	<b>52BP2W2</b>	<b>52PP2V2</b>	52BP2V2
	Green	52PP2A3	52BP2A3	<b>52PP2W3</b>	52BP2W3	52PP2V3	52BP2V3
	Yellow	—	—	52PP2W4	52BP2W4	52PP2V4	52BP2V4
1 NO - 1 NC	Red	<b>52PP2A2A<sup>1</sup></b>	<b>52BP2A2A<sup>1</sup></b>	<b>52PP2W2A<sup>1</sup></b>	<b>52BP2W2A<sup>1</sup></b>	<b>52PP2V2A<sup>1</sup></b>	52BP2V2A <sup>1</sup>
	Green	<b>52PP2A3A</b>	52BP2A3A	<b>52PP2W3A</b>	52BP2W3A	<b>52PP2V3A</b>	—
	Yellow	—	—	<b>52PP2W4A</b>	52BP2W4A	52BP2V4A	52BP2V4A
	Chrome	<b>52PP2ACA</b>	52BP2ACA	—	—	—	—

		3 pos - momentary in - momentary out					
		Metal Ø 1 3/4"		Plastic Ø 1 3/4"		Plastic Ø 2 1/2"	
Contacts	Color	Chrome	Black Max	Chrome	Black Max	Chrome	Black Max
—	Black	—	—	52PP3W1	52BP3W1	52PP3V1	52BP3V1
	Red	52PP3A2	52BP3A2	<b>52PP3W2</b>	52BP3W2	52PP3V2	52BP3V2
	Green	52PP3A3	52BP3A3	52PP3W3	52BP3W3	52PP3V3	2BP3V3
	Chrome	52PP3AC	52BP3AC	—	—	—	—
1 NO - 1 NCELB	Red	52PP3A2U	52BP3A2U	52PP3W2U	52BP3W2U	52PP3V2U	52BP3V2U
	Green	52PP3A3U	52BP3A3U	52PP3W3U	52BP3W3U	52PP3V3U	52BP3V3U

		3 pos - maintained in - momentary out					
		Metal Ø 1 3/4"		Plastic Ø 1 3/4"		Plastic Ø 2 1/2"	
Contacts	Color	Chrome	Black Max	Chrome	Black Max	Chrome	Black Max
—	Black	—	—	52PP7W1	52BP7W1	52PP7V1	52BP7V1
	Red	<b>52PP7A2</b>	52BP7A2	52PP7W2	52BP7W2	52PP7V2	52BP7V2
	Green	52PP7A3	52BP7A3	52PP7W3	52BP7W3	52PP7V3	52BP7V3
	Chrome	52PP7AC	52BP7AC	—	—	—	—
1 NO - 1 NCELB	Red	52PP7A2U1	52BP7A2U	52PP7W2U	52BP7W2U	52PP7V2U	52BP7V2U
	Green	52PP7A3U	52BP7A3U	52PP7W3U	52BP7W3U	52PP7V3U	52BP7V3U

Readily available items are in **bold**.  
This is a small representation of stocked items.

<sup>1</sup> EMERGENCY-STOP control devices according to IEC 60947-5-5

• Revised •  
11/15/14

# Push Buttons & Signaling Devices

## 30mm Water, Oil Tight & Corrosion Resistant – Class 52

### Illuminated Push Pull & Push Button

1  
2  
3  
4  
5  
6  
7  
8  
9  
10

#### Selection Guide

### 2 & 3 Position Push-Pull Mushroom Head Devices - Illuminated



Mushroom Head Metal Ø 1 3/4"



Mushroom Head Plastic Ø 2 1/2"



Mushroom Head Plastic Ø 1 3/4"

Part Number	52	<u>    </u> a	<u>    </u> P b	<u>    </u> c	<u>    </u> d	<u>    </u> e	<u>    </u> f	<u>    </u> g
-------------	----	------------------	-----------------------	------------------	------------------	------------------	------------------	------------------

a	Code	Finish
	P	Chrome-Command 52
	B	Epoxy Coated-Black Max

b	Code	Type
	P	Push Pull Operator

c	Code	Function
	2	2 positions - maintained <sup>1</sup>
	3	3 positions - momentary in - momentary out <sup>2</sup>
	7	3 positions - maintained in - momentary out <sup>2</sup>

d	Code	Operation	
		Full Voltage <sup>3</sup> (AC/DC)	
		Incandescent	LED <sup>4</sup>
	B	6-8V	6V
	C	12-13V	—
	D	24-28V	24-28V
	E	120V	120V
	F	—	240V
		Transformer <sup>3</sup>	
	G	120V AC	
	H	240V AC	
	J	480V AC	
	K	600V AC	

e	Code	Style / Color
		Mushroom Head Metal Ø 1 3/4" (44.5mm)
	2	Red <sup>1</sup>
	3	Green
	5	Blue
	9	Amber
	A	Clear
	B	White
		Mushroom Head Plastic Ø 1 3/4" (44.5 mm)
	R	Red <sup>1</sup>
	S	Green
	T	Amber
		Mushroom Head Plastic Ø 2 1/2" (63.5mm)
	D	Red <sup>1</sup>
	E	Green
	F	Amber
		No Head (full voltage & transformer only)
	Z	No head

f	Code	Contact Blocks
		2 Position
	A	1 NO + 1 NC <sup>1</sup>
	B	2 NO - 2 NC <sup>1</sup>
	F	2 NO
	G	2 NC <sup>1</sup>
	J	1 NC <sup>1</sup>
	K	1 NO
	Q	1 NO - 1 NC (ELB)
		3 Position
	U	1 NO - 1 NC extra late break <sup>2</sup>

g	Code	Bulb Type
	Blank	Incandescent
	B	LED
	Y	Super-Bright LED <sup>5</sup>

<sup>1</sup> EMERGENCY-STOP control devices according to IEC 60947-5-5 when provided with red operating head and positively driven NC contact blocks.

Positive opening contacts according to IEC 60947-5-1, Appendix K,

<sup>2</sup> Blocks cannot be interchanged (stop-start circuit - pull to start, push to stop).

<sup>3</sup> Default bulb type is incandescent. For LED options, append field g. LED option not available on units sold "no head".

<sup>4</sup> LED voltages apply to table g option code B and Y.

6V and 120V are currently AC only. Replaced by AC/DC rated versions end of 2014.

<sup>5</sup> Not available in 240V.

# Push Buttons & Signaling Devices

## 30mm Water, Oil Tight & Corrosion Resistant – Class 52

### Illuminated Push Pull

#### Selection Tables

Type	Lamp Type	Voltage	Color	Contacts
Full Voltage (AC/DC)	LED	24V	Red	1 NO - 1 NC
			Green	1 NO - 1 NC
	Incandescent	24V	Red	1 NO - 1 NC
			Green	1 NO - 1 NC
		120V	Red	1 NO - 1 NC
			—	—
Transformer (AC)	LED	120V	Red	1 NO - 1 NC
			Green	1 NO - 1 NC
	Incandescent	120V	Red	1 NO - 1 NC
			Green	1 NO - 1 NC

Operator Type			
2 pos - maintained			
Metal Ø 1 3/4"		Plastic Ø 1 3/4"	
Chrome	Black Max	Chrome	Black Max
<b>52PP2D2AB<sup>1</sup></b>	<b>52BP2D2AB<sup>1</sup></b>	<b>52PP2DRAB<sup>1</sup></b>	<b>52BP2DRAB<sup>1</sup></b>
<b>52PP2D3AB</b>	<b>52BP2D3AB</b>	<b>52PP2DSAB</b>	<b>52BP2DSAB</b>
<b>52PP2D2A<sup>1</sup></b>	<b>52BP2D2A<sup>1</sup></b>	<b>52PP2DRA<sup>1</sup></b>	<b>52BP2DRA<sup>1</sup></b>
<b>52PP2D3A</b>	<b>52BP2D3A</b>	<b>52PP2DSA</b>	<b>52BP2DSA</b>
52PP2E2A <sup>1</sup>	52BP2E2A <sup>1</sup>	52PP2ERA <sup>1</sup>	52BP2ERA <sup>1</sup>
52PP2E2	52BP2E2	52PP2ER	52BP2ER
<b>52PP2G2AB<sup>1</sup></b>	<b>52BP2G2AB<sup>1</sup></b>	<b>52PP2GRAB<sup>1</sup></b>	<b>52BP2GRAB<sup>1</sup></b>
<b>52PP2G3AB</b>	<b>52BP2G3AB</b>	<b>52PP2GSAB</b>	<b>52BP2GSAB</b>
<b>52PP2G2A<sup>1</sup></b>	<b>52BP2G2A<sup>1</sup></b>	<b>52PP2GRA<sup>1</sup></b>	<b>52BP2GRA<sup>1</sup></b>
<b>52PP2G3A</b>	<b>52BP2G3A</b>	<b>52PP2GSA</b>	<b>52BP2GSA</b>

Type	Lamp Type	Voltage	Color	Contacts
Full Voltage (AC/DC)	LED	24V	Green	1 NO - 1 NCELB
			Green	1 NO - 1 NCELB
	Incandescent	24V	Red	1 NO - 1 NCELB
			Red	—
		120V	Red	—
			—	—
Transformer (AC)	LED	120V	Red	1 NO - 1 NCELB
			Green	1 NO - 1 NCELB
	Incandescent	120V	Red	1 NO - 1 NCELB
			Green	1 NO - 1 NCELB

Operator Type			
3 pos - momentary in - momentary out			
Metal Ø 1 3/4"		Plastic Ø 1 3/4"	
Chrome	Black Max	Chrome	Black Max
52PP3D3UB	52BP3D3UB	52PP3DRUB	52BP3DRUB
52PP3D3U	52BP3D3U	52PP3DSU	52BP3DSU
52PP3D2U	52BP3D2U	52PP3DRU	52BP3DRU
52PP3E2	52BP3E2	52PP3ER	52BP3ER
52PP3G2UB	52BP3G2UB	52PP3GRUB	52BP3GRUB
<b>52PP3G3UB</b>	<b>52BP3G3UB</b>	<b>52PP3GSUB</b>	<b>52BP3GSUB</b>
52PP3G2U	52BP3G2U	52PP3GRU	52BP3GRU
52PP3G3U	52BP3G3U	52PP3GRU	52BP3GRU

Type	Lamp Type	Voltage	Color	Contacts
Full Voltage (AC/DC)	LED	24V	Green	1 NO - 1 NCELB
			Green	1 NO - 1 NCELB
	Incandescent	24V	Red	1 NO - 1 NCELB
			Red	—
		120V	Red	—
			—	—
Transformer (AC)	LED	120V	Red	1 NO - 1 NCELB
			Green	1 NO - 1 NCELB
	Incandescent	120V	Red	1 NO - 1 NCELB
			Green	1 NO - 1 NCELB

Operator Type			
3 pos - maintained in - momentary out			
Metal Ø 1 3/4"		Plastic Ø 1 3/4"	
Chrome	Black Max	Chrome	Black Max
52PP7D3UB	52BP7D3UB	52PP7DSUB	52BP7DSUB
52PP7D3U	52BP7D3U	52PP7DSU	52BP7DSU
52PP7D2U	52BP7D2U	52PP7DRU	52BP7DRU
52PP7E2	52BP7E2	52PP7ER	52BP7ER
52PP7G2UB	52BP7G2UB	52PP7GRUB	52BP7GRUB
52PP7G3UB	52BP7G3UB	52PP7GSUB	52BP7GSUB
52PP7G2U	52BP7G2U	52PP7GRU	52BP7GRU
52PP7G3U	52BP7G3U	52PP7GRU	52BP7GRU

Readily available items are in **bold**.  
This is a small representation of stocked items.

<sup>1</sup> EMERGENCY-STOP control devices according to IEC 60947-5-5

# Push Buttons & Signaling Devices

## 30mm Water, Oil Tight & Corrosion Resistant – Class 52

Non-Illuminated Twist-to-Release

1

2

3

4

5

6

7

8

9

10

### Selection Guide

#### 2 Position Twist-to-Release Devices Mushroom Head - Non-Illuminated



Plastic 1 3/4" Mushroom Head - Chrome



Plastic 1 3/4" Mushroom Head - Black Max

<b>Part Number</b>	<b>52</b>	<u>    </u> <b>a</b>	<u>    </u> <b>R</b> <b>b</b>	<u>    </u> <b>8</b> <b>c</b>	<u>    </u> <b>W</b> <b>d</b>	<u>    </u> <b>e</b>	<u>    </u> <b>f<sup>2</sup></b>
--------------------	-----------	-------------------------	-------------------------------------	-------------------------------------	-------------------------------------	-------------------------	-------------------------------------

Finish	Function	Style	Color	Contacts	Part Number
Chrome	2 Position Twist-to-Release	Plastic 1 3/4" Mushroom Head	Red	1 NO - 1 NC	<b>52PR8W2A</b>
Black Max	2 Position Twist-to-Release	Plastic 1 3/4" Mushroom Head	Red	1 NO - 1 NC	<b>52BR8W2A</b>
Chrome	2 Position Twist-to-Release	Plastic 1 3/4" Mushroom Head	Red	None	52PR8W2

Readily available items are in **bold**.  
This is a small representation of stocked items.

<b>a</b>	<b>Code</b>	<b>Finish</b>
	<b>P</b>	Chrome-Command 52
	<b>B</b>	Epoxy Coated-Black Max
<b>b</b>	<b>Code</b>	<b>Function</b>
	<b>R</b>	2 Position Twist-to-Release, Maintained <sup>1</sup>
<b>c</b>	<b>Code</b>	<b>Style</b>
	<b>8</b>	Plastic 1 3/4" Mushroom Head
<b>d</b>	<b>Code</b>	<b>Lamp Type</b>
	<b>W</b>	Non-Illuminated

<b>e</b>	<b>Code</b>	<b>Color</b>
	<b>2</b>	Red <sup>1</sup>
	<b>3</b>	Green
	<b>4</b>	Yellow
	<b>Z</b>	No head
<b>f<sup>2</sup></b>	<b>Code</b>	<b>Contact Blocks</b>
	<b>A</b>	1 NO + 1 NC <sup>1</sup>
	<b>B</b>	2 NO + 2 NC <sup>1</sup>
	<b>C</b>	3 NO + 3 NC <sup>1</sup>
	<b>D</b>	4 NO + 4 NC <sup>1</sup>
	<b>E</b>	1 NC (LB)
	<b>F</b>	2 NO
	<b>G</b>	2NC <sup>1</sup>
	<b>H</b>	1NO (EM)
	<b>J</b>	1 NC <sup>1</sup>
	<b>K</b>	1 NO

<sup>1</sup> EMERGENCY-STOP control devices according to IEC 60947-5-5 when provided with red operating head and positively driven NC contact blocks. Positive opening contacts according to IEC 60947-5-1, Appendix K.

<sup>2</sup> For operator without contact blocks leave position f blank.

# Push Buttons & Signaling Devices

## 30mm Water, Oil Tight & Corrosion Resistant – Class 52

• Revised •  
11/15/14

### Illuminated Twist-to-Release

#### Selection Guide

### 2 Position Twist-to-Release Mushroom Head Devices - Illuminated



Plastic 1 3/4" Mushroom Head - Chrome



Plastic 1 3/4" Mushroom Head - Black Max

Part Number	<b>52</b>	<b>a</b>	<b>R</b>	<b>8</b>	<b>d</b>	<b>e</b>	<b>f</b>	<b>g</b>
-------------	-----------	----------	----------	----------	----------	----------	----------	----------

Finish	Style	Voltage	Bulb Type	Color	Contacts	Part Number
Chrome	Plastic 1 3/4" Mushroom Head	24V	LED	Red	1 NO - 1 NC	52PR8DRAB
Chrome	Plastic 1 3/4" Mushroom Head	120V	Incandescent	Red	1 NO - 1 NC	52PR8ERA
Chrome	Plastic 1 3/4" Mushroom Head	120V	LED	Red	1 NO - 1 NC	52PR8GRAB

Readily available items are in **bold**.  
This is a small representation of stocked items.

a	Code	Finish
	<b>P</b>	Chrome-Command 52
	<b>B</b>	Epoxy Coated-Black Max

b	Code	Function
	<b>R</b>	2 Position Twist-to-Release, Maintained

c	Code	Style
	<b>8</b>	Plastic 1 3/4" Mushroom Head

d	Code	Operation	
		<b>Full Voltage<sup>2</sup> (AC/DC)</b>	
		<b>Incandescent</b>	<b>LED<sup>3</sup></b>
	<b>B</b>	6-8V	6V
	<b>C</b>	12-13V	—
	<b>D</b>	24-28V	24-28V
	<b>E</b>	120V	120V
	<b>F</b>	—	240V
		<b>Transformer<sup>2</sup></b>	
	<b>G</b>	120V AC	
	<b>H</b>	240V AC	
	<b>J</b>	480V AC	
	<b>K</b>	600V AC	

e	Code	Color
	<b>R</b>	Red <sup>1</sup>
	<b>S</b>	Green
	<b>T</b>	Amber
	<b>Z</b>	No head

f	Code	Contact Blocks
	<b>A</b>	1 NO + 1 NC <sup>1</sup>
	<b>B</b>	2 NO + 2 NC <sup>1</sup>
	<b>C</b>	3 NO + 3 NC <sup>1</sup>
	<b>D</b>	4 NO + 4 NC <sup>1</sup>
	<b>E</b>	1 NC (LB)
	<b>F</b>	2 NO
	<b>G</b>	2NC <sup>1</sup>
	<b>H</b>	1NO (EM)
	<b>J</b>	1 NC <sup>1</sup>
<b>K</b>	1 NO	

g	Code	Bulb Type
	<b>Blank</b>	Incandescent
	<b>B</b>	LED
	<b>Y</b>	Super-Bright LED <sup>4</sup>

1 EMERGENCY-STOP control devices according to IEC 60947-5-5 when provided with red operating head and positively driven NC contact blocks. Positive opening contacts according to IEC 60947-5-1, Appendix K, Molded bodies.

2 Default bulb type is incandescent. For LED options, append field g. LED option not available on units sold "no head."

3 LED voltages apply to table g option code B and Y. 6V and 120V are currently AC only. Replaced by AC/DC rated versions end of 2014.

4 Not available in 240V.



• Revised •  
11/15/14

# Push Buttons & Signaling Devices

## 30mm Water, Oil Tight & Corrosion Resistant – Class 52

Indicator Light

1  
2  
3  
4  
5  
6  
7  
8  
9  
10

### Selection Guide

#### Indicator Light



Plastic Lens



Glass Lens

<b>Part Number</b>	<b>52</b>	<u>    </u> <b>a</b>	<u>    </u> <b>L</b> <b>b</b>	<u>    </u> <b>c</b>	<u>    </u> <b>d</b>	<u>    </u> <b>e</b>	<u>    </u> <b>f</b>
--------------------	-----------	-------------------------	-------------------------------------	-------------------------	-------------------------	-------------------------	-------------------------

<b>a</b>	<b>Code</b>	<b>Finish</b>
	P	Chrome-Command 52
	B	Epoxy Coated-Black Max

<b>b</b>	<b>Code</b>	<b>Type</b>
	L	Indicator Light

<b>c</b>	<b>Code</b>	<b>Style</b>
	4	Plastic Lens
	5	Glass Lens

<b>d</b>	<b>Code</b>	<b>Operation</b>	
		<b>Full Voltage<sup>1</sup> (AC/DC)</b>	
		<b>Incandescent</b>	<b>LED<sup>2</sup></b>
	B	6-8V	6V
	C	12-13V	—
	D	24-28V	24-28V
	E	120V	120V
	F	—	240V
		<b>Transformer<sup>1</sup></b>	
	G	120V AC	
	H	240V AC	
	J	480V AC	
	K	600V AC	

<b>e</b>	<b>Code</b>	<b>Color</b>
	2	Red
	3	Green
	5	Blue
	7	All Colors
	9	Amber
	A	Clear
	B	White
N	No Lens	

<b>f</b>	<b>Code</b>	<b>Bulb Type</b>
	Blank	Incandescent
	XB	LED
	XY	Super-Bright LED <sup>3</sup>

<sup>1</sup> Default bulb type is incandescent. For LED options, append field f. LED option not available on units sold "No Lens".

<sup>2</sup> LED voltages apply to table f option code XB and XY. 6V, 24V (Super Bright only) and 120V are currently AC only. Replaced by AC/DC rated versions end of 2014.

<sup>3</sup> Not available in 240V.

# Push Buttons & Signaling Devices

## 30mm Water, Oil Tight & Corrosion Resistant – Class 52

### Indicator Lights

#### Selection Tables

#### Indicator Light

Type	Lamp Type	Voltage	Color	Plastic Lens	
				Chrome	Black Max
Full Voltage (AC/DC)	LED	24V	Red	<b>52PL4D2XB</b>	<b>52BL4D2XB</b>
			Green	<b>52PL4D3XB</b>	<b>52BL4D3XB</b>
			Blue	<b>52PL4D5XB</b>	<b>52BL4D5XB</b>
			Amber	<b>52PL4D9XB</b>	<b>52BL4D9XB</b>
			White	<b>52PL4DBXB</b>	<b>52BL4DBXB</b>
		120V	Red	<b>52PL4E2XB</b>	<b>52BL4E2XB</b>
			Green	<b>52PL4E3XB</b>	<b>52BL4E3XB</b>
			Amber	<b>52PL4E9XB</b>	<b>52BL4E9XB</b>
			Clear	<b>52PL4EAXB</b>	<b>52BL4EAXB</b>
			White	<b>52PL4EBXB</b>	<b>52BL4EBXB</b>
	Incandescent	24V	Red	<b>52PL4D2</b>	<b>52BL4D2</b>
			Green	<b>52PL4D3</b>	<b>52BL4D3</b>
			Blue	<b>52PL4D5</b>	<b>52BL4D5</b>
			Amber	<b>52PL4D9</b>	<b>52BL4D9</b>
			White	<b>52PL4DB</b>	<b>52BL4DB</b>
		No Lens	<b>52PL4DN</b>	<b>52BL4DN</b>	
		120V	Red	<b>52PL4E2</b>	<b>52BL4E2</b>
			Green	<b>52PL4E3</b>	<b>52BL4E3</b>
Amber	<b>52PL4E9</b>		<b>52BL4E9</b>		
No Lens	<b>52PL4EN</b>	<b>52BL4EN</b>			
Transformer (AC)	LED	120V	Red	<b>52PL4G2XB</b>	<b>52BL4G2XB</b>
			Green	<b>52PL4G3XB</b>	<b>52BL4G3XB</b>
			Amber	<b>52PL4G9XB</b>	<b>52BL4G9XB</b>
			White	<b>52PL4GBXB</b>	<b>52BL4GBXB</b>
		480V	Red	<b>52PL4J2XB</b>	<b>52BL4J2XB</b>
			Green	<b>52PL4J3XB</b>	<b>52BL4J3XB</b>
			White	<b>52PL4JBXB</b>	<b>52BL4JBXB</b>
			No Lens	<b>52PL4JN</b>	<b>52BL4JN</b>
	Incandescent	120V	Red	<b>52PL4G2</b>	<b>52BL4G2</b>
			Green	<b>52PL4G3</b>	<b>52BL4G3</b>
			Amber	<b>52PL4G9</b>	<b>52BL4G9</b>
			White	<b>52PL4GB</b>	<b>52BL4GB</b>
			No Lens	<b>52PL4GN</b>	<b>52BL4GN</b>
		240V	Red	<b>52PL4H2</b>	<b>52BL4H2</b>
			Green	<b>52PL4H3</b>	<b>52BL4H3</b>
			No Lens	<b>52PL4HN</b>	<b>52BL4HN</b>
		480V	Red	<b>52PL4J2</b>	<b>52BL4J2</b>
			Green	<b>52PL4J3</b>	<b>52BL4J3</b>
Amber	<b>52PL4J9</b>	<b>52BL4J9</b>			

Readily available items are in **bold**.  
This is a small representation of stocked items.

• Revised •  
11/15/14

# Push Buttons & Signaling Devices

## 30mm Water, Oil Tight & Corrosion Resistant – Class 52

### Illuminated Push Button & Push-to-Test

1  
2  
3  
4  
5  
6  
7  
8  
9  
10

#### Selection Guide

#### Push Button & Push-to-Test - Illuminated



Extended Lens



Flush Lens

Part Number	52	<u>    </u>	<u>    </u>	<u>    </u>	<u>    </u>	<u>    </u>	<u>    </u>	<u>    </u>
		<b>a</b>	<b>T</b>	<b>c</b>	<b>d</b>	<b>e</b>	<b>f</b>	<b>g</b>

<b>a</b>	Code	Finish
	P	Chrome-Command 52
	B	Epoxy Coated-Black Max

<b>b</b>	Code	Function
	T	Illuminated Push Button / Push-to-Test <sup>1</sup>

<b>c</b>	Code	Style
	6	Extended Lens
	8	Flush Lens <sup>2</sup>

<b>d</b>	Code	Operation	
		Full Voltage <sup>3</sup> (AC/DC)	
		Incandescent	LED <sup>4</sup>
	B	6-8V	6V
	C	12-13V	—
	D	24-28V	24-28V
	E	120V	120V
	F	—	240V
		Transformer <sup>3</sup>	
	G	120V AC	
H	240V AC		
J	480V AC		
K	600V AC		

<b>e</b>	Code	Color
	2	Red
	3	Green
	5	Blue
	7	All Colors
	9	Amber
	A	Clear
	B	White
N	No Lens	

<b>f</b>	Code	Contact Blocks
	A	1 NO - 1 NC
	B	2 NO + 2 NC
	C	3 NO + 3 NC
	D	4 NO + 4 NC
	E	1 NC (LB)
	F	2 NO
	G	2 NC
	H	1NO (EM)
	J	1 NC
	K	1 NO

<b>g</b>	Code	Bulb Type
	Blank	Incandescent
	B	LED
	Y	Super-Bright LED <sup>5</sup>

1 For push-to-test functionality, wire according to wiring diagram below.  
2 Products available fall 2014.

3 Default bulb type is incandescent. For LED options, append field g.  
LED option not available on units sold "No Lens".

4 LED voltages apply to table g option code B and Y.  
6V and 120V are currently AC only. Replaced by AC/DC rated versions end of 2014.

5 Not available in 240V.

#### Wiring Diagrams

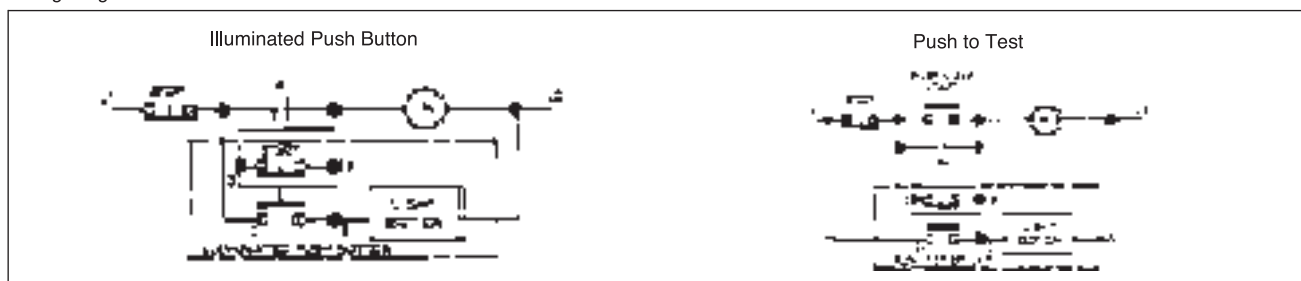

# Push Buttons & Signaling Devices

## 30mm Water, Oil Tight & Corrosion Resistant – Class 52

### Illuminated Push Buttons & Push-to-Test

#### Selection Tables

#### Push Button & Push-to-Test - Illuminated

Type	Lamp Type	Voltage	Color	Contacts	Extended Lens		
					Chrome	Black Max	
Full Voltage (AC/DC)	LED	24V	Red	1 NO - 1 NC	<b>52PT6D2AB</b>	<b>52BT6D2AB</b>	
			Green	1 NO - 1 NC	<b>52PT6D3AB</b>	<b>52BT6D3AB</b>	
			Blue	1 NO - 1 NC	<b>52PT6D5AB</b>	<b>52BT6D5AB</b>	
			Amber	1 NO - 1 NC	<b>52PT6D9AB</b>	<b>52BT6D9AB</b>	
			White	1 NO - 1 NC	<b>52PT6DBAB</b>	<b>52BT6DBAB</b>	
	Incandescent	24V	Red	1 NO - 1 NC	<b>52PT6E2AB</b>	<b>52BT6E2AB</b>	
			Green	1 NO - 1 NC	<b>52PT6E3AB</b>	<b>52BT6E3AB</b>	
			Red	1 NO - 1 NC	<b>52PT6D2A</b>	<b>52BT6D2A</b>	
			Green	1 NO - 1 NC	<b>52PT6D3A</b>	<b>52BT6D3A</b>	
			Blue	1 NO - 1 NC	<b>52PT6D5A</b>	<b>52BT6D5A</b>	
	Transformer (AC)	LED	120V	Amber	1 NO - 1 NC	<b>52PT6D9A</b>	<b>52BT6D9A</b>
				White	1 NO - 1 NC	<b>52PT6DBA</b>	<b>52BT6DBA</b>
				Red	1 NO - 1 NC	<b>52PT6E2A</b>	<b>52BT6E2A</b>
				Green	1 NO - 1 NC	<b>52PT6E3A</b>	<b>52BT6E3A</b>
Transformer (AC)	LED	240V	Red	1 NO - 1 NC	<b>52PT6G2AB</b>	<b>52BT6G2AB</b>	
			Green	1 NO - 1 NC	<b>52PT6G3AB</b>	<b>52BT6G3AB</b>	
			Amber	1 NO - 1 NC	<b>52PT6G9AB</b>	<b>52BT6G9AB</b>	
			White	1 NO - 1 NC	<b>52PT6GBAB</b>	<b>52BT6GBAB</b>	
			Red	1 NO - 1 NC	<b>52PT6H2AB</b>	<b>52BT6H2AB</b>	
	Incandescent	120V	Green	1 NO - 1 NC	<b>52PT6H3AB</b>	<b>52BT6H3AB</b>	
			Red	1 NO - 1 NC	<b>52PT6G2A</b>	<b>52BT6G2A</b>	
			Green	1 NO - 1 NC	<b>52PT6G3A</b>	<b>52BT6G3A</b>	
			Amber	1 NO - 1 NC	<b>52PT6G9A</b>	<b>52BT6G9A</b>	
			White	1 NO - 1 NC	<b>52PT6GBA</b>	<b>52BT6GBA</b>	
Incandescent	240V	No Lens	1 NO - 1 NC	<b>52PT6GNA</b>	<b>52BT6GNA</b>		
		Green	1 NO - 1 NC	<b>52PT6H3A</b>	<b>52BT6H3A</b>		
		Clear	1 NO - 1 NC	<b>52PT6JAA</b>	<b>52BT6JAA</b>		

Readily available items are in **bold**.  
This is a small representation of stocked items.

• Revised •  
11/15/14

# Push Buttons & Signaling Devices

## 30mm Water, Oil Tight & Corrosion Resistant – Class 52

### Illuminated Push Button

1  
2  
3  
4  
5  
6  
7  
8  
9  
10

#### Selection Guide

### Push Button Mushroom Head Devices – Illuminated<sup>4</sup>



Mushroom Head Metal Ø 1 3/4"



Mushroom Head Plastic Ø 2 1/2"



Mushroom Head Plastic Ø 1 3/4"

Part Number	<b>52</b>	<b>a</b>	<b>T</b>	<b>9</b>	<b>d</b>	<b>e</b>	<b>f</b>	<b>g</b>
-------------	-----------	----------	----------	----------	----------	----------	----------	----------

a	Code	Finish
	P	Chrome-Command 52
B	Epoxy Coated-Black Max	

b	Code	Type
	T	Push Button Operator

c	Code	Function
	9	2 positions – momentary in

d	Code	Operation	
	<b>Full Voltage<sup>2</sup> (AC/DC)</b>		
		Incandescent	LED <sup>3</sup>
B	6-8V	6V	6V
C	12-13V	—	—
D	24-28V	24-28V	24-28V
E	120V	120V	120V
F	—	240V	240V
<b>Transformer<sup>2</sup></b>			
G	120V AC		
H	240V AC		
J	480V AC		
K	600V AC		

e	Code	Style / Color
	<b>Mushroom Head Metal Ø 1 3/4" (44.5mm)</b>	
2		Red <sup>1</sup>
3		Green
5		Blue
9		Amber
A		Clear
B		White
<b>Mushroom Head Plastic Ø 1 3/4" (44.5 mm)</b>		
R		Red
S		Green
T		Amber
<b>Mushroom Head Plastic Ø 2 1/2" (63.5mm)</b>		
D		Red <sup>1</sup>
E		Green
F		Amber
<b>No Head (full voltage &amp; transformer only)</b>		
Z		No head

f	Code	Contact Blocks
	A	1 NO + 1 NC
B	2 NO + 2 NC	
C	3 NO + 3 NC	
D	4 NO + 4 NC	
E	1 NC (LB)	
F	2 NO	
G	2 NC	
H	1NO (EM)	
J	1 NC	
K	1 NO	

g	Code	Bulb Type
	Blank	Incandescent
B	LED	
Y	Super-Bright LED <sup>5</sup>	

1 Positive opening according to IEC 60947-5-1, Appendix K.  
 2 Default bulb type is incandescent. For LED options, append field g. LED option not available on units sold "no head".  
 3 LED voltages apply to table g option code B and Y. 6V and 120V are currently AC only. Replaced by AC/DC rated versions end of 2014.  
 4 Products available fall 2014.  
 5 Not available in 240V.

# Push Buttons & Signaling Devices

## 30mm Water, Oil Tight & Corrosion Resistant – Class 52

• Revised •  
07/15/16

### Illuminated Selector Switches

#### Selection Guide

#### Selector Switches – Illuminated



Short Lever – Chrome



Short Lever – Black Max

Part Number	<b>52</b>	<b>S</b>	<b>7</b>							
		<b>a</b>	<b>b</b>	<b>c</b>	<b>d</b>	<b>e</b>	<b>f</b>	<b>g</b>	<b>h</b>	<b>i</b>

Finish	Style	Cam Type	Function	Color	Contacts	Part Number
Chrome	Maintained	2 Position: CAM A	24-28V AC/DC	No Insert	None	52SA7ADN
Chrome	Maintained	2 Position: CAM A	120V AC (Transformer)	No Insert	None	<b>52SA7AGN</b>
Chrome	Maintained	3 Position: CAM C	120V AC	No Insert	None	<b>52SA7CGN</b>

Readily available items are in **bold**.  
This is a small representation of stocked items.

a	Code	Type
	<b>S</b>	Selector Switch

b	Code	Finish
	<b>A</b>	Chrome - Command 52
	<b>X</b>	Epoxy Coated - Black Max

c	Code	Style
	<b>7</b>	Maintained

d	Code	Function
	<b>A</b>	2 Position: CAM A
	<b>B</b>	3 Position: CAM B
	<b>C</b>	3 Position: CAM C

e	Code	Operation	
		Full Voltage <sup>1</sup> (AC/DC)	
		Incandescent	LED <sup>2</sup>
	<b>B</b>	6-8V	6V
	<b>C</b>	12-13V	—
	<b>D</b>	24-28V	24-28V
	<b>E</b>	120V	120V
	<b>F</b>	—	240V
		Transformer <sup>1</sup>	
	<b>G</b>	120V AC	
	<b>H</b>	240V AC	
	<b>J</b>	480V AC	
	<b>K</b>	600V AC	

f	Code	Color
	<b>2</b>	Red
	<b>3</b>	Green
	<b>5</b>	Blue
	<b>9</b>	Amber
	<b>A</b>	Clear
	<b>N</b>	No Insert

g	Code	Contact Blocks
	<b>A</b>	1 NO - 1 NC
	<b>E</b>	1 NC (LB)
	<b>H</b>	1 NO (EM)
	<b>J</b>	1 NC
	<b>K</b>	1 NO

h	Code	Contact Quantity & Location	
		A CAM & C CAM Left	B CAM Right
	<b>0</b>	1	—
	<b>1</b>	—	1
	<b>3</b>	2	—
	<b>4</b>	—	2

i	Code	Bulb Type
	<b>Blank</b>	Incandescent
	<b>B</b>	LED
	<b>Y</b>	Super-Bright LED <sup>3</sup>

<sup>1</sup> Default bulb type is incandescent. For LED options, append field i.  
LED option not available on units sold "no head".

<sup>2</sup> LED voltages apply to table i option code B and Y.  
6V and 120V are currently AC only. Replaced by AC/DC rated versions end of 2014.

<sup>3</sup> Not available in 240V.

For CAM selection see page 10/205.

• Revised •  
08/15/14

# Push Buttons & Signaling Devices

## 30mm Water, Oil Tight & Corrosion Resistant – Class 52

### Non-Illuminated Selector Switch

1  
2  
3  
4  
5  
6  
7  
8  
9  
10

#### Selection Guide

### Selector Switch – Non-Illuminated



Short Lever



Long Lever

<b>Part Number</b>	<b>52</b>	<b>S</b>	<b>2</b>						
		<b>a</b>	<b>b</b>	<b>c</b>	<b>d</b>	<b>e</b>	<b>f</b>	<b>g<sup>2</sup></b>	<b>h<sup>2</sup></b>

<b>a</b>	<b>Code</b>	<b>Type</b>
	S	Selector Switch

<b>b</b>	<b>Code</b>	<b>Finish</b>
	A	Chrome - Short Lever
	B	Chrome - Long Lever
	X	BlackMax - Short Lever
	W	BlackMax - Long Lever

<b>c</b>	<b>Code</b>	<b>Style</b>
	2	Non-Illuminated

<b>d</b>	<b>Code</b>	<b>Function</b>
	A	2 Position: CAM A
	B	3 Position: CAM B
	C	3 Position: CAM C <sup>1</sup>
	D	3 Position: CAM D
	E	3 Position: CAM E
	G	3 Position: CAM G
	H	4 Position: CAM H

<b>e</b>	<b>Code</b>	<b>Type</b>	
		<b>2 Position</b>	
		<b>Maintained</b>	<b>Spring Return</b>
	A	All	—
	C	Left	Right
		<b>3 Position</b>	
		<b>Maintained</b>	<b>Spring Return</b>
	A	All	—
	B	Center, Right	Left
	C	Center, Left	Right
	D	Center	Left, Right
		<b>4 Position</b>	
		<b>Maintained Position</b>	<b>Spring Return</b>
	A	All	—

<b>f</b>	<b>Code</b>	<b>Color</b>
	2	Red
	3	Green
	4	Yellow
	5	Blue
	6	Gray
	8	Orange
	B	White
	N	No Insert (Black)

<b>g<sup>2</sup></b>	<b>Code</b>	<b>Contact Blocks</b>
	A	1 NO - 1 NC
	E	1 NC (LB)
	H	1 NO (EM)
	J	1 NC
	K	1 NO

<b>h<sup>2</sup></b>	<b>Code</b>		<b>Contact Quantity &amp; Location</b>	
			<b>Left</b>	<b>Right</b>
	0		1	—
	1		—	1
	2		1	1
	3		2	—
	4		—	2
	5		2	1
	6		1	2
	7		2	2
	8		3	—
	9		—	3

<sup>1</sup> C CAM on spring return selectors is limited to 4 contact blocks.  
For CAM selection see page 10/205.

<sup>2</sup> For operator without contact blocks leave positions g and h blank.

# Push Buttons & Signaling Devices

## 30mm Water, Oil Tight & Corrosion Resistant – Class 52

### Non-Illuminated Selector Switch

#### Selector Switch, Non-Illuminated<sup>1)</sup>

Contact Type	Contact	Switch Position		Type M = Maintained S = Spring Return	Chrome		Black Max	
		Left	Right		Short Lever	Long Lever	Short Lever	Long Lever
					<b>2-Position Operator</b>			
No Contacts	—	—	—	M M	<b>52SA2AAB</b>	<b>52SB2AAB</b>	<b>52SX2AAB</b>	<b>52SW2AAB</b>
				M<---S	<b>52SA2ACB</b>	<b>52SB2ACB</b>	<b>52SX2ACB</b>	<b>52SW2ACB</b>
1 N.O.	A	O	X	M M	<b>52SA2AABK1</b>	<b>52SB2AABK1</b>	<b>52SX2AABK1</b>	<b>52SW2AABK1</b>
				M<---S	<b>52SA2ACBK1</b>	<b>52SB2ACBK1</b>	<b>52SX2ACBK1</b>	<b>52SW2ACBK1</b>
1 N.O.	A	O	X	M M	<b>52SA2AABA1</b>	<b>52SB2AABA1</b>	<b>52SX2AABA1</b>	<b>52SW2AABA1</b>
1 N.C.	B	X	O	M<---S	<b>52SA2ACBA1</b>	<b>52SB2ACBA1</b>	<b>52SX2ACBA1</b>	<b>52SW2ACBA1</b>

Contact Type	Contact	Switch Position			Type M = Maintained S = Spring Return	Chrome		Black Max	
		Left	Center	Right		Short Lever	Long Lever	Short Lever	Long Lever
						<b>3-Position Operator</b>			
No Contacts	—	—	—	—	M M M	<b>52SA2CAB</b>	<b>52SB2CAB</b>	<b>52SX2CAB</b>	<b>52SW2CAB</b>
					M M M	<b>52SA2BAB</b>	<b>52SB2BAB</b>	<b>52SX2BAB</b>	<b>52SW2BAB</b>
					S--->M M	<b>52SA2BBB</b>	<b>52SB2BBB</b>	<b>52SX2BBB</b>	<b>52SW2BBB</b>
					M M<----S	<b>52SA2BCB</b>	<b>52SB2BCB</b>	<b>52SX2BCB</b>	<b>52SW2BCB</b>
					S--->M<---S	<b>52SA2BDB</b>	<b>52SB2BDB</b>	<b>52SX2BDB</b>	<b>52SW2BDB</b>
1 N.O.	A	O	O	X	M M M	<b>52SA2CABA1</b>	<b>52SB2CABA1</b>	<b>52SX2CABA1</b>	<b>52SW2CABA1</b>
					S--->M M	<b>52SA2CBBA1</b>	<b>52SB2CBBA1</b>	<b>52SX2CBBA1</b>	<b>52SW2CBBA1</b>
1 N.C.	B	X	O	O	M M<----S	<b>52SA2CCBA1</b>	<b>52SB2CCBA1</b>	<b>52SX2CCBA1</b>	<b>52SW2CCBA1</b>
					S--->M<---S	<b>52SA2CDBA1</b>	<b>52SB2CDBA1</b>	<b>52SX2CDBA1</b>	<b>52SW2CDBA1</b>
1 N.O.	A	O	O	X	M M M	<b>52SA2CABA2</b>	<b>52SB2CABA2</b>	<b>52SX2CABA2</b>	<b>52SW2CABA2</b>
1 N.C.	B	X	O	O	S--->M M	<b>52SA2CBBA2</b>	<b>52SB2CBBA2</b>	<b>52SX2CBBA2</b>	<b>52SW2CBBA2</b>
1 N.O.	C	O	O	X	M M<----S	<b>52SA2CCBA2</b>	<b>52SB2CCBA2</b>	<b>52SX2CCBA2</b>	<b>52SW2CCBA2</b>
1 N.C.	D	X	O	O	S--->M<---S	<b>52SA2CDBA2</b>	<b>52SB2CDBA2</b>	<b>52SX2CDBA2</b>	<b>52SW2CDBA2</b>
1 N.O.	A	O	O	X	M M M	<b>52SA2GABJ2K1</b>	<b>52SB2GABJ2K1</b>	<b>52SX2GABJ2K1</b>	<b>52SW2GABJ2K1</b>
1 N.C.	B	X	O	O	M M M	<b>52SA2GABJ2K1</b>	<b>52SB2GABJ2K1</b>	<b>52SX2GABJ2K1</b>	<b>52SW2GABJ2K1</b>
1 N.C.	C	O	X	O	M M M	<b>52SA2GABJ2K1</b>	<b>52SB2GABJ2K1</b>	<b>52SX2GABJ2K1</b>	<b>52SW2GABJ2K1</b>

Contact Type	Contact	Switch Position				Type M = Maintained S = Spring Return	Chrome		Black Max	
		Left	Center	Center	Right		Short Lever	Long Lever	Short Lever	Long Lever
							<b>4-Position Operator</b>			
No Contacts	—	—	—	—	—	M M M M	<b>52SA2HAB</b>	<b>52SB2HAB</b>	<b>52SX2HAB</b>	<b>52SW2HAB</b>
1 N.O.	A	X	O	O	O	M M M M	<b>52SA2HABJ2K1</b>	<b>52SB2HABJ2K1</b>	<b>52SX2HABJ2K1</b>	<b>52SW2HABJ2K1</b>
1 N.C.	B	O	X	O	O	M M M M	<b>52SA2HABJ2K1</b>	<b>52SB2HABJ2K1</b>	<b>52SX2HABJ2K1</b>	<b>52SW2HABJ2K1</b>
1 N.C.	C	O	O	X	O	M M M M	<b>52SA2HABJ2K1</b>	<b>52SB2HABJ2K1</b>	<b>52SX2HABJ2K1</b>	<b>52SW2HABJ2K1</b>
1 N.O.	A	O	O	O	X	M M M M	<b>52SA2HABJ2K2</b>	<b>52SB2HABJ2K2</b>	<b>52SX2HABJ2K2</b>	<b>52SW2HABJ2K2</b>
1 N.O.	B	X	O	O	O	M M M M	<b>52SA2HABJ2K2</b>	<b>52SB2HABJ2K2</b>	<b>52SX2HABJ2K2</b>	<b>52SW2HABJ2K2</b>
1 N.C.	C	O	X	O	O	M M M M	<b>52SA2HABJ2K2</b>	<b>52SB2HABJ2K2</b>	<b>52SX2HABJ2K2</b>	<b>52SW2HABJ2K2</b>
1 N.C.	D	O	O	X	O	M M M M	<b>52SA2HABJ2K2</b>	<b>52SB2HABJ2K2</b>	<b>52SX2HABJ2K2</b>	<b>52SW2HABJ2K2</b>

Note: X = Closed / O = Open

1) Readily available items are in **bold**.

This is a small representation of stocked items.



• Revised •  
07/15/16

# Push Buttons & Signaling Devices

## 30mm Water, Oil Tight & Corrosion Resistant – Class 52

### Keyed Selector Switch

1  
2  
3  
4  
5  
6  
7  
8  
9  
10

#### Selection Guide

### Keyed Selector Switch

Part Number	<b>52</b>	<b>S</b>	<b>C</b>						
		<b>a</b>	<b>b</b>	<b>c</b>	<b>d</b>	<b>e</b>	<b>f<sup>3</sup></b>	<b>g<sup>3</sup></b>	<b>h</b>

<b>a</b>	<b>Code</b>	<b>Type</b>
	S	Selector Switch

<b>b</b>	<b>Code</b>	<b>Finish</b>
	C	Chrome – Command 52

<b>c</b>	<b>Code</b>	<b>Style</b>
	5	Non-Standard Lock/Key <sup>1a</sup>
	6	Standard Lock/Key

<b>d</b>	<b>Code</b>	<b>Function</b>
	A	2 Position: CAM A
	B	3 Position: CAM B
	C	3 Position: CAM C <sup>2</sup>
	D	3 Position: CAM D
	E	3 Position: CAM E
	G	3 Position: CAM G
	H	4 Position: CAM H

<b>e</b>	<b>Code</b>	<b>Lock Type</b>		
		2 Position		
		Maintained / Spring Return	Key Removal	
			Left	Right
	E	All Maintained	X	X
	F	All Maintained	X	—
	G	All Maintained	—	X
	X	Spring from Right	X	—

	3 Position					
		Maintained Position	Spring Return	Key Removal		
				Left	Center	Right
	E	All	—	X	X	X
	F	All	—	X	—	—
	G	All	—	—	—	X
	H	All	—	—	X	—
	J	All	—	X	—	X
	K	All	—	X	X	—
	M	All	—	—	X	X
	T	Center, Right	Left	—	X	—
	U	Left, Center	Right	—	X	—
	V	Center	Left, Right	—	X	—
	W	Center, Right	Left	—	—	X
Y	Center, Right	Left	—	X	X	
Z	Left, Center	Right	X	X	X	

	4 Position					
		Maintained Position	Key Removal			
			Left	Left Center	Right Center	Right
	E	All	X	X	X	X
	F	All	X	—	—	—
G	All	—	—	—	X	

<b>f<sup>3</sup></b>	<b>Code</b>	<b>Contact Blocks</b>
	A	1 NO - 1 NC
	J	1 NC
	K	1 NO
	E	1 NC (LB)
H	1 NO (EM)	

<b>g<sup>3</sup></b>	<b>Code</b>	<b>Contact Quantity &amp; Location</b>	
		Left	Right
	0	1	—
	1	—	1
	2	1	1
	3	2	—
	4	—	2
	5	2	1
	6	1	2
	7	2	2
8	3	—	
9	—	3	

<b>h</b>	<b>Code</b>	<b>Key Type<sup>1b</sup></b>
	Blank	501CH
	X298	550CH
	X299	549CH
	X300	548CH
	X301	547CH
X302	506CH	



Standard Lock/Key

1a. To Order 1 to 25 special locks for keyed selector switches simply replace the 6 in the 5th digit of the catalog number with a 5 when entering your order.

(Ordering Example: 52SC6AE is changed to 52SC5AE and all locks - up to 25 will be unique).

1b. b. To order the specific lock types shown in table **h**, simply append the corresponding "X" suffix to a standard part number (Ordering Example: 52SC6AEX298).

Note: Same list price applies as standard keyed locks.

2. C CAM on spring return selectors is limited to 4 contact blocks. For CAM selection see page 10/205.

3 For operator without contact blocks leave positions f and g blank.

# Push Buttons & Signaling Devices

## 30mm Water, Oil Tight & Corrosion Resistant – Class 52

### Keyed Selector Switch

#### Key-operated Selector Switch, Non-Illuminated<sup>1)</sup>

Contact Type	Contact	Switch Position		Type	Key Removal	
		Left	Right	M = Maintained S = Spring Return	Left	Both
					<b>2-Position Operator</b>	
No Contacts	—	—	—	M M	<b>52SC6AF</b>	<b>52SC6AE</b>
				M<---S	<b>52SC6AX</b>	—
1 N.O.	A	O	X	M M	<b>52SC6AFK1</b>	<b>52SC6AEK1</b>
				M<---S	<b>52SC6AXK1</b>	—
1 N.O.	A	O	X	M M	<b>52SC6AFA1</b>	<b>52SC6AEA1</b>
1 N.C.	B	X	O	M<---S	<b>52SC6AXA1</b>	—

Contact Type	Contact	Switch Position			Type	Key Removal							
		Left	Center	Right	M = Maintained S = Spring Return	Left	Right	Center	Left & Center	Left & Right	Center & Right	All Positions	
						<b>3-Position Operator</b>							
No Contacts	—	—	—	—	M M M	52SC6CF	52SC6CG	52SC6CH	52SC6CK	52SC6CJ	52SC6CM	<b>52SC6CE</b>	
					M M M	<b>52SC6BF</b>	<b>52SC6BG</b>	52SC6BH	52SC6BK	52SC6BJ	52SC6BM	<b>52SC6BE</b>	
					S---M	M	—	52SC6BW	52SC6BT	—	—	52SC6BY	—
					M M<----S	—	—	52SC6BU	52SC6BZ	—	—	—	—
					S---M<---S	—	—	52SC6BV	—	—	—	—	—
1 N.O.	A	O	O	X	M M M	52SC6CFA1	52SC6CGA1	52SC6CHA1	52SC6CKA1	52SC6CJA1	52SC6CMA1	<b>52SC6CEA1</b>	
					S---M	M	—	52SC6CWA1	52SC6CTA1	—	—	52SC6CYA1	—
					M M<----S	—	—	52SC6CUA1	52SC6CZA1	—	—	—	—
1 N.C.	B	X	O	O	S---M<---S	—	—	52SC6CVA1	—	—	—	—	
					M M M	52SC6CFA2	52SC6CGA2	52SC6CHA2	52SC6CKA2	52SC6CJA2	52SC6CMA2	<b>52SC6CEA2</b>	
1 N.C.	B	X	O	O	S---M	M	—	52SC6CWA2	52SC6CTA2	—	—	52SC6CYA2	—
1 N.O.	C	O	O	X	M M<----S	—	—	52SC6CUA2	52SC6CZA2	—	—	—	
1 N.C.	D	X	O	O	S---M<---S	—	—	52SC6CVA2	—	—	—	—	
1 N.O.	A	O	O	X	M M M	52SC6GFJ2K1	52SC6GGJ2K1	52SC6GHJ2K1	52SC6GKJ2K1	52SC6GJ2K1	52SC6GMJ2K1	<b>52SC6GEJ2K1</b>	
1 N.C.	B	X	O	O	M M M	52SC6GFJ2K1	52SC6GGJ2K1	52SC6GHJ2K1	52SC6GKJ2K1	52SC6GJ2K1	52SC6GMJ2K1	<b>52SC6GEJ2K1</b>	
1 N.C.	C	O	X	O	M M M	52SC6GFJ2K1	52SC6GGJ2K1	52SC6GHJ2K1	52SC6GKJ2K1	52SC6GJ2K1	52SC6GMJ2K1	<b>52SC6GEJ2K1</b>	

Contact Type	Contact	Switch Position				Type	Key Removal	
		Left	Left Center	Right Center	Right	M = Maintained S = Spring Return	Right	All Positions
							<b>4-Position Operator</b>	
No Contacts	—	—	—	—	—	M M M M	<b>52SC6HG</b>	52SC6HE
1 N.O.	A	X	O	O	O	M M M M	52SC6HGJ2K1	52SC6HEJ2K1
1 N.C.	B	O	X	O	O	M M M M	52SC6HGJ2K1	52SC6HEJ2K1
1 N.C.	C	O	O	X	O	M M M M	52SC6HGJ2K1	52SC6HEJ2K1
1 N.O.	A	O	O	O	X	M M M M	52SC6HGJ2K2	52SC6HEJ2K2
1 N.O.	B	X	O	O	O	M M M M	52SC6HGJ2K2	52SC6HEJ2K2
1 N.C.	C	O	X	O	O	M M M M	52SC6HGJ2K2	52SC6HEJ2K2
1 N.C.	D	O	O	X	O	M M M M	52SC6HGJ2K2	52SC6HEJ2K2

Note: X = Closed / O = Open

All Operators listed above are furnished with Lock No. 501CH

<sup>1)</sup> Readily available items are in bold.

This is a small representation of stocked items.

# Push Buttons & Signaling Devices

## 30mm Water, Oil Tight & Corrosion Resistant – Class 52

### Selector Push Button

1  
2  
3  
4  
5  
6  
7  
8  
9  
10

#### Selection Guide

### Selector Push Button

<b>Part Number</b>	<b>52</b>	<b>S</b>	<b>A</b>	<b>c</b>	<b>d</b>	<b>e</b>	<b>f</b> <sup>1</sup>
		<b>a</b>	<b>b</b>				



Selector Push Buttons

Finish	Style	Function	Color	Contacts	Part Number
Chrome	Flush Selector Push Button	2 Position CAM Q	Black	None	<b>52SA3Q1</b>
Chrome	Flush Selector Push Button	2 Position CAM R	Black	None	52SA3R1
Chrome	Flush Selector Push Button	2 Position CAM P	Black	None	52SA3P1

Readily available items are in **bold**.  
This is a small representation of stocked items.

<b>a</b>	<b>Code</b>	<b>Type</b>
	<b>S</b>	Selector Push Buttons
<b>b</b>	<b>Code</b>	<b>Finish</b>
	<b>A</b>	Chrome - Command 52
<b>c</b>	<b>Code</b>	<b>Style</b>
	<b>3</b>	Flush Button
	<b>4</b>	Extended Button - 1/2"

<b>d</b>	<b>Code</b>	<b>Function</b>
	<b>P</b>	2 Position: CAM P
	<b>Q</b>	2 Position: CAM Q
	<b>R</b>	2 Position: CAM R
	<b>S</b>	3 Position: CAM S

<b>e</b>	<b>Code</b>	<b>Color</b>
	<b>1</b>	Black
	<b>2</b>	Red

<b>f</b> <sup>1</sup>	<b>Code</b>	<b>Contact Blocks</b>							
		<b>CAM P (2 Selector Position)</b>							
		<b>Left</b>		<b>Center</b>		<b>Right</b>		<b>Contact Blocks</b>	<b>Mounting Position</b>
		<b>N</b>	<b>D</b>	<b>N/A</b>	<b>N/A</b>	<b>N</b>	<b>D</b>		
	<b>J0</b>	X	O	—	—	O	O	NC	Left
	<b>K0</b>	O	X	—	—	X	X	NO	Left
		<b>CAM Q (2 Selector Position)</b>							
		<b>Left</b>		<b>Center</b>		<b>Right</b>		<b>Contact Blocks</b>	<b>Mounting Position</b>
		<b>N</b>	<b>D</b>	<b>N/A</b>	<b>N/A</b>	<b>N</b>	<b>D</b>		
	<b>J0</b>	X	X	—	—	O	O	NC	Left
	<b>J1</b>	X	O	—	—	O	O	NC	Right
	<b>K0</b>	O	O	—	—	O	X	NO	Left
	<b>K1</b>	O	X	—	—	O	X	NO	Right
		<b>CAM R (2 Selector Position)</b>							
		<b>Left</b>		<b>Center</b>		<b>Right</b>		<b>Contact Blocks</b>	<b>Mounting Position</b>
		<b>N</b>	<b>D</b>	<b>N/A</b>	<b>N/A</b>	<b>N</b>	<b>D</b>		
	<b>J0</b>	X	X	—	—	X	O	NC	Left
	<b>J1</b>	X	O	—	—	X	X	NC	Left
	<b>K0</b>	O	O	—	—	O	X	NO	Right
	<b>K1</b>	O	X	—	—	O	O	NO	Right
		<b>CAM S (3 Selector Position)</b>							
		<b>Left</b>		<b>Center</b>		<b>Right</b>		<b>Contact Blocks</b>	<b>Mounting Position</b>
		<b>N</b>	<b>D</b>	<b>N</b>	<b>D</b>	<b>N</b>	<b>D</b>		
	<b>J0</b>	X	O	O	O	O	O	NC	Left
	<b>J1</b>	X	O	X	X	O	O	NC	Right
	<b>K0</b>	O	O	O	X	O	X	NO	Left
	<b>K1</b>	O	X	O	O	O	X	NO	Right

Note: X = Closed / O = Open

1 For operator without contact blocks leave position f blank





# Pushbutton Units and Indicator Lights

## 30mm Water, Oil Tight & Corrosion Resistant – Class 52

• Revised •  
11/15/14

### Special devices

#### Selection and ordering data

	Version	Ohms / color	Order no.	Pack		
	Potentiometer operator 2 Watts, 500 V AC/DC (NEMA Type 4)	50 150 250 500 750 1 K 2.5 K 5 K 10 K 15 K 25 K 50 K 100 K 150 K 250 K 500 K 1 M 1.5 M 2 M 5 M	52MA3B01 52MA3B03 52MA3B04 52MA3B06 52MA3B07 52MA3B08 52MA3B10 52MA3B12 52MA3B14 52MA3B15 52MA3B16 52MA3B18 52MA3B20 52MA3B21 52MA3B22 52MA3B24 52MA3B26 52MA3B27 52MA3B28 52MA3B31	1		
		2 Button maintained operator	black (flush) / red (flush) black (flush) / red (extended) black (flush) / yellow (mushroom) green (flush) / red (flush) green (flush) / red (extended) green (flush) / red (mushroom) green (flush) / green (mushroom)	52MA2A1A2 52MA2A1B2 52MA2A1D4 52MA2A3A2 52MA2A3B2 52MA2A3D2 52MA2A3D3	1	
		Button remains depressed when pushed	less caps	52MA2		
			Wobble stick 2.5" operator For use with 52BAJ (NC) contact block	red green grey	52ABW2 <sup>①</sup> 52ABW3 <sup>①</sup> 52ABW6 <sup>①</sup>	1
				Maintained toggle operator	52ABT	1

① For use with 52BAJ (NC) contact block

# Pushbutton Units and Indicator Lights

## 30mm Water, Oil Tight & Corrosion Resistant – Class 52

Cam selection

1  
2  
3  
4  
5  
6  
7  
8  
9  
10

### Selection and ordering data

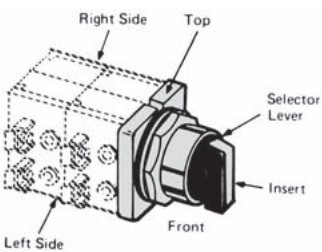

**Ordering Information**

- Contact blocks are ordered separately, [see page 10/205](#)
- Determine which table to use based upon the type of selector (non-illum selector switch-top, illum selector switch-middle, and selector pushbutton-bottom).
- Find the correct number of selector positions (2, 3 or 4 positions).
- Select the contact operation required for each selector position. X indicates the contacts are closed, while O indicates the contacts are open. (For the selector pushbutton, N=normal and D=depressed).
- Contact block must be assembled in position shown for each circuit application.
- Identify the CAM letter required for the chosen contact operation (only 1 CAM can be used per selector switch or selector pushbutton).
- Contact blocks must be assembled in the position shown for each circuit application. The mounting position is viewed from the front of the device.

**Ordering CAMs D, E or G**

- CAM D, E or G may be ordered at the same price by changing the 6th character of the selector catalog number. Example: Selector with D cam **52SX2DAB**.

**Size Requirements**

- C CAM on spring return selectors is limited to 4 contact blocks.
- Selector operators in enclosures are limited to depth of 1 contact block. (2 blocks wide).

### Non-illuminated and keyed selector switches (viewed from front)

2 Selector Positions				Contact Blocks	CAM	Mounting		
Left		Right	Left			Right		
X		O		NC (52BAJ)	A	L	or R	
O		X		NO (52BAK)	A	L	or R	
3 Selector Positions				Contact Blocks	CAM	Mounting		
Left	Center	Right	Left			Right		
X		O		NO (52BAK)	B		R	
O		X		NO (52BAK)	B	L		
X	X	O		NC (52BAJ)	B	L		
O	X	X		NC (52BAJ)	B		R	
X	O	X		2NO (2-52BAK)	B	L	and R	
X	O	O		NC (52BAJ)	C	L	or R	
O	O	X		NO (52BAK)	C	L	or R	
O	X	O		NC (52BAJ)	D	L	or R	
O	O	X		NO (52BAK)	D	L	or R	
X	O	O		NO (52BAK)	E	L	or R	
O	X	O		NC (52BAJ)	E	L	or R	
X	O	O		NC (52BAJ)	G	L		
O	X	O		NC (52BAJ)	G		R	
O	O	X		NO (52BAK)	G	L	or R	
4 Selector Positions					Contact Blocks	CAM	Mounting	
Left	Left Center	Right Center	Right	Left			Right	
X	O	O	O	NO (52BAK)	H		R	
O	X	O	O	NC (52BAJ)	H	L		
O	O	X	O	NC (52BAJ)	H		R	
O	O	O	X	NO (52BAK)	H	L		

### Illuminated selector switches (viewed from front)

2 Selector Positions				Contact Blocks	CAM	Mounting	
Left		Right	Left			Right	
X		O		NC (52BAJ)	A	L	
O		X		NO (52BAK)	A	L	
3 Selector Positions				Contact Blocks	CAM	Mounting	
Left	Center	Right	Left			Right	
O	O	X		NC (52BAJ)	B		R
O	X	O		NO (52BAK)	B		R
X	O	O		NC (52BAJ)	C	L	
O	O	X		NO (52BAK)	C	L	

### Selector Pushbuttons (viewed from front)

2 Selector Positions						Contact Blocks	CAM	Mounting	
Left			Right		Left			Right	
N	D		N	D					
X	O		O	O	NC (52BAJ)	Q			R
X	X		O	O	NC (52BAJ)	Q	L		
O	X		O	X	NO (52BAK)	Q			R
O	O		O	X	NO (52BAK)	Q	L		
X	O		O	O	NC (52BAJ)	P	L	or	R
O	X		X	X	NO (52BAK)	P	L	or	R
X	X		X	O	NC (52BAJ)	R	L		
X	O		X	X	NC (52BAJ)	R			R
O	X		O	O	NO (52BAK)	R			R
O	O		O	X	NO (52BAK)	R	L		
3 Selector Positions						Contact Blocks	CAM	Mounting	
Left		Center	Right		Left			Right	
N	D	N	D	N	D				
X	O	O	O	O	O	NC (52BAJ)	S	L	
X	O	X	X	O	O	NC (52BAJ)	S		R
O	X	O	O	O	X	NO (52BAK)	S		R
O	O	O	X	O	X	NO (52BAK)	S	L	

# Pushbutton Units and Indicator Lights

## 30mm Water, Oil Tight & Corrosion Resistant – Class 52

### Custom selector switch designs

#### Selection and ordering data

##### Assembled Non-illuminated Selector Switches

- Determine contact block and location from above.
- Select block suffix. Ex: **J = 52BAJ**.
- Now select position suffix.
- **1-52BAJ** block mounted on right side, suffix will be **J 1**.
- Additional suffixes allow for multiple quantities and locations.
- Repeat process for next block if required.
- Add list price of blocks to operator list price.
- Consult factory for delivery.

**Example 1:**    X O O  
                   O O X  
 HAND-OFF-AUTO Maintained Switch  
 Catalog No **52SA2CAB A 1 = 52A2CABA1**  
 (**52BJK** block mounted on right side)

**Example 2:**    X O O **52BAJ (L)**  
                   O X O **52BAJ (R)**  
                   O O X **52BAK (L or R) }K1**  
 G Cam required  
 Catalog No **52SA2GAB J2 K1 = 52SA2GABJ2K1**

Block Suffix	Position Suffix	
	Suffix	Quantity and Location
		Left      Right
A = 1 NO - 1 NC, <b>52BJK</b>	0	1      —
E = NC Late Break, <b>52BAE</b>	1	—      1
H = NO Early Make, <b>52BAH</b>	2	1      1
J = NC, <b>52BAJ</b>	3	2      —
K = NO, <b>52BAK</b>	4	—      2
	5	2      1
	6	1      2
	7	2      2
	8	3      —
	9	—      3

• Revised •  
07/15/16

# Pushbutton Units and Indicator Lights

## 30mm Water, Oil Tight & Corrosion Resistant – Class 52

### Accessories and spare parts

1

2

3

4

5

6





7

8

9

10

#### Selection and ordering data

Version	Suitable for	Color	Order no.
 <b>Flush actuator lens cap</b>	For flush type, non-illuminated pushbuttons bag of 20 caps	black red green yellow blue gray orange kit- all colors	<b>52RA1A1</b> <b>52RA1A2</b> <b>52RA1A3</b> <b>52RA1A4</b> <b>52RA1A5</b> <b>52RA1A6</b> <b>52RA1A8</b> <b>52RA1AN</b>
 <b>Extended actuator lens cap</b>	For extended type, non-illuminated pushbuttons bag of 20 caps	black red green yellow blue gray orange 1 of each color cap	<b>52RA1B1</b> <b>52RA1B2</b> <b>52RA1B3</b> <b>52RA1B4</b> <b>52RA1B5</b> <b>52RA1B6</b> <b>52RA1B8</b> <b>52RA1BN</b>
 <b>Mushroom head cap - Plastic set-screw type</b> replacement caps are for discontinued 52PB9 and 52PX9 operators only	For large 2 1/2" (63.5mm) type, set screw non-illuminated mushroom pushbuttons  For small 1 5/8" (41.3mm) type, non-illuminated mushroom pushbuttons	black red green yellow blue gray orange 1 kit of each color cap  black red green yellow blue gray orange 1 of each color cap	<b>52RB3E1</b> <b>52RB3E2</b> <b>52RB3E3</b> <b>52RB3E4</b> <b>52RB3E5</b> <b>52RB3E6</b> <b>52RB3E8</b> <b>52RB3EN</b>  <b>52RB3D1</b> <b>52RB3D2</b> <b>52RB3D3</b> <b>52RB3D4</b> <b>52RB3D5</b> <b>52RB3D6</b> <b>52RB3D8</b> <b>52RB3DN</b>
 <b>Mushroom head cap - Metal set-screw type</b>	For small 1 5/8" (41.3mm) type, set screw non-illuminated mushroom pushbuttons	chrome red green	<b>52RB3FC</b> <b>52RB3F2</b> <b>52RB3F3</b>
 <b>Replacement Lens for Indicator Lights</b>	For catalog numbers starting with 52PL or 52BL <sup>①②</sup> Plastic  Glass	red green blue amber clear white 1 of each color red green blue amber clear white 1 of each color	<b>52RA4S2</b> <b>52RA4S3</b> <b>52RA4S5</b> <b>52RA4S9</b> <b>52RA4SA</b> <b>52RA4SB</b> <b>52RA4SN</b> <b>52RA4T2</b> <b>52RA4T3</b> <b>52RA4T5</b> <b>52RA4T9</b> <b>52RA4TA</b> <b>52RA4TB</b> <b>52RA4TN</b>
 <b>Replacement Lens for Push to Test/Illuminated Pushbuttons</b>	For catalog numbers starting with 52PT or 52BT <sup>③</sup> Plastic	red green blue amber clear white	<b>52RA5S2</b> <b>52RA5S3</b> <b>52RA5S5</b> <b>52RA5S9</b> <b>52RA5SA</b> <b>52RA5SB</b>

① To order replacement lens for indicator lights starting with 52PA, 52PE, or 52PX, change the 6th digit to P for plastic and G for glass.

② It is possible to retrofit catalog numbers starting with 52PA, 52PE and 52PX with the replacement lens. The new lens have concentric ribs for improved light distribution.

③ To order replacement lens for push to test / illuminated pushbuttons starting with 52PA, 52PE, or 52PX, change the 6th digit to a P.







# Pushbutton Units and Indicator Lights

## 30mm Water, Oil Tight & Corrosion Resistant – Class 52

• Revised •  
07/15/16

### Accessories and spare parts

#### Selection and ordering data

Version	Suitable for	Color	Order no.
<b>Mushroom head push pull illuminated plastic screw-on type</b>	For small 1 3/4" type, push-pull units	red green amber	<b>52RC3JR</b> <b>52RC3JS</b> <b>52RC3JT</b>
	For large 2 1/2" type, push-pull units	red green amber	<b>52RC3KR</b> <b>52RC3KS</b> <b>52RC3KT</b>
 <b>Mushroom head push pull illuminated metal screw-on type</b>	Chrome, for small 1 3/4" type, push-pull units	red green amber white	<b>52RB3H2</b> <b>52RB3H3</b> <b>52RB3H9</b> <b>52RB3HB</b>
	BlackMax, for small 1 3/4" type, push-pull units	red green amber white	<b>52RX3H2</b> <b>52RX3H3</b> <b>52RX3H9</b> <b>52RX3HB</b>
 <b>Mushroom head push pull non-illuminated plastic screw-on type</b>	For small 1 3/4" type, push-pull units (catalog numbers starting with 52PP, 52BP, 52PM9 or 52BM9)①	black red green yellow blue gray orange 1 of each color	<b>52RC3D1</b> <b>52RC3D2</b> <b>52RC3D3</b> <b>52RC3D4</b> <b>52RC3D5</b> <b>52RC3D6</b> <b>52RC3D8</b> <b>52RC3DN</b>
	For large 2 1/2" type, push-pull units (catalog numbers starting with 52PP, 52BP, 52PM9 or 52BM9)①	black red green yellow blue gray orange 1 of each color	<b>52RC3E1</b> <b>52RC3E2</b> <b>52RC3E3</b> <b>52RC3E4</b> <b>52RC3E5</b> <b>52RC3E6</b> <b>52RC3E8</b> <b>52RC3EN</b>
 <b>Mushroom head push pull non-illuminated metal screw-on type</b>	For small 1 3/4" type, push-pull units (catalog numbers starting with 52PP or 52BP)①	red green chrome	<b>52RC3F2</b> <b>52RC3F3</b> <b>52RC3FC</b>
 <b>Twist to release head illuminated plastic screw-on type</b>	For small twist to release units	red green amber	<b>52RC3RR</b> <b>52RC3RS</b> <b>52RC3RT</b>
 <b>Twist to release head non-illuminated plastic screw-on type</b>	For small twist to release units	red green yellow	<b>52RC3R2</b> <b>52RC3R3</b> <b>52RC3R4</b>
 <b>Replacement lens kit for illuminated selector switches (Knob with Insert)</b>		red green blue amber clear white	<b>52RA6P2</b> <b>52RA6P3</b> <b>52RA6P5</b> <b>52RA6P9</b> <b>52RA6PA</b> <b>52RA6PB</b>
 <b>Lever inserts</b>	<b>Short lever</b>	red green yellow blue gray orange white	<b>52RA2A2</b> <b>52RA2A3</b> <b>52RA2A4</b> <b>52RA2A5</b> <b>52RA2A6</b> <b>52RA2A8</b> <b>52RA2AB</b>
	<b>Long lever</b>	red green yellow blue gray orange white	<b>52RA2B2</b> <b>52RA2B3</b> <b>52RA2B4</b> <b>52RA2B5</b> <b>52RA2B6</b> <b>52RA2B8</b> <b>52RA2BB</b>

① For push-pull units whose catalog numbers that start with 52PX, 52PA or 52PE, replacement heads are available. Order from the 52RB type "Mushroom head pushbutton cap" section on page 10/205.











# Pushbutton Units and Indicator Lights

## 30mm Water, Oil Tight & Corrosion Resistant – Class 52

### Accessories and spare parts

1  
2  
3  
4  
5  
6  
7  
8  
9  
10

#### Selection and ordering data

Version	Suitable for	Color	Order no.
 <b>Protective boot</b> Offers protection from ice and foreign substances from interfering with button operation	Flush pushbutton operations	clear black	<b>52AABA</b> <b>52AAB1</b>
 <b>Guards</b> Prevents accidental operation	Non-illuminated basic pushbuttons  1 5/8" mushroom pushbuttons, 1 3/4" push-pull units <sup>①</sup> , and twist to release units Push to test/illuminated pushbutton and indicator lights	chrome blackmax  chrome blackmax  chrome blackmax	<b>52AAGP</b> <b>52AXGP</b>  <b>52AAGM</b> <b>52AXGM</b>  <b>52AAGL</b> <b>52AXGL</b>
 <b>EMERGENCY-STOP Lock Out</b>	Class 52 Illuminated Mushroom Head Pushbuttons; 304 Stainless Steel	chrome (304 SS)	<b>52AALE</b>
 <b>EMERGENCY-STOP Backing Ring</b>	Yellow 90mm E-STOP Backing Ring		<b>52AAR</b>
 <b>Locknuts</b> Replacement front ring	Non-illuminated basic pushbuttons  Non-illuminated mushroom pushbuttons  Push-pull and twist-to-release units (only for push-pull units starting with 52PP or 52BP) <sup>②</sup> Indicator Lights  Selector switches	chrome blackmax  chrome blackmax  chrome blackmax  blue amber  chrome blackmax	<b>52AANP</b> <b>52AXNP</b>  <b>52AANL</b> <b>52AXNL</b>  <b>52CANP</b> <b>52CXNP</b>  <b>52AANL</b> <b>52AXNL</b>  <b>52AANS</b> <b>52AXNS</b>
<b>Mounting Accessories</b>	Class 52 Trim Washer Kit (Set of 10 pcs) Class 52 Washer Kit (Include 2-Neoprene Gaskets, 1-Trim Washer, 1-Index Locking Ring (chrome))	chrome	<b>52AAQ</b> <b>52AAD</b>
<b>Padlock attachments</b>	Non-illuminated basic pushbuttons	flush extended	<b>52AALA</b> <b>52AALB</b>
 <b>Padlock cover</b> Lock devices in off position	Pushbuttons, selector switches, and non-illuminated mushroom heads		<b>52AALS</b>
 <b>Lock nut wrench</b>	All devices		<b>52MAWB</b>
 <b>Hole plugs</b>		corrosion resistant steel, grey stainless steel	<b>52AAH6</b> <b>52ABH6</b> <b>52ABHS</b>
<b>Spare keys</b> (Kit includes 1 Key)	Class 52 Standard Keyed Selector Switch. Keyed Selector Switch ordered with Suffix X302. Keyed Selector Switch ordered with Suffix X301. Keyed Selector Switch ordered with Suffix X300. Keyed Selector Switch ordered with Suffix X299. Keyed Selector Switch ordered with Suffix X298.	501CH 506CH 547CH 548CH 549CH 550CH	<b>52KEY-501CH</b> <b>52KEY-506CH</b> <b>52KEY-547CH</b> <b>52KEY-548CH</b> <b>52KEY-549CH</b> <b>52KEY-550CH</b>
<b>Grounding kit</b>	All devices		<b>52AL109145</b>
 <b>Touchsafe contact blocks with gold flashing</b>  52 BAJ 1 NO 1 NC 1 NO - 1 NC  52 BAK 1 NO early make 1 NC late break 1 NO - 1 NC  52 BAR 1 NC extra late break	closes before 52BAK opens after 52BAJ Reed switch; UL listed for class 1 division 2; .25A Max, 200V AC, 10 Watt max .5A Max, 200V DC, 10 Watt max		<b>52BAK</b> <b>52BAJ</b> <sup>③</sup> <b>52BJK</b> <sup>④</sup> <b>52BAH</b> <b>52BAE</b> <b>52BAR</b> <sup>④</sup>  <b>52BAU</b>

① These can also be used with the 1 5/8" push-pull devices.

② For push-pull units starting with part numbers 52PA, 52PE or 52PX, replacement locknuts can be ordered using 52AANL (Chrome) and 52AXNL (BlackMax).

③ Hermetically Sealed

④ ⊕ Positive opening according to IEC 60947-5-1, Appendix K.

# Pushbutton Units and Indicator Lights

## 30mm Water, Oil Tight & Corrosion Resistant – Class 52

• Revised •  
08/15/14

### Accessories and spare parts

#### Selection and ordering data

Version	Suitable for	Lamp voltage	Color	Order no.
<b>Lamps with screw connection, miniature bayonet (BA 9s style)</b>				
<b>Incandescent lamps,</b>				
	Flashing, type 267 lamp (replaces 755 lamp)	51, 52	6 V	<b>52AABNF</b>
	6V type 755 lamp (Rated 150 mA)	51, 52	6 V	<b>52AABN</b>
	12V type 756 (Rated 80 mA)	51, 52	12 V	<b>52AACN</b>
	24V type 757 (Rated 80 mA)	51, 52	24 V	<b>52AADN</b>
	48V, 2W	52	48 V	<b>3SB1902-1AP</b>
	60V, 2W	52	60 V	<b>3SR9424</b>
	120V, 2.5W, type #120MB (Rated 250 mA)	52	120 V	<b>52AAENC1</b>
Neon (uses resistors) type B2A (NE-51H)	52	120 V	<b>52AAPN</b>	
<b>Candelabra, 120V, 3W, Full voltage type 3S6/5</b>	52 older revision styles	120 V		<b>52AAENC</b>
<b>LED bulbs<sup>①</sup></b>				
LED, BA9s type <sup>②</sup>	Class 52	6 V AC/DC 24 V AC/DC 120 V AC/DC		<b>52AEB□</b> <b>52AED□</b> <b>52AEE□</b>
Super-Bright LED <sup>②</sup>	Class 52	6 V AC/DC 24 V AC/DC 120 V AC/DC 120 V DC		<b>52AEB□7</b> <b>52AED□7</b> <b>52AEE□7</b> <b>52AEV□7</b>
<b>LED lighting module with integrated LED.</b>				
Single LED (Rated 35 mA Maximum)	Class 52	24 V AC/DC 120 V AC 240 V AC		<b>52AAIL□</b> <b>52AAIM□</b> <b>52AAIN□</b>
<b>Full voltage lighting module accessory with BA9s type lamp<sup>①</sup></b>				
LED <sup>②</sup>	Class 52	6 V AC/DC 24 V AC/DC 120 V AC/DC		<b>52AAF□B</b> <b>52AAF□D</b> <b>52AAF□E</b>
Super-Bright LED <sup>②</sup>	Class 52	6 V AC/DC 24 V AC/DC 120 V AC/DC		<b>52AAF□Y</b> <b>52AAF□D□Y</b> <b>52AAF□E□Y</b>
Incandescent bulb	Class 52	6 V AC/DC 24 V AC/DC 120 V AC/DC		<b>52AAF□B</b> <b>52AAF□D</b> <b>52AAF□E</b>
<b>Transformer lighting module accessory with BA9s type lamp<sup>①</sup></b>				
LED	Class 52	120 V AC 240 V AC 480 V AC 600 V AC		<b>52AAT□G□B</b> <b>52AAT□H□B</b> <b>52AAT□J□B</b> <b>52AAT□K□B</b>
Super-Bright LED	Class 52	120 V AC 240 V AC 480 V AC 600 V AC		<b>52AAT□G□Y</b> <b>52AAT□H□Y</b> <b>52AAT□J□Y</b> <b>52AAT□K□Y</b>
Incandescent bulb	Class 52	120 V AC 240 V AC 480 V AC 600 V AC		<b>52AAT□GN</b> <b>52AAT□HN</b> <b>52AAT□JN</b> <b>52AAT□KN</b>

Color options:

red  
green  
yellow/amber  
blue  
white/clear

2  
3  
4  
5  
B

① Standard LED lamps are recommended for indoor applications, Super-Bright LED Lamps are recommended for outdoor applications.

② 6V, 24V (Super Bright only) and 120V are currently AC only. Replaced by AC/DC rated versions end of 2014.

# Pushbutton Units and Indicator Lights

## 30mm Water, Oil Tight & Corrosion Resistant – Class 52

### Dimensional drawings

1

2

3

4

5

6

7

8

9

10

Non-Illuminated Push-Pull  
Metal Mushroom Head

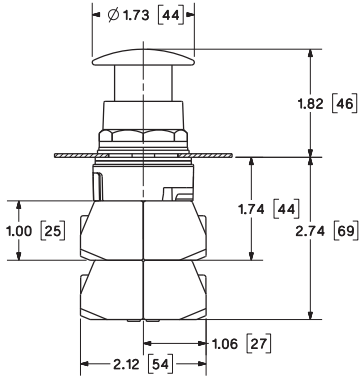

Non-Illuminated Push-Pull  
Small Plastic Mushroom Head

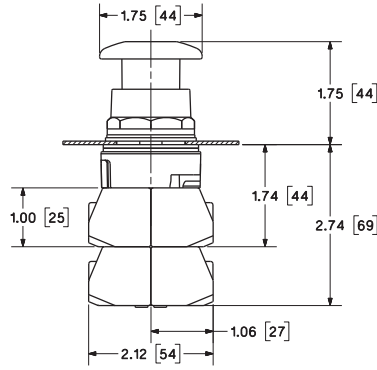

Non-Illuminated Push-Pull  
Large Plastic Mushroom Head

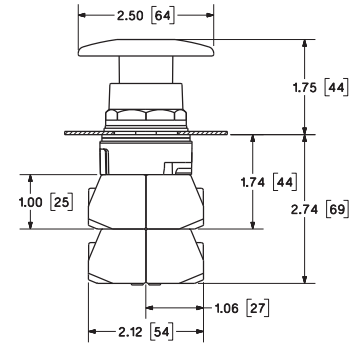

Illuminated Push-Pull  
Metal Mushroom Head

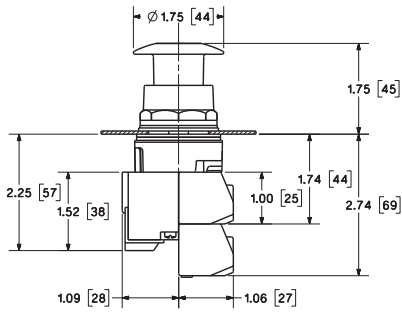

Fully Illuminated Push-Pull  
Small Plastic Mushroom Head

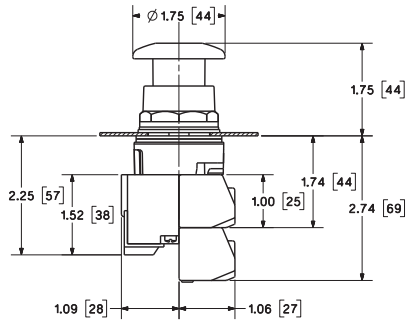

Illuminated Push-Pull  
Large Plastic Mushroom Head

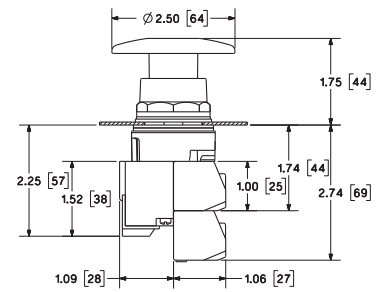

Non-Illuminated Twist Release  
Plastic Mushroom Head

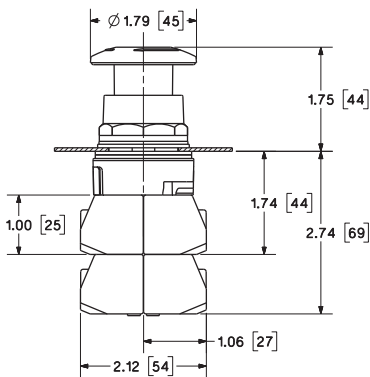

Illuminated Twist Release  
Plastic Mushroom Head

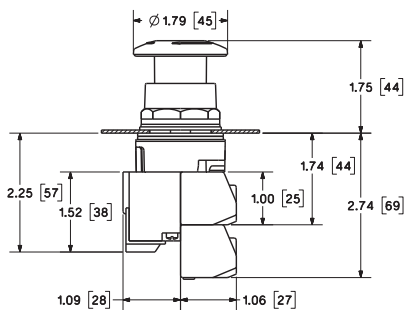

Illuminated Pushbutton Flush Lens  
Illuminated Pushbutton Extended Lens  
Illuminated Push to Test

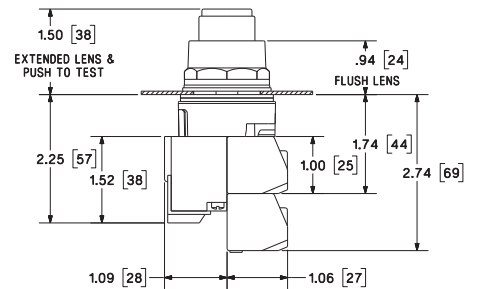

# Pushbutton Units and Indicator Lights

## 30mm Water, Oil Tight & Corrosion Resistant – Class 52

### Dimensional drawings

Selector Switch  
Non-Illuminated

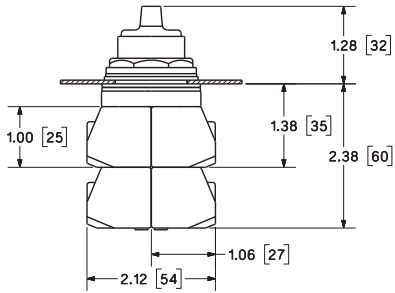

Selector Switch  
Illuminated

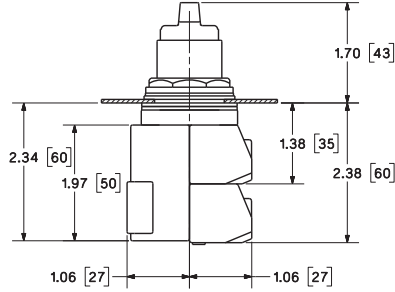

Indicator Light  
Plastic Lens

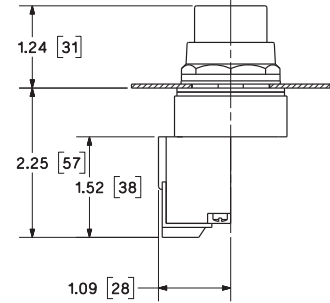

Momentary Pushbutton  
Non-Illuminated Flush Cap

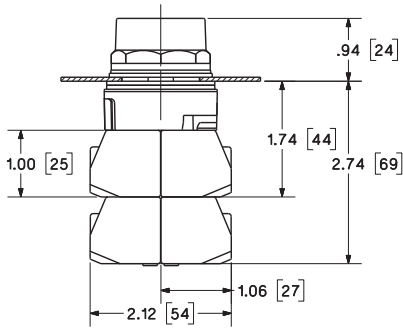

Momentary Pushbutton  
Non-Illuminated Raised Cap

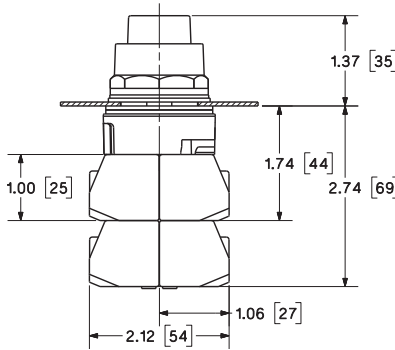

Indicator Light  
Glass Lens

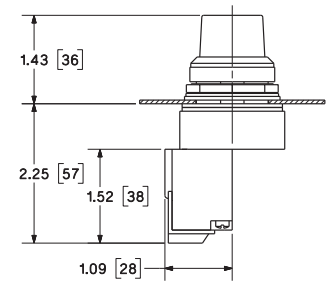

Momentary Pushbutton  
Metal Mushroom Head

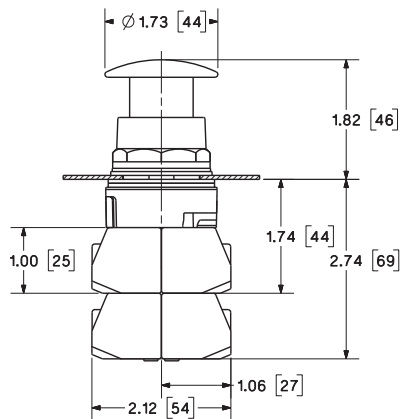

Momentary Pushbutton  
Small Plastic Mushroom Head

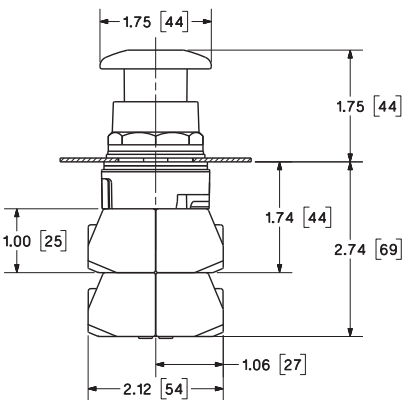

Momentary Pushbutton  
Large Plastic Mushroom Head

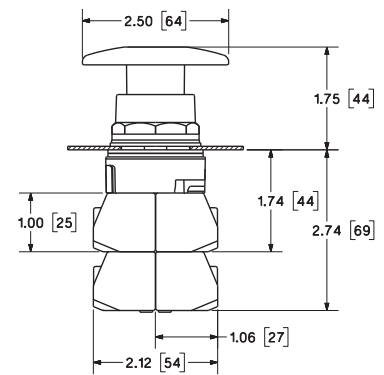

# Pushbutton Units and Indicator Lights

## 30mm Water, Oil Tight & Corrosion Resistant – Class 52

### Dimensional drawings

1

2

3

4

5

6

7

8

9

10

Illuminated Momentary Pushbutton  
Metal Mushroom Head

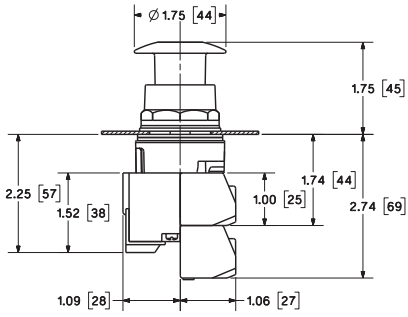

Illuminated Momentary Pushbutton  
Small Plastic Mushroom Head

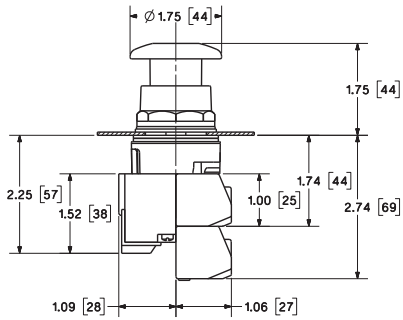

Illuminated Momentary Pushbutton  
Large Plastic Mushroom Head

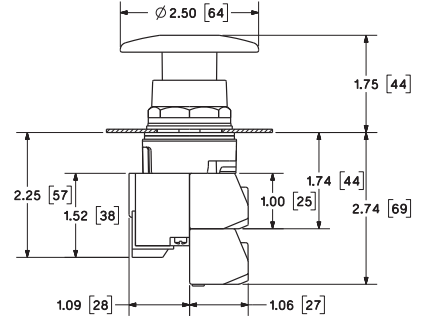

Selector Switch  
Keyed

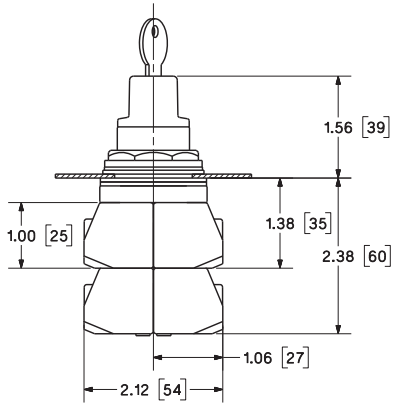

Wobble Switch

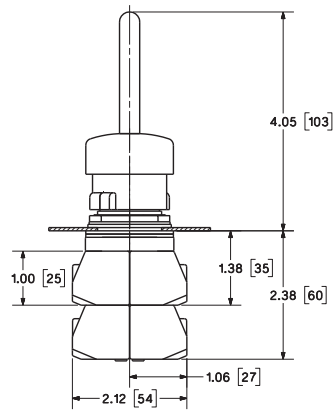

Potentiometer Switch

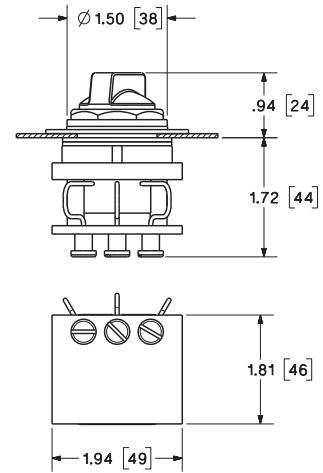

Toggle Switch

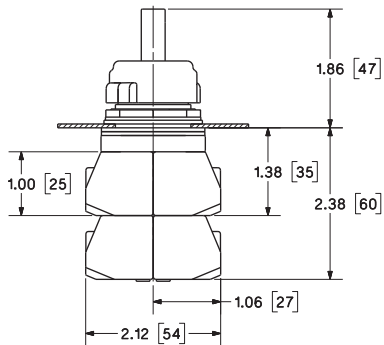

Selector Pushbutton Switch  
Flush Cap

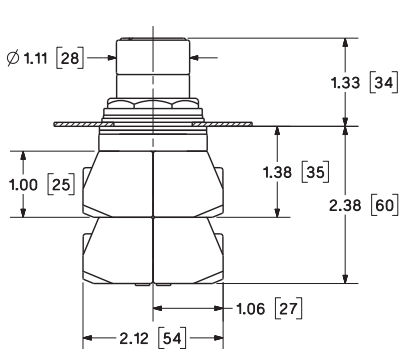

Selector Pushbutton Switch  
Raised Cap

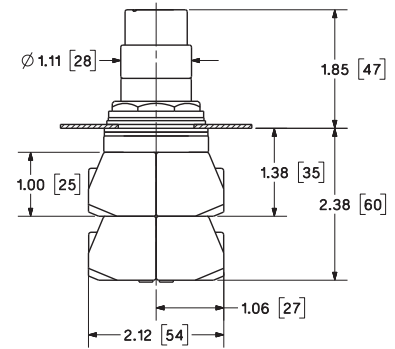

# Pushbutton Units and Indicator Lights

## 30mm Water, Oil Tight & Corrosion Resistant – Class 52

### Dimensional drawings

Momentary Pushbutton Guard  
Illuminated Push to Test Guard

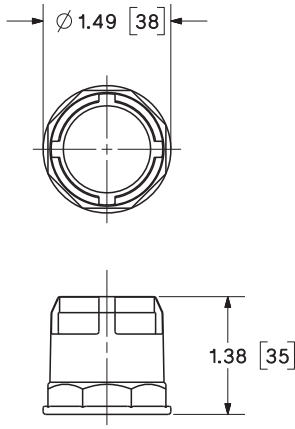

Mushroom Head Guard

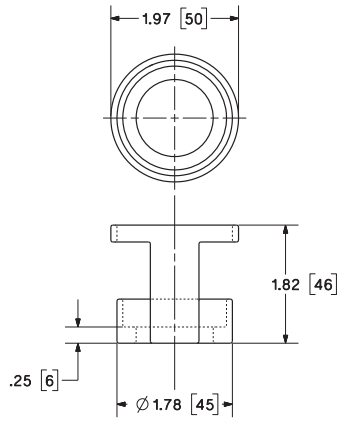

Contact Block

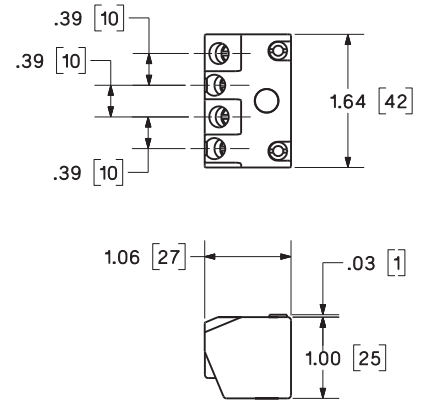

Large Metal Legend Plate

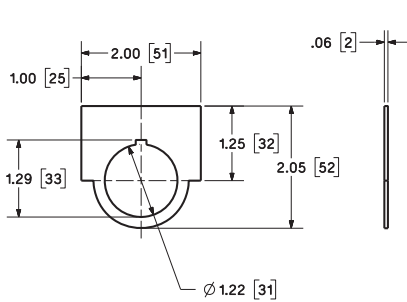

Automotive Metal Legend Plate

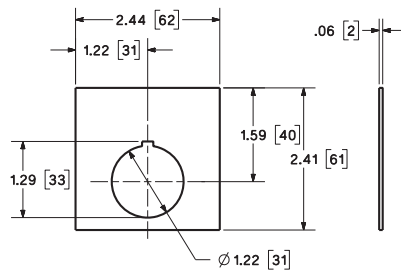

Large Plastic Legend Plate

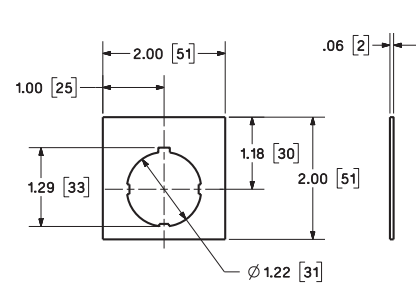



# Pushbutton Units and Indicator Lights

## 30mm Water, Oil Tight & Corrosion Resistant - Class 52

### Class 52 oiltight pushbutton stations

1  
2  
3  
4  
5  
6  
7  
8  
9  
10

#### Selection and ordering data

	Actuator identification C = top device in station B = middle device in station A = bottom device in station	Degree of protection <sup>①</sup>	Contact / voltage	No. of command points	Order no.	Pack  Unit
1 unit control station 	A = Momentary flush pushbutton black, label "START"	NEMA 12	1NO - 1NC	1	<b>52C101A</b>	
	A = Momentary raised pushbutton red, label "STOP"	NEMA 12	1NO - 1NC	1	<b>52C103A</b>	
	A = Momentary mushroom head red, label "STOP"	NEMA 12	1NO - 1NC	1	<b>52C104A</b>	
	A = Maintained metal mushroom head red, label "EMERGENCY STOP"	NEMA 12	1NO - 1NC	1	<b>52C117A</b>	
	A = 2 position selector switch "OFF-ON"	NEMA 12	1NO - 1NC	1	<b>52C159A</b>	
	A = 3 position selector switch "HAND-OFF-AUTO"	NEMA 12	1NO - 1NC	1	<b>52C156A</b>	
	A = Indicator light, red	NEMA 12	120V Transformer type	1	<b>52C131A</b>	
	A = Indicator light, green	NEMA 12	120V Transformer type	1	<b>52C135A</b>	
	A = Momentary flush pushbutton black, label "START"	NEMA 4X Stainless Steel	1NO - 1NC	1	<b>52C101S</b>	
	A = Momentary raised pushbutton red, label "STOP"	NEMA 4X Stainless Steel	1NO - 1NC	1	<b>52C103S</b>	
	A = Momentary mushroom head red, label "STOP"	NEMA 4X Stainless Steel	1NO - 1NC	1	<b>52C104S</b>	
	A = Maintained metal mushroom head red, label "EMERGENCY STOP"	NEMA 4X Stainless Steel	1NO - 1NC	1	<b>52C116S</b>	
	A = 2 position selector switch "OFF-ON"	NEMA 4X Stainless Steel	1NO - 1NC	1	<b>52C159S</b>	
	A = 3 position selector switch "HAND-OFF-AUTO"	NEMA 4X Stainless Steel	1NO - 1NC	1	<b>52C156S</b>	
	A = Momentary flush pushbutton black, label "START"	NEMA 4X Fiberglass	1NO - 1NC	1	<b>52C101X</b>	
	A = Momentary raised pushbutton red, label "STOP"	NEMA 4X Fiberglass	1NO - 1NC	1	<b>52C103X</b>	
	A = Momentary mushroom head red, label "STOP"	NEMA 4X Fiberglass	1NO - 1NC	1	<b>52C104X</b>	
	A = Maintained metal mushroom head red, label "EMERGENCY STOP"	NEMA 4X Fiberglass	1NO - 1NC	1	<b>52C116X</b>	
	A = 2 position selector switch "OFF-ON"	NEMA 4X Fiberglass	1NO - 1NC	1	<b>52C159X</b>	
A = 3 position selector switch "HAND-OFF-AUTO"	NEMA 4X Fiberglass	1NO - 1NC	1	<b>52C156X</b>		
2 unit control station 	B = Momentary flush pushbutton black, label "START" A = Momentary raised pushbutton red, label "STOP"	NEMA 12	1NO, 1NC 1NO, 1NC	2	<b>52C201A</b>	
	B = Momentary flush pushbutton black, label "START" A = Momentary Mushroom head pushbutton red, label "STOP"	NEMA 12	1NO, 1NC 1NO, 1NC	2	<b>52C202A</b>	
	B = Momentary flush pushbutton, label "FORWARD" A = Momentary flush pushbutton, label "REVERSE"	NEMA 12	1NO, 1NC 1NO, 1NC	2	<b>52C204A</b>	
	B = Momentary flush pushbutton, label "UP" A = Momentary flush pushbutton, label "DOWN"	NEMA 12	1NO, 1NC 1NO, 1NC	2	<b>52C223A</b>	
	B = Indicator light, red, label "RUN" A = Maintained selector switch, label "HAND-OFF-AUTO"	NEMA 12	120V Transformer type	2	<b>52C224A</b>	
	B = Indicator light, red A = Indicator light, green	NEMA 12	120V Transformer type	2	<b>52C230A</b>	
	B = Momentary flush pushbutton black, label "START" A = Momentary raised pushbutton red, label "STOP"	NEMA 4X Stainless Steel	1NO, 1NC 1NO, 1NC	2	<b>52C201S</b>	
	B = Momentary flush pushbutton black, label "START" A = Momentary Mushroom head pushbutton red, label "STOP"	NEMA 4X Stainless Steel	1NO, 1NC 1NO, 1NC	2	<b>52C202S</b>	
	B = Momentary flush pushbutton, label "UP" A = Momentary flush pushbutton, label "DOWN"	NEMA 4X Stainless Steel	1NO, 1NC 1NO, 1NC	2	<b>52C223S</b>	
	B = Indicator light, red, label "RUN" A = Maintained selector switch, label "HAND-OFF-AUTO"	NEMA 4X Stainless Steel	120V Transformer type 1NO, 1NC	2	<b>52C224S</b>	
	B = Momentary flush pushbutton black, label "START" A = Momentary raised pushbutton red, label "STOP"	NEMA 4X Fiberglass	1NO, 1NC 1NO, 1NC	2	<b>52C201X</b>	
	B = Momentary flush pushbutton black, label "START" A = Momentary Mushroom head pushbutton red, label "STOP"	NEMA 4X Fiberglass	1NO, 1NC 1NO, 1NC	2	<b>52C202X</b>	
	B = Momentary flush pushbutton, label "UP" A = Momentary flush pushbutton, label "DOWN"	NEMA 4X Fiberglass	1NO, 1NC 1NO, 1NC	2	<b>52C223X</b>	
	B = Indicator light, red, label "RUN" A = Maintained selector switch, label "HAND-OFF-AUTO"	NEMA 4X Fiberglass	120V Transformer type 1NO, 1NC	2	<b>52C224X</b>	

① NEMA 4X Stainless Steel Enclosure is 304 SS.

# Pushbutton Units and Indicator Lights

## 30mm Water, Oil Tight & Corrosion Resistant - Class 52

### Class 52 oiltight pushbutton stations

#### Selection and ordering data

Actuator identification	Degree of protection <sup>①</sup>	Contact / voltage	No. of command points	Order no.	Pack	
3 unit control station 	C = Indicator light, red	NEMA 12	120V 1NO, 1NC	3	<b>52C307A</b>	Unit
	B = Momentary flush pushbutton black, label "START" A = Momentary raised pushbutton red, label "STOP"		1NO, 1NC 1NO, 1NC			
	C = Momentary flush pushbutton black, label "FORWARD" B = Momentary flush pushbutton black, label "REVERSE" A = Momentary raised pushbutton red, label "STOP"	NEMA 12	1NO, 1NC 1NO, 1NC 1NO, 1NC	3	<b>52C301A</b>	
C = Momentary flush pushbutton black, label "UP" B = Momentary flush pushbutton black, label "DOWN" A = Momentary raised pushbutton red, label "STOP"	NEMA 12	1NO, 1NC 1NO, 1NC 1NO, 1NC	3	<b>52C332A</b>		
C = Momentary flush pushbutton black, label "OPEN" B = Momentary flush pushbutton black, label "CLOSE" A = Momentary raised pushbutton red, label "STOP"	NEMA 12	1NO, 1NC 1NO, 1NC 1NO, 1NC	3	<b>52C333A</b>		
C = Momentary flush pushbutton black, label "HI" B = Momentary flush pushbutton, black label "LOW" A = Momentary raised pushbutton red, label "STOP"	NEMA 12	1NO, 1NC 1NO, 1NC 1NO, 1NC	3	<b>52C334A</b>		
C = Indicator light, red	NEMA 4X Stainless Steel	120V 1NO, 1NC	3	<b>52C307S</b>		
B = Momentary flush pushbutton black, label "START" A = Momentary raised pushbutton red, label "STOP"		1NO, 1NC 1NO, 1NC				
C = Momentary flush pushbutton black, label "FORWARD" B = Momentary flush pushbutton black, label "REVERSE" A = Momentary raised pushbutton red, label "STOP"	NEMA 4X Stainless Steel	1NO, 1NC 1NO, 1NC 1NO, 1NC	3	<b>52C301S</b>		
C = Momentary flush pushbutton black, label "UP" B = Momentary flush pushbutton black, label "DOWN" A = Momentary raised pushbutton red, label "STOP"	NEMA 4X Stainless Steel	1NO, 1NC 1NO, 1NC 1NO, 1NC	3	<b>52C332S</b>		
C = Momentary flush pushbutton black, label "OPEN" B = Momentary flush pushbutton black, label "CLOSE" A = Momentary raised pushbutton red, label "STOP"	NEMA 4X Stainless Steel	1NO, 1NC 1NO, 1NC 1NO, 1NC	3	<b>52C333S</b>		
C = Momentary flush pushbutton black, label "HI" B = Momentary flush pushbutton, black label "LOW" A = Momentary raised pushbutton red, label "STOP"	NEMA 4X Stainless Steel	1NO, 1NC 1NO, 1NC 1NO, 1NC	3	<b>52C334S</b>		
C = Indicator light, red	NEMA 4X Fiberglass	120V 1NO, 1NC	3	<b>52C307X</b>		
B = Momentary flush pushbutton black, label "START" A = Momentary raised pushbutton red, label "STOP"		1NO, 1NC 1NO, 1NC				
C = Momentary flush pushbutton black, label "FORWARD" B = Momentary flush pushbutton black, label "REVERSE" A = Momentary raised pushbutton red, label "STOP"	NEMA 4X Fiberglass	1NO, 1NC 1NO, 1NC 1NO, 1NC	3	<b>52C301X</b>		
C = Momentary flush pushbutton black, label "UP" B = Momentary flush pushbutton black, label "DOWN" A = Momentary raised pushbutton red, label "STOP"	NEMA 4X Fiberglass	1NO, 1NC 1NO, 1NC 1NO, 1NC	3	<b>52C332X</b>		
C = Momentary flush pushbutton black, label "OPEN" B = Momentary flush pushbutton black, label "CLOSE" A = Momentary raised pushbutton red, label "STOP"	NEMA 4X Fiberglass	1NO, 1NC 1NO, 1NC 1NO, 1NC	3	<b>52C333X</b>		
C = Momentary flush pushbutton black, label "HI" B = Momentary flush pushbutton, black label "LOW" A = Momentary raised pushbutton red, label "STOP"	NEMA 4X Fiberglass	1NO, 1NC 1NO, 1NC 1NO, 1NC	3	<b>52C334X</b>		

① NEMA 4X Stainless Steel Enclosure is 304 SS.



# Pushbutton Units and Indicator Lights

## 30mm Water, Oil Tight & Corrosion Resistant - Class 52

Empty enclosures

### Selection and ordering data



Version	Number of command points	Degree of protection	Order No.①	Pack Unit
Standard enclosures come with 2 1/4" leg center for legend spacing. Automotive end plates require 2 1/2" spacing. For more than 2 contact blocks on the right or left, use extra deep enclosure.	1	NEMA Type 12/13	<b>P30EMS01</b>	
	1	NEMA Type 12/13 extra deep	<b>P30EMS01D</b>	
	1	NEMA Type 4/4X stainless steel	<b>P30EMS014</b>	
	1	NEMA Type 4/4X Fiberglass	<b>P30EMS01X</b>	
Mounting hole arrangement  1 thru 4 are in one row 6 holes are 3 down and 2 across 9 holes are 3 down and 3 across 12 holes are 4 down and 3 across 16 holes are 4 down and 4 across	2	NEMA Type 12/13	<b>P30EMS02</b>	
	2	NEMA Type 12/13 extra deep	<b>P30EMS02D</b>	
	2	NEMA Type 4/4X stainless steel	<b>P30EMS024</b>	
	2	NEMA Type 4/4X Fiberglass	<b>P30EMS02X</b>	
	3	NEMA Type 12/13	<b>P30EMS03</b>	
	3	NEMA Type 12/13 extra deep	<b>P30EMS03D</b>	
	3	NEMA Type 4/4X stainless steel	<b>P30EMS034</b>	
	3	NEMA Type 4/4X Fiberglass	<b>P30EMS03X</b>	
	4	NEMA Type 12/13	<b>P30EMS04</b>	
	4	NEMA Type 12/13 extra deep	<b>P30EMS04D</b>	
	4	NEMA Type 4/4X stainless steel	<b>P30EMS044</b>	
	4	NEMA Type 4/4X Fiberglass	<b>P30EMS04X</b>	
	6	NEMA Type 12/13	<b>P30EMS06</b>	
	6	NEMA Type 12/13 extra deep	<b>P30EMS06D</b>	
	6	NEMA Type 4/4X stainless steel	<b>P30EMS064</b>	
	9	NEMA Type 12/13	<b>P30EMS09</b>	
9	NEMA Type 12/13 extra deep	<b>P30EMS09D</b>		
9	NEMA Type 4/4X stainless steel	<b>P30EMS094</b>		
12	NEMA Type 12/13	<b>P30EMS12</b>		
12	NEMA Type 12/13 extra deep	<b>P30EMS12D</b>		
12	NEMA Type 4/4X stainless steel	<b>P30EMS124</b>		
16	NEMA Type 12/13	<b>P30EMS16</b>		
16	NEMA Type 12/13 extra deep	<b>P30EMS16D</b>		
16	NEMA Type 4/4X stainless steel	<b>P30EMS164</b>		

### Order Form

Ordering Information	
<p>Enclosure Hole Arrangement</p>	<p>To order non-standard control stations select catalog numbers from the previous pages, determine the required position in the enclosure and fill in the table below. If a special legend plate is required, specify description in the table. The combined list prices of the components is the list price of the station.</p> <ul style="list-style-type: none"> <li>Select enclosure</li> <li>Vertical or Horizontal. Outline Diagram at left starting at the top left-hand corner. Example: 3 unit vertical outline location No. 1A, 2A and 3A. 3 unit horizontal outline location No. 1A, 1B, and 1C</li> <li>List location No. and applicable catalog numbers in the table below. Use complete catalog numbers where possible</li> </ul>
<p>Order No./Item No. _____</p> <p>Customer _____</p> <p>Enclosure Catalog No. _____</p>	

Location	Operator PB-SEL.-PL	Accessories Key Lock, Boot, Etc,	Legend Plate Legend or Blank	Special Marking

① NEMA 4X Stainless Steel Enclosure is 304 SS.

# Pushbutton Units and Indicator Lights

## 30 mm Heavy Duty, Watertight/Oiltight, Class 52

### Legend plates for Class 51 and 52

#### Design

The 30 mm legend plates are approved for the use with both Class 51 and Class 52 devices. Automotive legend plates require 2 1/2" mounting centers. Plastic legend plates will have white letters engraved.

When ordering custom engraved legend plates, specify the required inscription text.

#### Selection and ordering data

Inscription	Large (1 7/16" x 2")	Automotive <sup>①</sup> (2 7/16" x 2 7/16")	Large Plastic <sup>②</sup> (1 7/16" x 2")	Automotive Plastic <sup>②②</sup> (2 7/16" x 2 7/16")
	Order No.	Order No.	Order No.	Order No.
"Blank (brushed aluminum)"	52NL02	52NA02	—	—
"Blank (red)"	52NL02R	52NA02R	52ND02R	52NE02R
"Blank (Black)"	52NL02B	52NA02B	52ND02B	52NE02B
<b>Inscribed legend plates with large brushed aluminum background</b>				
Close	52NL18	52NA18	—	—
Down	52NL10	52NA10	—	—
Emerg Stop	52NL16	52NA16	—	—
Emerg Stop (red)	52NL16R	52NA16R	—	—
Fast-Slow	52NL33	52NA33	—	—
Forward	52NL05	52NA05	—	—
For-Off-Rev	52NL38	52NA38	—	—
For-Rev	52NL31	52NA31	—	—
Hand-Off-Auto	52NL37	52NA37	—	—
High	52NL07	52NA07	—	—
High-Low	52NL30	52NA30	—	—
High-Off-Low	52NL44	52NA44	—	—
In	52NL21	52NA21	—	—
Jog	52NL13	52NA13	—	—
Jog-Forward	52NL24	52NA24	—	—
Jog-Reverse	52NL25	52NA25	—	—
Low	52NL08	52NA08	—	—
Lower	52NL20	52NA20	—	—
Man-Auto	52NL35	52NA35	—	—
Off	52NL12	52NA12	—	—
Off-On	52NL26	52NA26	—	—
On	52NL11	52NA11	—	—
On-Off-Auto	52NL40	52NA40	—	—
Open	52NL17	52NA17	—	—
Open-Close	52NL34	52NA34	—	—
Open-Off-Close	52NL41	52NA41	—	—
Out	52NL22	52NA22	—	—
Pull to Start Push to Stop	52NL47	52NA47	—	—
Raise	52NL19	52NA19	—	—
Raise-Lower	52NL36	52NA36	—	—
Reset	52NL14	52NA14	—	—
Reverse	52NL06	52NA06	—	—
Run	52NL23	52NA23	—	—
Run-Jog	52NL29	52NA29	—	—
Safe-Run	52NL27	52NA27	—	—
Slow-Off-Fast	52NL39	52NA39	—	—
Start	52NL03	52NA03	—	—
Start-Jog	52NL28	52NA28	—	—
Start-Stop	52NL32	52NA32	—	—
Stop	52NL04	52NA04	—	—
Stop (red)	52NL04R	52NA04R	—	—
Up	52NL09	52NA09	—	—
Up-Down	52NL49	52NA49	—	—
Up-Off-Down	52NL42	52NA42	—	—
<b>Inscription plates with custom engraving</b>				
"Custom engraved (brushed aluminum)"	52NL02E	52NA02E	—	—
"Custom engraved (red)"	52NL02RE	52NA02RE	52ND02RE	52NE02RE
"Custom engraved (Black)"	52NL02BE	52NA02BE	52ND02BE	52NE02BE
Max. number of rows	2	2	2	2
Letter height	5/32"	1/4"	5/32"	1/4"
Characters per row	14	16	14	16

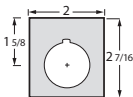
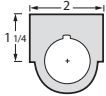

① Automotive requires 2 1/2" mounting centers  
② White letters on plastic nameplate.

# Pushbutton Units and Indicator Lights

## 30mm Heavy Duty, Watertight/Oiltight, Class 52

### Dimensional drawings

1  
2  
3  
4  
5  
6  
7  
8  
9  
10

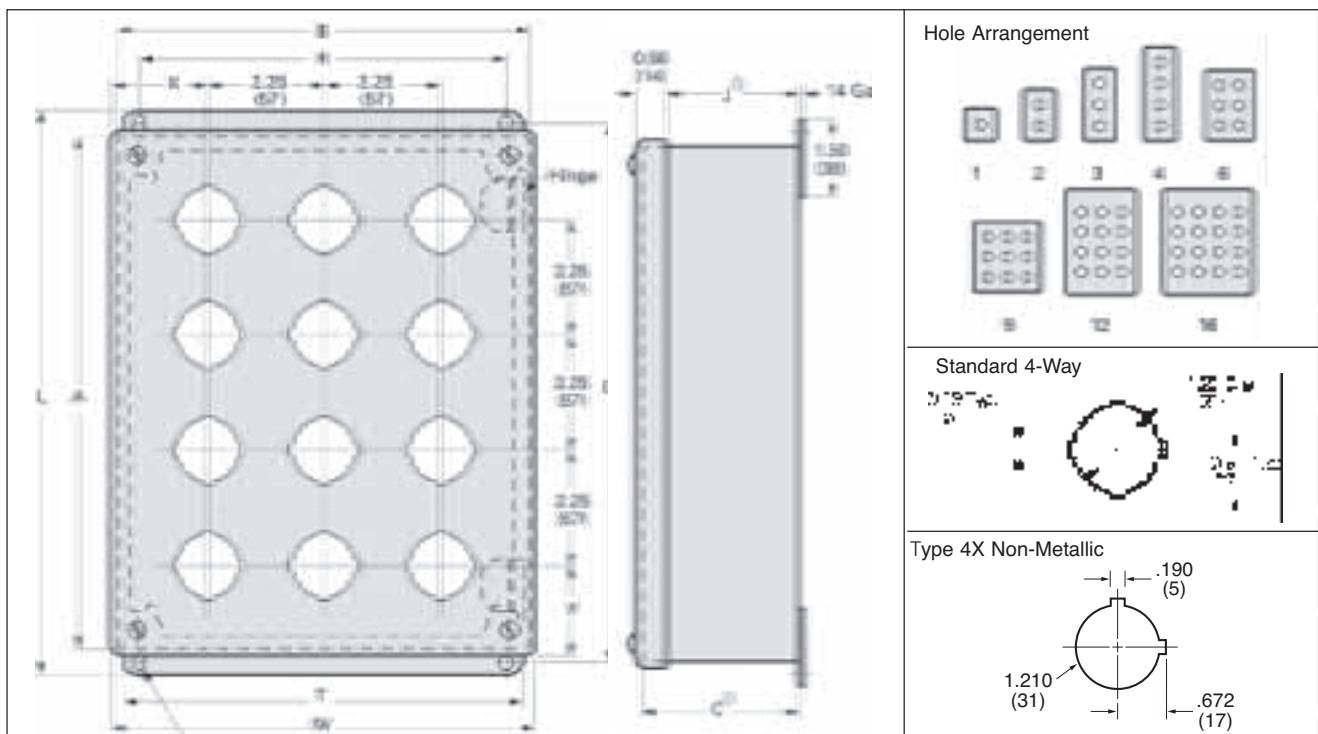

#### Type 12/13 and 4X Stainless Steel

Units	Enclosure Size			Mounting		Overall					
	A	B	C	G	H	L	W	J	T	X	Y
1	3.50 (89)	3.25 (83)	2.75 (70)	4.00 (102)	2.38 (60)	4.50 (114)	3.47 (88)	2.31 (59)	3.00 (76)	1.73 (44)	1.86 (47)
2	5.75 (146)	3.25 (83)	2.75 (70)	6.25 (159)	2.38 (60)	6.75 (171)	3.47 (88)	2.31 (59)	3.00 (76)	1.73 (44)	1.86 (47)
3	8.00 (203)	3.25 (83)	2.75 (70)	8.50 (216)	2.38 (60)	9.00 (229)	3.47 (88)	2.31 (59)	3.00 (76)	1.73 (44)	1.86 (47)
4	10.25 (260)	3.25 (83)	2.75 (70)	10.75 (273)	2.38 (60)	11.25 (286)	3.47 (88)	2.31 (59)	3.00 (76)	1.73 (44)	1.86 (47)
6	9.50 (241)	6.25 (159)	3.00 (76)	10.00 (254)	5.38 (137)	10.50 (267)	6.47 (164)	2.56 (65)	6.00 (152)	2.11 (54)	2.61 (66)
9	9.50 (241)	8.50 (216)	3.00 (76)	10.00 (254)	7.62 (194)	10.50 (267)	8.72 (221)	2.56 (65)	8.25 (210)	2.11 (54)	2.61 (66)
12	11.75 (298)	8.50 (216)	3.00 (76)	12.25 (311)	7.62 (194)	12.75 (324)	8.72 (221)	2.56 (65)	8.25 (210)	2.11 (54)	2.61 (66)
16 <sup>2)</sup>	11.75 (298)	10.75 (273)	3.00 (76)	12.25 (311)	9.88 (251)	12.75 (324)	10.97 (279)	2.56 (65) <sup>2)</sup>	10.50 (267)	2.11 (54)	2.61 (66)

#### Type 12/13 Extra Deep Enclosures

Units	Enclosure Size			Mounting		Overall					
	A	B	C	G	H	L	W	J	T	X	Y
1	4.00	4.00	4.75	4.50	3.12	5.00	4.22	4.31	3.75	2.11	2.11
2	6.00	4.00	4.75	6.50	3.12	7.00	4.22	4.31	3.75	2.11	1.98
3	8.00	4.00	4.75	8.50	3.12	9.00	4.22	4.31	3.75	2.11	1.86
4	10.00	4.00	4.75	10.50	3.12	11.00	4.22	4.31	3.75	2.11	1.73
6	9.50	6.25	4.75	10.00	5.38	10.50	6.47	4.31	6.00	2.11	2.61
9	9.50	8.50	4.75	10.00	7.62	10.50	8.72	4.31	8.25	2.11	2.61
12	11.75	8.50	4.75	12.25	7.62	12.75	8.72	4.31	8.25	2.11	2.61
16 <sup>2)</sup>	11.75	10.75	4.75	12.25	9.88	12.75	10.97	4.31	10.50	2.11	2.61

#### Type 4X Non-Metallic

Units	Enclosure Size			Mounting		Overall	
	A	B	C	G	H	L	W
1	6.00	3.19	3.63	4.88	2.94	6.63	3.81
2	6.00	3.19	3.63	4.88	2.94	6.63	3.81
3	8.26	3.19	3.63	7.13	2.94	8.88	3.81
4	10.51	3.19	3.63	9.37	2.94	11.13	3.81

All dimensions shown in inches and (millimeters). For reference purposes only. Not to be used for design or construction purposes.

- 1) Grounding stud in body of enclosure.
- 2) For stainless steel add 1.75 (45) to depth.

# Pushbutton Units and Indicator Lights

## 30 mm Pilot Devices

• Revised •  
08/15/14

### Technical Specifications

<b>Standards</b>	UL Listed File # E22655	CSA Certified File # LR6535
<b>Utilization</b>	Category NEMA	A600/P600
<b>Degree of Protection</b>	52B, 52P-, 52S-, 52M- Operators	NEMA: 1, 3, 3R, 4, 4X, 12 and 13 IEC 529; IP10, IP11, IP14, IP52, IP54, IP56 and IP66

### Rated Operational Current

NEMA A600 – 10 Continuous Amps			NEMA P600 – Rating Codes for DC Control Circuit Application	
Voltage AC	Make Amps	Break Amps	Thermal Continuous Test Current Amps	
120V	<b>60</b>	<b>6</b>	<b>Maximum Make or Break; Current / Amps</b>	5.0
240V	<b>30</b>	<b>3</b>	125V	1.10
480V	<b>15</b>	<b>1.5</b>	250V	0.55
600V	<b>12</b>	<b>1.2</b>	301-600V	0.20
Total VA	<b>7200</b>	<b>720</b>	<b>Maximum Make or Break Volt amperes at 300V or Less</b>	138

<b>Contact Blocks</b>	52BAK, -BAJ <sup>Ⓞ</sup> , -BAH, -BAU, -BJK <sup>Ⓞ</sup> 52BAR	600VAC Maximum, Heavy Duty 200VAC .25 Amp, 10 Watt Maximum 200VDC .50 Amp, 10 Watt Maximum
-----------------------	---	--

<sup>Ⓞ</sup>  Positively driven contacts. Contact blocks are suitable for applications down to 5V/1MA low voltage applications as found in PLCs. 52BAR are Class 1; Division 2 Compliant

Pilot Light	Full Voltage	LED Module	Transformer Type	52PL4/52PL5 or 52BL4/52BL5	-B (6-8V), -C (12V), -D (24V), -E (120V), -F (240V) -L (24V), -M (120V) -N (240V) -G (120V), -H (240V), -J (480V), -K (600V)	240V AC/DC Max. 240V AC Max. 600V AC Max., 50/60 Hz
<b>Push-to-Test</b>	Full Voltage	LED Module	Transformer Type	52PT6 or 52BT6	-B (6-8V), -C (12V), -D (24V), -E (120V), -F (240V) -L (24V), -M (120V), -N (240V) -G (120V), -H (240V), -J (480V), -K (600V)	240V AC/DC Max. 240V AC Max. 600VAC Max., 50/60 Hz
<b>Illuminated Push-Pull</b>	Full Voltage	LED Module	Transformer	52PP2(3,7) or 52BP2(3,7)	-B (6-8V), -C (12V), -D (24V), -E (120V), -F (240V) -L (24V), -M (120V), -N (240V) -G (120V), -H (240V), -J (480V), -K (600V)	240V AC/DC Max. 240V AC Max. 600VAC Max., 50/60 Hz
<b>Twist-to-Release</b>	Full Voltage	LED Module	Transformer	52BR8 or 52PR8	-B (6-8V), -C (12V), -D (24V), -E (120V), -F (240V) -L (24V), -M (120V), -N (240V) -G (120V), -H (240V), -J (480V), -K (600V)	240V AC/DC Max. 240V AC Max. 600VAC Max., 50/60 Hz
<b>Illuminated Selector Switch</b>	Full Voltage	Transformer		52SA7(A,B,C) or 52SX7(A,B,C)	-B (6-8V), -C (12V), -D (24V), -E (120V), -F (240V) -G (120V), -H (240V), -J (480V), -K (600V)	240V AC/DC Max. 600V AC Max., 50/60 Hz

**Dielectric Strength** 2200V for one minute

### Mechanical Design Life Cycles

<b>Vibration</b>	Frequency 5 - 60Hz.; Disp. .030 inches, sweep 5 minutes for a duration of 30 minutes on each axis. Not to exceed 5.5 G's for maximum of 1 minute.	
<b>Pushbuttons</b>	Momentary, Non-illuminated	5,000,000 Operating Cycles
	Momentary, Illuminated	300,000 Operating Cycles
<b>Push-Pull</b>	Maintained	300,000 Operating Cycles
	Momentary	2,000,000 Operating Cycles
<b>Twist-to-Release</b>		300,000 Operating Cycles
<b>Selector Switches</b>	Non-illuminated	2,000,000 Operating Cycles
	Illuminated, Key-operated	2,000,000 Operating Cycles
<b>Contact Operation</b>	Standard Contact Black Logic Reed	
<b>Wire Gauge</b>	#18-12 AWG	
<b>Terminal Screw Torque</b>	2-10 lb-in / 20 lb-in max; 8 lb-in recommended	
<b>Locknut Torque</b>	15 ft. lbs. max	
<b>Temperature Range</b>	Operating	31F to +158F (-35C to +70C)
	Storage	40F to +185F (-40C to +85C)

All parts are designed and manufactured of corrosion resistant material or are plated or painted as corrosion protection. All contact block contacts are gold flashed as a standard offering. Internal return spring mechanisms of operators and contact blocks of stainless steel. RoHS Compliant.

**Declaration of Conformity** — The products listed below, to which this declaration relates, are in conformity with the following standards, following the provisions of the Low Voltage Directive (LVD) (73/23/EEC), and the Electromagnetic Compatibility Directive (89/336/EEC.)

**Products:** Contact Blocks: Cat Nos. 52BAE, 52BAH, 52BAJ, 52BAK, 52BAR, 52BAU and 52BJK, with suffixes. Pilot Lights: Cat Nos 52P, with suffixes. Operators: Cat Nos 52S or 52P, with suffixes.

**Applicable Standards:** EN 60947-5-1 Low-Voltage Switchgear and controlgear. Enclosed devices meet the requirements of environmental ratings of IP10, IP11, IP14, IP52, IP54, and IP56. Open devices, when mounted as instructed, in environmental type IP10, IP11, IP14, IP52, IP54 or IP56 enclosures, maintain the environmental requirements for those enclosure types. Cat. No. 52BP, 52BR, 52PP, and 52PR, 2 Position, Twist-To-Release and 2 Position, Push Pull Maintained operators provided with red operating heads and 52BJK contact blocks meet the requirements of EN 60947-5-5 for Electrical Emergency Stop Device With Mechanical Latching Function (e-stop).