

Switches & Motor Controls

A

- Toggle Switches A-2
- Traditional Switches A-2
- CO/ALR Switches A-3
- Lev-Lok® Modular Switches A-14
- Decora® Switches A-16
- Appliance Switches A-23
- Anywhere RF Remote Switches A-25
- Manual Motor Starter Switches A-26
- Safety Disconnect Switches A-30
- Switched Enclosures A-34

PowerSwitch™ BY **LEVITON®**
SAFETY DISCONNECT SWITCH
 30 AMP 600 VOLT AC MAX.
 CATALOG NUMBER: DS30-AX
 TYPE : 3R, 4X, 12K
 IP67

WARNING
 THIS SWITCH
 DOES NOT PROVIDE
 OVERCURRENT PROTECTION
AVERTISSEMENT
 CET INTERRUPTEUR N'ASSURE
 AUCUNE PROTECTION CONTRE
 LES SURINTENSITÉS
ADVERTENCIA
 ESTE INTERRUPTOR NO DA
 PROTECCIÓN DE
 SOBRETENSION

OFF
 TURN OFF BEFORE OPENING ENCLOSURE
 ATTRE L'INTERRUPTEUR EN POSITION ARRÊT AVANT D'OUVRIR
 LA BOÎTE
 ARC FLASH AND SHOCK HAZARD - MAY BE REQUIRED TO DE-ENERGIZE
 ARC ELECTRIQUE ET RISQUE DE
 INTERRUPTEUR GENERAL PELIGRO
 TENSION AVANT L'ENTRÉE
 EN CONTACT AVEC LES PARTIES
 ÉLECTRIQUES
 DESCOMPONER ANTES DE
 ABRIR LA CAJA
 PELIGRO DE
 DESCARGA ELÉCTRICA Y PELIGRO
 DE
 CONTACTO CON PARTES
 ELÉCTRICAS
 DESMONTAR ANTES DE
 ABRIR LA CAJA
 PELIGRO DE
 DESCARGA ELÉCTRICA Y PELIGRO
 DE
 CONTACTO CON PARTES
 ELÉCTRICAS

TOGGLE | Traditional AC Quiet

Toggle Switches

Traditional

AC Quiet Toggle Switches

Tried-and-true toggle designs, Leviton residential grade AC Quiet switches cover all the bases; they install easily and are available in standard and illuminated versions. Their toggles and frames are constructed from impact-resistant thermoplastic, and they feature large head, hardened triple-drive screws for easy installation. Leviton's traditional switches are compatible with a wide range of Leviton plastic and metal wallplates.

Sample Toggle Switches

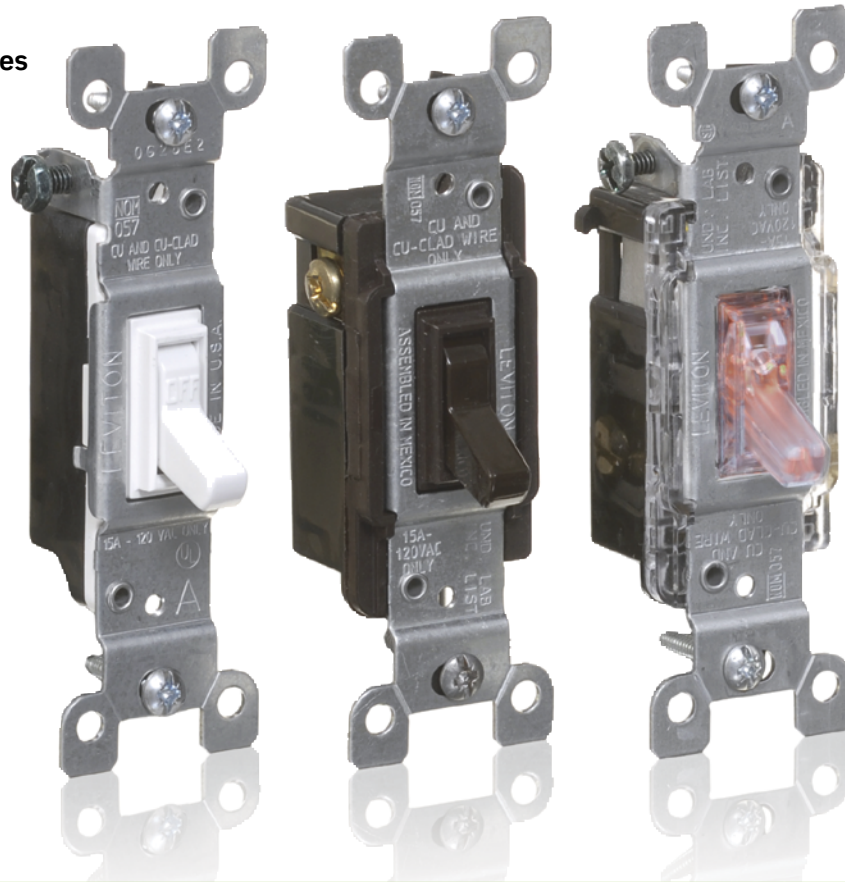

Color Choices Toggle switches are offered in a wide range of colors. To order colors, add suffix to Cat. No.



White
(-W)



Ivory
(-I)



Light Almond
(-T)



Black
(-E)



Brown

Features and Benefits

- Faster installation with combination of side wiring and Quickwire push-in wiring
- Terminal screws accept up to #12 AWG copper or copper-clad wire
- Quickwire push-in terminals accept #14 AWG solid copper wire only
- Large head, hardened triple-drive combination screws (Standard, Phillips, or Robertson) for fast wiring installation
- Impact-resistant, durable thermoplastic toggle and frame
- Limited 2-year warranty



AC Quiet Quickwire Push-In and Side Wired  				
Rating		15A-120V AC Non-grounded	15A-120V AC w/ground screw	15A-120V AC Self-grounded Backwired Clamp
Description	Color	Cat. No.	Cat. No.	Cat. No.
Single Pole	White	1451-W	1451-2W	RS115-W
	Ivory	1451-I	1451-2I	RS115-I
	Light Almond	—	1451-2T	RS115-T
	Black	—	1451-2E	RS115-2E
	Brown	1451	1451-2	RS115-2
3-Way	White	1453-W	1453-2W	—
	Ivory	1453-I	1453-2I	—
	Light Almond	—	1453-2T	—
	Black	—	1453-2E	—
	Brown	1453	1453-2	—
4-Way	White	—	54504-2W	—
	Ivory	—	54504-2I	—
	Light Almond	—	54504-2T	—
	Black	—	54504-2E	—
	Brown	—	54504-2	—



1451-2I





1461-LHC

AC Quiet Quickwire and Side Wired — Illuminated  			
Rating			15A-120V AC w/ground screw
Description	Toggle Color	Illumination	Cat. No.
Single Pole	Clear	Amber	1461-LHC
3-Way	Clear	Amber	1463-LHC

CO/ALR Switches

Features and Benefits

- Designed specifically to work with aluminum conductors
- Faster installation with combination of side wiring and Quickwire push-in wiring
- Side wire accepts conductors up to #12 AWG
- Quickwire accepts conductors up to #12 AWG; #14 AWG in Canada
- Large head, hardened triple-drive combination screws (standard, Phillips or Robertson) for fast wiring installation
- Impact-resistant, durable thermoplastic toggle and frame
- Limited 2-year warranty

CO/ALR Side Wired Switches — Framed  		
Rating		15A-120V AC w/ground screw
Description	Color	Cat. No.
Single Pole	White	2651-2W
	Ivory	2651-2I
3-Way	White	2653-2W
	Ivory	2653-2I

Note: CO/ALR devices are for connection to #12 or #10 AWG Aluminum Conductors



2651-2I

TOGGLE | Traditional AC Quiet

AC-Quiet Commercial Specification Grade Switches

Leviton's commercial specification grade switches are designed to offer outstanding reliability and top performance in commercial settings. Ideal applications include municipal facilities, government buildings, malls, department stores, hospital and health care facilities, office buildings, schools, colleges, universities, houses of worship and cultural institutions. Leviton offers a large selection of 15 and 20 Amp commercial switches in a wide variety of colors, wiring options and other features.

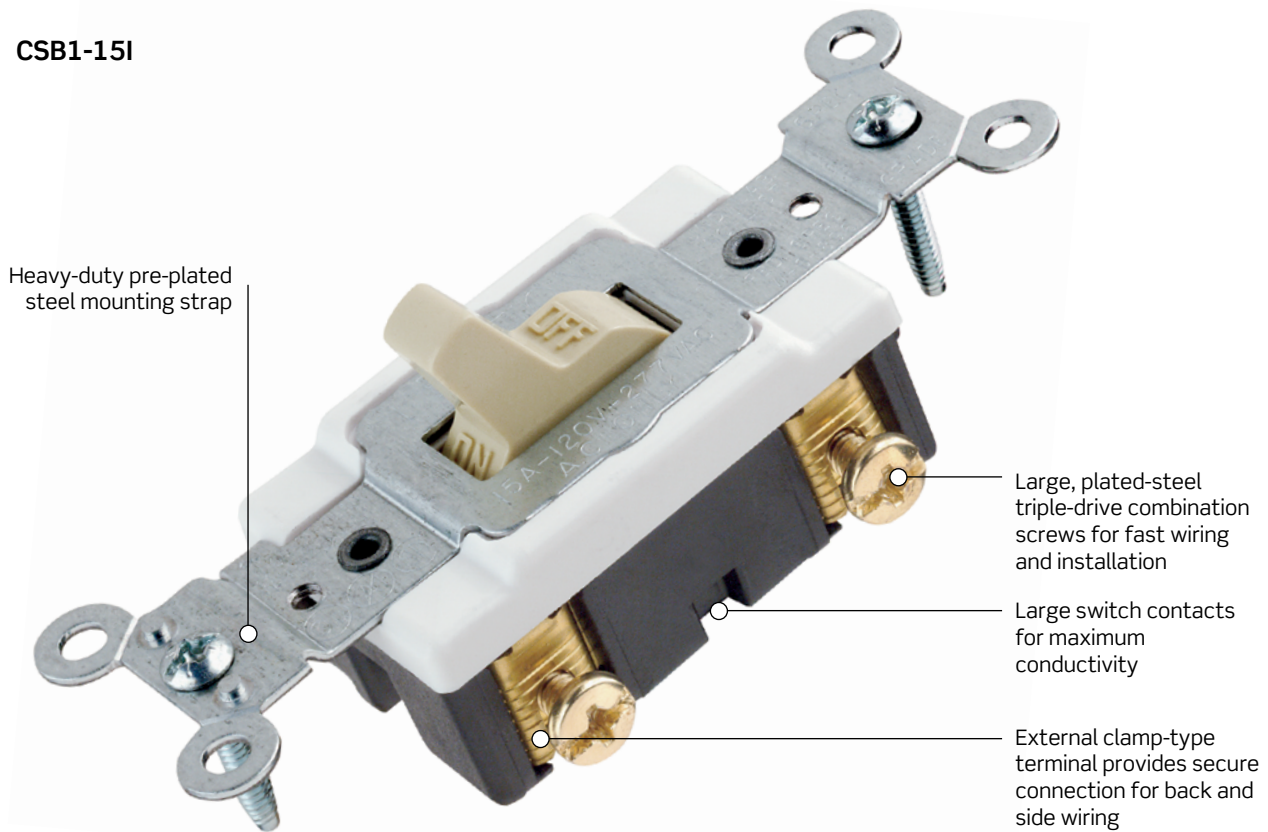
CSB1-15I

Color Choices AC Quiet toggle switches are offered in a wide range of colors. To order colors, add suffix to Cat. No.

Features and Benefits

- Listed UL Federal Specification WS896
- Heavy-duty pre-plated steel mounting strap for maximum strength
- All screws are plated-steel combination-head for fast installation with standard, Phillips and Robertson head screwdrivers
- External clamp-type wiring terminals provides secure connection of solid or stranded wire for back or side wiring (CSB1 and CSB3)
- Backed by a limited 10-year warranty

TOGGLE | AC Quiet Commercial Specification Grade

AC Quiet Back and Side Wired FED SPEC			
Rating		15A-120/277V AC	20A-120/277V AC
Description	Color	Cat. No.	Cat. No.
Single Pole	White	CSB1-15W	CSB1-20W
	Ivory	CSB1-15I	CSB1-20I
	Light Almond	CSB1-15T	CSB1-20T
	Gray	CSB1-15G	CSB1-20G
	Brown	CSB1-15	CSB1-20
Double Pole	White	CSB2-15W	CSB2-20W
	Ivory	CSB2-15I	CSB2-20I
	Light Almond	CSB2-15T	CSB2-20T
	Gray	—	CSB2-20G
	Brown	CSB2-15	CSB2-20
3-Way	White	CSB3-15W	CSB3-20W
	Ivory	CSB3-15I	CSB3-20I
	Light Almond	CSB3-15T	CSB3-20T
	Gray	—	CSB3-20G
	Brown	CSB3-15	CSB3-20
4-Way	White	CSB4-15W	CSB4-20W
	Ivory	CSB4-15I	CSB4-20I
	Light Almond	CSB4-15T	CSB4-20T
	Brown	CSB4-15	CSB4-20
	Gray	—	CSB4-20G

Note: Cat. Nos. CSB1 and CSB3 feature external clamp-type wiring termination for back and side wiring



CSB1-20



CSB3-20G

AC Quiet Side Wired FED SPEC			
Rating		15A-120/277V AC	20A-120/277V AC
Description	Color	Cat. No.	Cat. No.
Single Pole	White	CS115-2W	CS120-2W
	Ivory	CS115-2I	CS120-2I
	Light Almond	CS115-2T	CS120-2T
	Gray	CS115-2GY	CS120-2GY
	Black	CS115-2E	CS120-2E
	Brown	CS115-2	CS120-2
Single Pole	Ivory	5501-8I	—
Hospital Call Switch*	Brown	5501-8	—
Single Pole, Framed Toggle	White	54501-2W	54521-2W
	Ivory	54501-2I	54521-2I
	Gray	54501-2GY	54521-2GY
	Brown	54501-2	54521-2
Double Pole	White	CS215-2W	CS220-2W
	Ivory	CS215-2I	CS220-2I
	Light Almond	—	CS220-2T
	Gray	CS215-2GY	CS220-2GY
	Black	—	CS220-2E
	Brown	CS215-2	CS220-2
Double Pole	Brown	5502-8	—
Hospital Call Switch*			
Double Pole, Framed Toggle	White	54502-2W	54522-2W
	Ivory	54502-2I	54522-2I
	Brown	54502-2	54522-2



CS120-2W



5501-8

*Hospital Call Switch turns on when toggle is pulled down with cord (3-ft braided cord included)

Continued on next page

TOGGLE | Traditional AC Quiet Spec Grade

Continued from previous page

AC-Quiet Commercial Specification Grade Switches

AC Quiet Side Wired   FED SPEC			
Rating		15A-120/277V AC	20A-120/277V AC
Description	Color	Cat. No.	Cat. No.
3-Way	White	CS315-2W	CS320-2W
	Ivory	CS315-2I	CS320-2I
	Light Almond	CS315-2T	CS320-2T
	Gray	CS315-2GY	CS320-2GY
	Black	—	CS320-2E
	Brown	CS315-2	CS320-2
3-Way, Framed Toggle	White	54503-2W	54523-2W
	Ivory	54503-2I	54523-2I
	Gray	54503-2GY	54523-2GY
	Brown	54503-2	54523-2
4-Way	White	CS415-2W	CS420-2W
	Ivory	CS415-2I	CS420-2I
	Light Almond	CS415-2T	CS420-2T
	Gray	CS415-2GY	CS420-2GY
	Black	—	CS420-2E
	Brown	CS415-2	CS420-2
4-Way, Framed Toggle	White	54504-2W	54524-2W
	Ivory	54504-2I	54524-2I
	Light Almond	54504-2T	—
	Gray	54504-2GY	54524-2GY
	Brown	54504-2	54524-2

AC Quiet Side Wired — Lighted   FED SPEC		
Rating		15A-120V AC
Description	Color	Cat. No.
Single Pole	White	5501-LHW
	Ivory	5501-LHI
3-Way	White	5503-LHW
	Ivory	5503-LHI



CS320-2



5501-LHW

TOGGLE | Traditional Spec Grade and Locking

AC Quiet Side Wired — Canadian				
Rating		15A-120/277V AC	20A-120/277V AC	15A-347V AC
Description	Color	Cat. No.	Cat. No.	
Single Pole, Framed Toggle	White	1101-CW	—	18201-CW
	Ivory	1101-CI	54521-I	18201-CI
	Gray	1101-CG	—	18201-CG
	Black	1101-CE	—	—
	Brown	1101-CB	54521-B	18201-CB
Double Pole, Framed Toggle	White	1102-CW	54522-W	18202-CW
	Ivory	1102-CI	54522-I	18202-CI
	Brown	1102-CB	54522-B	18202-CB
3-Way, Framed Toggle	White	1103-CW	54523-W	18203-CW
	Ivory	1103-CI	54523-I	18203-CI
	Gray	1103-CG	—	18203-CG
	Brown	1103-CB	54523-B	18203-CB
4-Way, Framed Toggle	White	1104-CW	—	18204-CW
	Ivory	1104-CI	—	18204-CI
	Gray	—	—	18204-CG
	Black	1104-CE	—	—
	Brown	1104-CB	54524-B	18204-CB



1101-CG

TOGGLE | Traditional Spec Grade and Locking**Extra Heavy-Duty Specification Grade Toggle and Locking Switches**

Leviton's Industrial Grade AC toggle switches for extra heavy-duty applications represent top-of-the-line quality and peak performance. Leviton uses the finest materials available and the highest production standards to produce industrial switches of unmatched versatility and reliability.

Features and Benefits

- Heavy gauge copper alloy brush arm for superior performance
- Large silver alloy contacts for long life prevent sticking, welding and excessive pitting
- Color-coded covers: 15 Amp — Blue; 20 Amp — Red; 30 Amp — Green, for easy identification
- Fully enclosed switch mechanism in rugged housing for strength, tracking and arc resistance
- Self-grounding clip (self grounding when used with a grounded metal wallbox)
- Wire lead switches also available for fast and easy installation
- Backed by a limited 10-year warranty

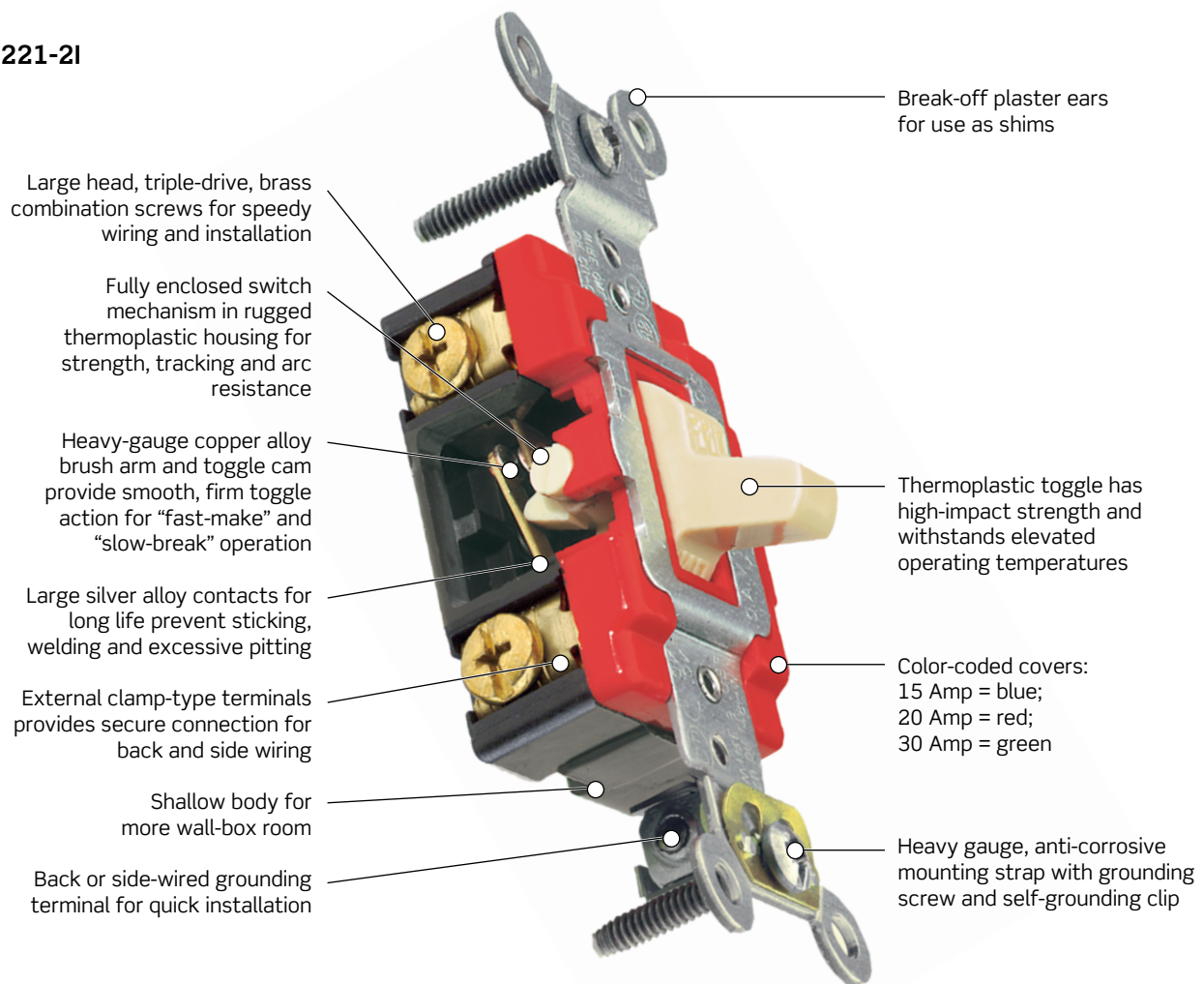
1221-2I

Color Choices Extra heavy-duty toggle switches are offered in a wide range of colors. To order colors, add suffix to Cat. No.

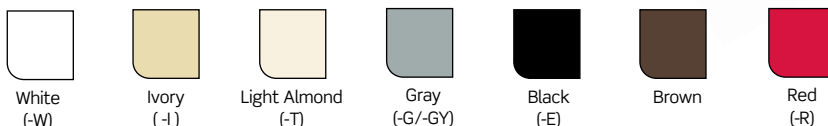

TOGGLE | Extra Heavy-Duty Spec Grade and Locking

Back and Side Wired/Wire Lead Toggle Switches FED SPEC				
Rating		15A-120/277V AC	20A-120/277V AC	30A-120/277V AC
Description	Color	Cat. No.	Cat. No.	Cat. No.
Single Pole	White	1201-2W	1221-2W	3031-2W
	Ivory	1201-2I	1221-2I	3031-2I
	Light Almond	—	1221-2T	—
	Gray	1201-2GY	1221-2GY	—
	Black	—	1221-2E	—
	Brown	1201-2	1221-2	3031-2
	Red	1201-2R	1221-2R	—
Single Pole, Tamper Resistant [†]	White	—	1221-2WL	—
	Ivory	1201-2IL	1221-2IL	—
	Gray	—	1221-2GL	—
	Brown	1201-2L	1221-2L	3031-2L
Single Pole, with 6" Wire Leads	White	—	1221-2RL	—
	Ivory	1241-W	1243-W	—
	Gray	1241-LGY	1243-LGY	—
Double Pole	White	1202-2W	1222-2W	3032-2W
	Ivory	1202-2I	1222-2I	3032-2I
	Gray	1202-2GY	1222-2GY	—
	Black	—	1222-2E	3032-2E
	Brown	1202-2	1222-2	3032-2
	Red	—	1222-2R	3032-2R
Double Pole, Tamper Resistant [†]	Ivory	—	1222-2IL	—
	Brown	1202-2L	1222-2L	3032-2L
3-Way	White	1203-2W	1223-2W	3033-2W
	Ivory	1203-2I	1223-2I	3033-2I
	Light Almond	—	1223-2T	—
	Gray	1203-2GY	1223-2GY	—
	Black	—	1223-2E	—
	Brown	1203-2	1223-2	3033-2
	Red	1203-2R	1223-2R	—
3-Way, Tamper Resistant [†]	White	—	1223-2WL	—
	Ivory	1203-2IL	1223-2IL	—
	Gray	—	1223-2GL	—
	Brown	1203-2L	1223-2L	3033-2L
3-Way, with 6" Wire Leads	White	1242-W	1244-W	—
	Ivory	1242-I	1244-I	—
	Gray	—	1244-LGY	—
4-Way	White	1204-2W	1224-2W	—
	Ivory	1204-2I	1224-2I	—
	Light Almond	—	1224-2T	—
	Gray	1204-2GY	1224-2GY	—
	Black	—	1224-2E	—
	Brown	1204-2	1224-2	—
	Red	—	1224-2R	—
4-Way, Tamper Resistant [†]	White	—	1224-2WL	—
	Ivory	—	1224-2IL	—
	Gray	—	1224-2GL	—
	Brown	1204-2L	1224-2L	—
*Key for Tamper Resistant Switch		55500-PRT		

Note: Cat. Nos. 1201, 1202, 1203, 1221, 1222, and 1223 feature external clamp-type wiring termination for back and side wiring



1201-2IL



1221-2I



3031-2W

TOGGLE | Traditional Spec Grade and Locking

Extra Heavy-Duty Specification Grade Toggle and Locking Switches

Back and Side Wired Toggle Switches FED SPEC		
Rating	20A-120/277V AC	
Description	Color	Cat. No.
Single Pole	White	1221-SW
	Ivory	1221-SI
	Light Almond	1221-ST
	Gray	1221-SGY
	Brown	1221-S
	Red	1221-SR
Double Pole	White	1222-SW
	Ivory	1222-SI
	Gray	1222-SGY
	Brown	1222-S
3-Way	White	1223-SW
	Ivory	1223-SI
	Light Almond	1223-ST
	Gray	1223-SGY
	Brown	1223-S
	Red	1223-SR
4-Way	White	1224-SW
	Ivory	1224-SI
	Gray	1224-SGY
	Brown	1224-S

Note: Cat. Nos. 1221, 1222, and 1223 feature external clamp-type wiring termination for back and side wiring

Back and Side Wired Toggle Switches — Canadian			
Rating		15A-347V AC/CA	20A-347V AC/CA
Description	Color	Cat. No.	Cat. No.
Single Pole	White	18201-W	18221-W
	Ivory	18201-I	18221-I
	Gray	18201-G	18221-G
	Brown	18201-B	18221-B
	Red	18201-R	18221-R
Single Pole, Tamper Resistant* (locking)	Brown	18201-LB	18821-LB
Double Pole	Ivory	18202-I	18222-I
	Brown	—	18222-B
Double Pole, Tamper Resistant* (locking)	Brown	18202-LB	18222-LB
3-Way	White	18203-W	18223-W
	Ivory	18203-I	18223-I
	Gray	18203-G	18223-G
	Brown	18203-B	18223-B
	Red	18203-R	18223-R
3-Way, Tamper Resistant* (locking)	Brown	18203-LB	18223-LB
4-Way	White	—	18224-W
	Ivory	18204-I	18224-I
	Gray	18204-G	—
	Brown	18204-B	18224-B
	Red	18204-R	—

*Key for Tamper Resistant Switch 55500-PRT

Note: Cat. Nos. 18201, 18202, 18203, 18221, 18222, and 18223 feature external clamp-type wiring termination for back and side wiring.
Note: 15A — White covers and .042 thick strap



1221-SW



18201-R



55500-PRT

Maintained and Momentary Contact Extra Heavy-Duty Specification Grade

Features and Benefits

- Positive switching action with center-off position
- Large silver cadmium-oxide contacts for long life prevent sticking, welding and excessive pitting
- Clamp-type terminals accept up to #10 CU wire
- Full rated current capacity on fluorescent, tungsten and resistive loads; motor load capacity up to 80% switch current rating
- Backed by a limited 10-year warranty

Back and Side Wired — Maintained Contact Toggle Switches

Rating		15A-120/277V AC	20A-120/277V AC	30A-120/277V AC
Description	Color	Cat. No.	Cat. No.	Cat. No.
Single Pole, Double Throw, Center Off	White	1281-W	1285-W	—
	Ivory	1281-I	1285-I	1287-I
	Lt. Almond	—	1285-T	—
	Gray	—	1285-GY	—
	Brown	1281	1285	1287
	Red	—	1285-R	—
Single Pole, Double Throw, Center Off, Tamper Resistant† (locking)	Black	1281-L	1285-L	1287-L
Double Pole, Double Throw, Center Off	White	1282-W	1286-W	1288-W
	Ivory	1282-I	1286-I	1288-I
	Brown	1282	1286	1288
Double Pole, Double Throw, Center Off, Tamper Resistant† (locking)	Black	—	—	1288-L
*Key for Tamper Resistant Switch		55500-PRT		



1281-L



1288

Back and Side Wired — Momentary Contact Toggle Switches

Rating		15A-120/277V AC	20A-120/277V AC	30A-120/277V AC
Description	Color	Cat. No.	Cat. No.	Cat. No.
Single Pole, Double Throw, Center Off	White	1256-W	1257-W	—
	Ivory	1256-I	1257-I	—
	Light Almond	—	1257-T	—
	Gray	1256-GY	1257-GY	—
	Brown	1256	1257	1260
	Red	—	1257-R	—
Single Pole, Double Throw, Center Off, Tamper Resistant† (locking)	Black	—	1257-L	—
Double Pole, Double Throw, Center Off	Brown	—	—	1262
*Key for Tamper Resistant Switch		55500-PRT		



1257-L

TOGGLE | Traditional Pilot Light and Lighted Handle**Pilot Light and Lighted Handle Extra Heavy-Duty Specification Grade****Features and Benefits**

- Pilot light and lighted handle switches provide top performance in punishing industrial applications
- Lighted handle illuminated when load is OFF. Pilot light toggle illuminated when load is ON
- 120 and 277V versions in single pole and 3-way
- Fully enclosed switch mechanism in rugged housing for strength, track and arc resistance
- Self-grounding clip (self grounding when used with a grounded metal wallbox)
- Backed by a limited 10-year warranty

Back and Side Wired Toggle Switches — Pilot Light   **FED SPEC**

Rating		15A-120V AC	20A-120V AC	20A-277V AC	30A-120V AC
Description	Color	Cat. No.	Cat. No.	Cat. No.	Cat. No.
Single Pole	Clear	1201-PLC	1221-PLC	1221-7PC	3031-PLC
	Red	1201-PLR	1221-PLR	1221-7PR	3031-PLR
	Green	1201-PLG	1221-PLG	—	—
Double Pole	Clear	—	1222-PLC	—	3032-PLC
	Red	1202-PLR	1222-PLR	1222-7PR	3032-PLR
	Green	—	1222-PLG	—	—
3-Way	Clear	1203-PLC	1223-PLC	—	—
	Red	1203-PLR	1223-PLR	1223-7PR	—
	Green	1203-PLG	1223-PLG	—	—



1201-PLC

Back and Side Wired Toggle Switches — Lighted Handle   **FED SPEC**

Rating		15A-120V AC	20A-120V AC	20A-277V AC	30A-120V AC
Description	Color	Cat. No.	Cat. No.	Cat. No.	Cat. No.
Single Pole	Clear	1201-LHC	1221-LHC	1221-7LC	—
	White	1201-LHW	1221-LHW	1221-7LW	—
	Ivory	1201-LHI	1221-LHI	1221-7LI	3031-LHI
	Red	—	1221-LHR	—	—
3-Way	Clear	1203-LHC	1223-LHC	1223-7LC	—
	White	1203-LHW	1223-LHW	1223-7LW	—
	Ivory	1203-LHI	1223-LHI	1223-7LI	—
	Red	—	1223-LHR	—	—



1222-PLR



1223-LHW

Extra Heavy-Duty Specification Grade Key Locking Switches

Features and Benefits

- Heavy-Duty key-operated locking mechanism for maximum tamper-proof operation in schools, institutions, public housing, trailer parks, loading docks, freight yards and other areas
- Chrome lock dome with 2 keys provided per switch
- Large, combination head terminal screws with external clamps
- Triple-combination mounting screws for fast, easy installation
- Heavy-gauge rust-resistant mounting strap with steel grounding screw and self-grounding clip (self grounding when used in a properly grounded metal wallbox)
- Key removable in ON and OFF positions
- Backed by a limited 10-year warranty

Key Locking Switches

Rating	20A-120/277V AC	
Description	Color	Cat. No.
Single-Pole Key Lock Power Switch, 2 keys provided	Chrome	1221-2KL
Double-Pole Key Lock Power Switch, 2 keys provided	Chrome	1222-2KL
3-Way Key Lock Power Switch, 2 keys provided	Chrome	1223-2KL
4-Way Key Lock Power Switch, 2 keys provided	Chrome	1224-2KL
Replacement Keys, 2 per pack	—	2KL

Note: Key Lock Power Switches are not recommended for use on Master or Emergency Power Systems



FD/Deep Wallbox

Wallplates and Wallboxes

Description	Cat. No.
302 Stainless Steel comes with tamper-resistant screws and spanner tool	
FD or deep wallbox recommended minimum internal depth	
2 3/4" single cover/gang adapter extends shallow wallbox	
Use with stainless wallplate	
1-Gang	84071-40
2-Gang	84072-40
3-Gang	84073-40



84071-40



1221-2KL w/two keys



Related Products

Find the right wallplate for any application. See section T for Wallplates & Weather-Resistant Covers.

LEV-LOK® TOGGLE

Lev-Lok® Modular Switches

The revolutionary Lev-Lok® Modular Wiring Device System consists of a wiring module (locking connector with leads) and a rugged wiring device (receptacle or switch) with solid brass locking connection pins. By placing the wiring module over the device's locking pins and twisting clockwise, the connection is secured. Leviton's modular devices address the reliability and performance concerns of specification engineers without sacrificing contractors' needs for fast, easy installation.

Features and Benefits

- Devices constructed with impact-resistant thermoplastic nylon cover and body
- Four corner latches securely fasten the device's face to the body
- Solid brass locking pins for strong, secure connection between device and wiring module
- Wiring module locks and latches to the device
- Wiring module ships with protective cover, preventing debris from entering contacts until device is attached
- Modules have factory-installed circuit ID label. Electricians can save a step by labeling device locations during rough-in
- Switch covers are color-coded for easy identification of amp rating
- Backed by a limited 10-year warranty

Color Choices Lev-Lok® devices are offered in a wide range of colors. To order colors, add suffix to Cat. No.



White
(-W)



Ivory
(-I)



Light Almond
(-T)



Gray
(-G/-GY)



Black
(-E)



Brown



Red
(-R)



Yellow
(-Y)



Blue
(-B)



Orange
(-O)

Lev-Lok® Wiring Modules

Device Type	Description	
Single Pole Switches	Stranded Wire Leads (Black)	MSPSW-ST
	Stranded Wire Leads (Black) push wire connectors	MSPSW-WST
	Solid Wire Leads (Black)	MSPSW-SD
	Stranded Wire Leads (Brown to identify 277V applications)	MSPSW-7ST
	Solid Wire Leads (Brown to identify 277V applications)	MSPSW-7SD
3-Way Switches	Stranded Wire Leads #12 (Black, Red, Red, Green)	M3WSW-OST
	Stranded Wire Leads #12 with 4 port Push In wire connectors on all wires [Ground wire connector to be color coded Green] (Black, Red, Red, Green)	M3WSW-WST
	Stranded Wire Leads #12 for 277V Lighting Applications (Brown, Yellow, Yellow, Green)	M3WSW-7ST

LEV-LOK® TOGGLE

Lev-Lok® Extra Heavy-Duty Grade Modular Switches			
Rating		15A-120/277V AC	20A-120/277V AC
Description	Color	Cat. No.	Cat. No.
Standard Toggle Single Pole	White	M1201-W	M1221-W
	Ivory	M1201-I	M1221-I
	Light Almond	—	M1221-T
	Gray	M1201-GY	M1221-GY
	Brown	M1201	M1221
	Black	—	M1221-E
	Red	M1201-R	M1221-R
Illuminated Toggle Single Pole	White	M1201-LHW	M1221-LHW
	Ivory	M1201-LHI	M1221-LHI
	Clear	M1201-LHC	M1221-LHC
Tamper-Resistant† Key Single Pole	White	—	M1221-WL
	Ivory	M1201-IL	M1221-IL
	Gray	—	M1221-GL
	Brown	M1201-L	M1221-L
	Red	—	M1221-RL
Standard Toggle 3-Way Switches	White	M1203-W	M1223-W
	Ivory	M1203-I	M1223-I
	Light Almond	—	M1223-T
	Gray	M1203-GY	M1223-GY
	Black	—	M1223-E
	Brown	M1203	M1223
	Red	M1203-R	M1223-R
Illuminated 3-Way Toggle Switches	White	M1203-LHW	M1223-LHW
	Ivory	M1203-LHI	M1223-LHI
	Clear	M1203-LHC	M1223-LHC
Tamper-Resistant† Key 3-Way Toggle Switches	White	—	M1223-WL
	Ivory	M1203-IL	M1223-IL
	Gray	—	M1223-GL
	Brown	M1203-L	M1223-L
	Red	—	M1223-RL
†Replacement key for Tamper Resistant Switch		55500-PRT	—



M1221-I

DECORA®

Decora® Switches

Featuring a designer look and feel that qualify them as modern classics, Decora® rocker switches add so much at a modest cost that no fine home should be without them. Their sleek simplicity and smooth, quiet operation stem from quality materials fitted to tight tolerances and finished with great care, ensuring years of trouble-free service. Easy to wire, they work with tungsten, fluorescent and resistive loads. Their sturdy construction and dependable performance are everything you'd expect from the preeminent switch maker.

Sample Decora® Switches



Color Choices

Decora® switches are offered in a wide range of colors. To order colors, add suffix to Cat. No.



White
(-W)



Ivory
(-I)



Light Almond
(-T)



Gray
(-G/-GY)



Black
(-E)



Brown

Features and Benefits

All Decora® Switches

- Switch frame shields against dust and fits in wallplate to prevent rocker binding
- Terminal screws accept up to #12 AWG copper or copper-clad wire
- Quickwire push-in terminals accept #14 AWG solid copper wire only
- Sturdy construction for long service life
- Full-rated current capacity with tungsten, fluorescent or resistive loads. Motor capacity is 80% of switch rating
- Complements every décor
- Limited 2-year warranty

Illuminated Decora® Switches

- Illuminated switch rocker illuminates when load is OFF
- Pilot Light switch rocker visible when load is ON, even in bright light
- Illuminated switch does not require a neutral; Pilot light switch requires a neutral

Imprinted Decora® Switches

- Stock Decora® switches available with choice of three imprints on rocker: FAN, DISPOSAL, OIL BURNER

DECORA® | Quickwire Push-In and Side Wired

Quickwire Push-In and Side Wired Switches*			
Rating		15A-120/277V AC w/Ground Screw	15A-120/277V AC Self-grounding w/Ground Screw*
Description	Color	Cat. No.	Cat. No.
Single Pole	White	5601-2W	5601-P2W
	Ivory	5601-2I	5601-P2I
	Light Almond	5601-2T	5601-P2T
	Gray	5601-2GY	5601-P2G
	Black	5601-2E	5601-P2E
	Brown	5601-2	—
Double Pole	White	5602-2W	—
	Ivory	5602-2I	—
	Light Almond	5602-2T	—
	Black	5602-2E	—
3-Way	White	5603-2W	5603-P2W
	Ivory	5603-2I	5603-P2I
	Light Almond	5603-2T	5603-P2T
	Gray	5603-2GY	5603-P2G
	Black	5603-2E	5603-P2E
	Brown	5603-2	—
4-Way	White	5604-2W	—
	Ivory	5604-2I	—
	Light Almond	5604-2T	—
	Gray	5604-2GY	—
	Black	5604-2E	—
	Brown	5604-2	—

*Self-grounding when installed in a properly grounded metal box



5601-P2W



5603-2E



5604-2W

DECORA® | Illuminated and Imprinted

Decora® Switches

Quickwire and Side Wired — Illuminated*

Rating	15A-120V AC w/Ground Screw	
Description	Color	Cat. No.
Single Pole	White	5611-2W
	Ivory	5611-2I
	Light Almond	5611-2T
3-Way	White	5613-2W
	Ivory	5613-2I
	Light Almond	5613-2T
4-Way	White	5614-2W
	Ivory	5614-2I
	Light Almond	5614-2T

*Lens illuminated when load is OFF — does not require a neutral wire



5611-2W

Quickwire Push-In and Side Wired — Pilot Light*

Rating	15A-120V AC w/ground screw	
Description	Color	Cat. No.
Single Pole	White	5618-2W
	Ivory	5618-2I
	Light Almond	5618-2T

*Pilot light illuminated when load is ON



5618-2I

Quickwire and Side Wired — Imprinted

Rating	Stock	15A-120/277V AC w/ground screw	
Description	Color	Messages	Cat. No.
Single Pole, Stock or Custom Print	White	FAN, DISPOSAL,	5601-Z2W
	Ivory	OIL BURNER	5601-Z2I

Note: For Quickwire and Side Wired Molded made to order products, contact your Leviton sales representative



5601-Z2W

Decora Plus™ AC Quiet Commercial Specification Grade Rocker Switches

Decora Plus™ devices combine designer styling with all the benefits of rugged commercial grade construction. The robust product offering includes: single pole, double pole, 3- and 4-way switches, momentary and maintained contact switches, as well as pilot light and illuminated switches.

Features and Benefits

- Engineered for fine tolerances and top performance
- Decora Plus™ switches feature impact resistant thermoplastic construction for long service life
- All Decora® devices meet or exceed applicable UL, CSA and NOM testing standards

AC Quiet Rocker Switches

- Full rated current capacity with tungsten, fluorescent or resistive loads. Motor capacity is 80% of switch rating
- Back and side wiring terminals accept both solid and stranded wire to ease installation
- Architecturally-styled smooth-action concave rocker
- Heavy-duty impact-resistant thermoplastic construction for long service life in commercial applications
- Two ground connection options: a green grounding screw and a self-grounding clip
- Backed by a limited 10-year warranty

Canadian Switches

- Canadian Decora® wallplates available in a number of colors and fit “Commander Type” boxes

5691-2I

One-piece wrap-around heavy gauge steel strap incorporates locking tabs for extra strength

Triple combination-head mounting screws (straight slot, Phillips and Robertson head)

Decora Plus™ switches have patented concave rockers that present a low profile

Decora Plus™ switches feature back and side wiring terminals and accept both stranded and solid conductors

Self-grounding clip

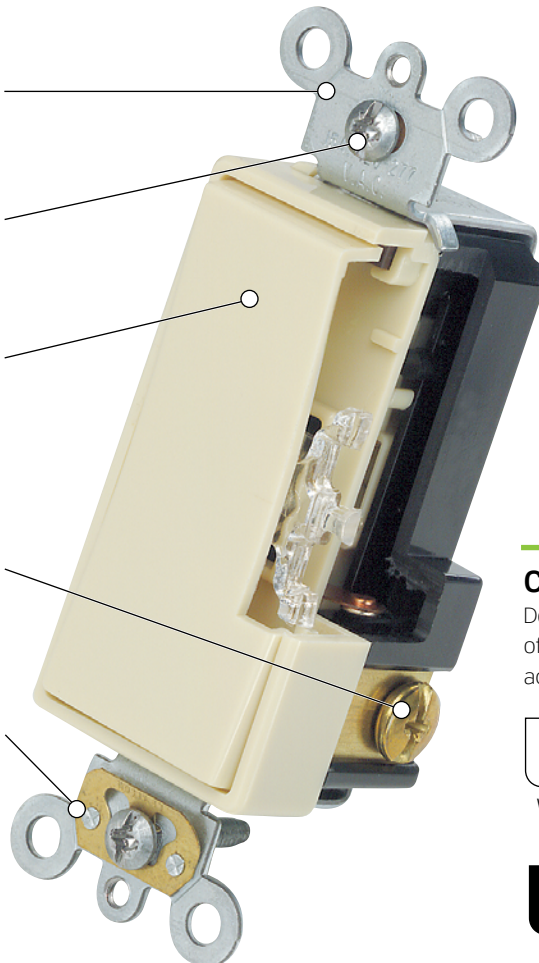

Color Choices

Decora Plus™ AC Quiet Rocker switches are offered in a wide range of colors. To order colors, add suffix to Cat. No.



White (-W)



Ivory (-I)



Light Almond (-T)



Gray (-G/-GY)



Black (-E)





Brown



Red (-R)

DECORA PLUS™ | AC Quiet Commercial Spec Grade
Decora Plus™ AC Quiet Commercial Specification Grade Rocker Switches

Back and Side Wired  			
Rating	15A-120/277V AC		20A-120/277V AC
Description	Color	Cat. No.	Cat. No.
Single Pole	White	5691-2W	5621-2W
	Ivory	5691-2I	5621-2I
	Light Almond	5691-2T	5621-2T
	Gray	5691-2GY	5621-2GY
	Black	5691-2E	5621-2E
	Brown	5691-2	5621-2
	Red	—	5621-2R
Double Pole	White	—	5622-2W
	Ivory	—	5622-2I
	Light Almond	—	5622-2T
	Gray	—	5622-2GY
	Black	—	5622-2E
3-Way	White	5693-2W	5623-2W
	Ivory	5693-2I	5623-2I
	Light Almond	5693-2T	5623-2T
	Gray	5693-2GY	5623-2GY
	Black	5693-2E	5623-2E
	Brown	5693-2	5623-2
	Red	—	5623-2R
4-Way	White	—	5624-2W
	Ivory	—	5624-2I
	Light Almond	—	5624-2T
	Gray	—	5624-2GY
	Brown	—	5624-2



5691-2GY



5693-CI

Back and Side Wired — Canadian  			
Rating	15A-120/347V AC		20A-120/347V AC
Description	Color	Cat. No.	Cat. No.
Single Pole	White	5691-CW	5621-CW
	Ivory	5691-CI	5621-CI
	Light Almond	—	5621-CT
	Gray	5691-CG	—
	Black	5691-CE	—
	Red	5691-CR	—
3-Way	White	5693-CW	5623-CW
	Ivory	5693-CI	5623-CI
	Light Almond	—	5623-CT
	Gray	5693-CG	5623-CG
	Black	5693-CE	—
4-Way	White	5694-CW	5624-CW

Decora Plus™ Maintained and Momentary Contact Switches
Features and Benefits

- Full rated current capacity with tungsten, fluorescent or resistive loads. Motor capacity is 80% of switch rating
- Wrap-around heavy-gauge strap with locking tabs for added strength
- Back and side wiring terminals accept both solid and stranded wire to ease installation
- Backed by a limited 10-year warranty

Back and Side Wired — Momentary Contact
Rating 15A-120/277V AC

Description	Color	Cat. No.
Single Pole,	White	5657-2W
Double Throw,	Ivory	5657-2I
Center Off	Light Almond	5657-2T
	Gray	5657-2GY
	Black	5657-2E
	Brown	5657-2



5657-2W

Back and Side Wired — Maintained Contact
Rating 15A-120/277V AC

Description	Color	Cat. No.
Single Pole,	White	5685-2W
Double Throw,	Ivory	5685-2I
Center Off	Light Almond	5685-2T
	Gray	5685-2GY
	Black	5685-2E
Double Pole,	White	5686-2W
Double Throw,	Ivory	5686-2I
Center Off	Light Almond	5686-2T



5686-2I

DECORA PLUS™ | Commercial Spec Grade Illuminated | Pilot Light

Decora Plus™ Commercial Specification Grade Illuminated and Pilot Light Switches

Features and Benefits

- Illuminated when load is OFF
- Pilot Light rocker visible when load is ON, even in bright light
- Back and side wiring terminals accept both solid and stranded wire to ease installation
- Two ground connection options: a green grounding screw and a self-grounding clip

Back and Side Wired — Illuminated*

Rating	20A-120V AC		20A-277V AC
Description	Color	Cat. No.	Cat. No.
Single Pole	White	5631-2W	5649-2W
	Ivory	5631-2I	—
	Light Almond	5631-2T	—
	Black	5631-2E	—
3-Way	White	5633-2W	5659-2W
	Ivory	5633-2I	—
	Light Almond	5633-2T	—

*Does not require a neutral wire



5631-2W

Back and Side Wired — Pilot Light**

Rating	20A-120V AC		20A-277V AC
Description	Color	Cat. No.	Cat. No.
Single Pole	White	5628-2W	5629-2W
	Ivory	5628-2I	—
	Light Almond	5628-2T	—
	Brown	5628-2	—
3-Way	White	5638-2W	5639-2W
	Ivory	5638-2I	—

**Requires a neutral wire



5628-2T



5638-2W

Appliance Switches

Features and Benefits

Single Pole Pull Chain Switches

- Standard finish of metal chain is nickel
- Standard leads are #18 AWG 105°C plastic, 6" long, stripped 1/2"
- 3 3/4" chain connector, 3' braided cord, end bell
- Bushing 3/8 - 27 x 3/8" long
- Piercing 13/32" dia

Door Jamb Switch

- Bushing 15/32-32 x 9/16" long

Single Pole Pull Chain Switches

Rating	3A 125V AC-L	6A 125V AC	3A 250V AC	1/4 HP 125/250V
Description	Sequence		Cat. No.	
Heavy Duty, Single Circuit, Black and Red Leads	ON-OFF (L1, OFF)		1689-75	
Heavy Duty, Two Circuit, Four Positions, Black, Blue, Red Leads	LOW-MED-HIGH-OFF (L1, L2, L1 & 2, OFF)		1689-50	
Heavy Duty, Two Speed, Four Positions, Black, Blue, Red Leads	ONE-OFF-TWO-OFF (L1, L2, L3, OFF)		1691-50	

Rating	3A 125V	1A 125VT	1A 250V
Description	Sequence		Cat. No.
Compact, Single Circuit, Black Leads	ON-OFF		10097-8

Rating	3A 125V AC-L	6A 125V AC	3A 250V AC
Description	Sequence		Cat. No.
Compact, Single Circuit, Black Leads	ON-OFF		10041-500

Continued on next page



1689-75





10041-500



10097-8



APPLIANCE | Push-Button Door Jamb | Feed-Through Cord | Miniature Feed-Through Cord

Appliance Switches

Push-Button Door Jamb Switch  		
Rating	3A 125V	
Description	Sequence	Cat. No.
Single Circuit, Momentary, Metal Pushbutton, #18 AWG Leads, with Jamb Box, Mounting Screws and Cover Plate	NORMALLY ON	1865





1865

Feed-Through Cord Switch  			
Rating	3A 125V 1/2 HP 125V		
Description	Sequence	Color	Cat. No.
Heavy Duty, Single Pole, 18/2 - 16/2 Type SPT-1, SPT-2 or Round Cord 18/2, Type SVT and other cords up to 9/32" outer jacket	ON-OFF	White	5410-W
		Ivory	5410-I
		Brown	5410



5410-W

Miniature Feed-Through Cord Switch  			
Rating	3A 125V 1/2 HP 125V		
Description	Sequence	Color	Cat. No.
Miniature Single Pole, Captive Screw (for use with #18 ga. SPT-1 conductors)		White	423-3W
		Ivory	423-3I
		Brown	423-3



423-3I

Decora® RF Anywhere Remote Switch

The Anywhere Decora® RF remote 3-way switch is perfect for those who desire the convenience of an extra indoor wall switch without the hassle of installing additional wiring. Using wireless radio frequency transmitters to turn lights on and off from two locations, it easily replaces a single-pole switch and fits into a standard wallbox. Ideal for stairwells, entrances, garages, basements, children's rooms or any room of your choice.

Features and Benefits

Anywhere Switch/Switch RF Remote (6696-W)

- Adds the convenience of an extra indoor wall switch wherever needed without installing additional wiring
- The receiver takes the place of (and wires like) an ordinary single-pole switch and fits in a standard wallbox
- Uses wireless radio frequency (RF) transmitters and receivers to turn lights ON and OFF from two locations
- Can be placed at a low height for convenient light control from bedside. Excellent for universal design applications
- The control signal passes through walls and floors, operating receivers up to 50 feet away
- Two operating channels with different frequencies prevent interference when two units are operating in one home
- Compatible with Decora® devices; comes with matching wallplate

Anywhere Switch/Plug-In RF Remote (6697-W)

- Adds the convenience of a switched outlet without installing additional wiring
- The receiver plugs into a standard 15 or 20 Amp outlet
- Uses wireless radio frequency (RF) transmitters and receivers to turn lamps or small appliances within 50 feet ON and OFF
- Can be placed at a low height for convenient light control from bedside. Excellent for universal design applications
- The control signal passes through walls and floors, operating receivers up to 50 feet away
- Two operating channels with different frequencies prevent interference when two units are operating in one home
- Compatible with Decora® devices; comes with matching wallplate

Decora® Anywhere Switch

Description	Rating	Cat. No.
Anywhere Switch/Switch RF Remote Decora®	300W - 120V AC 60 Hz	6696-W
Anywhere Switch/Plug-In RF Remote Decora®	600W Incandescent/ 300W Fluorescent/ 600W Appliance @ 120V AC-60Hz	6697-W



6696-W



6697-W

MOTOR STARTER | Manual Starting Switches

AC Manual Motor Starting Switches

Leviton manual motor controllers are available as either single switches or with enclosures. Available enclosures include Type 1 thermoplastic, Type 1 powder-coated metal, Type 3R powder-coated metal or Type 4 non-metallic.

MS403-DS

Suitable as Motor Disconnect

All 30A and 40A motor starters are listed suitable as motor disconnect when protected by a 30A time-delay fuse.

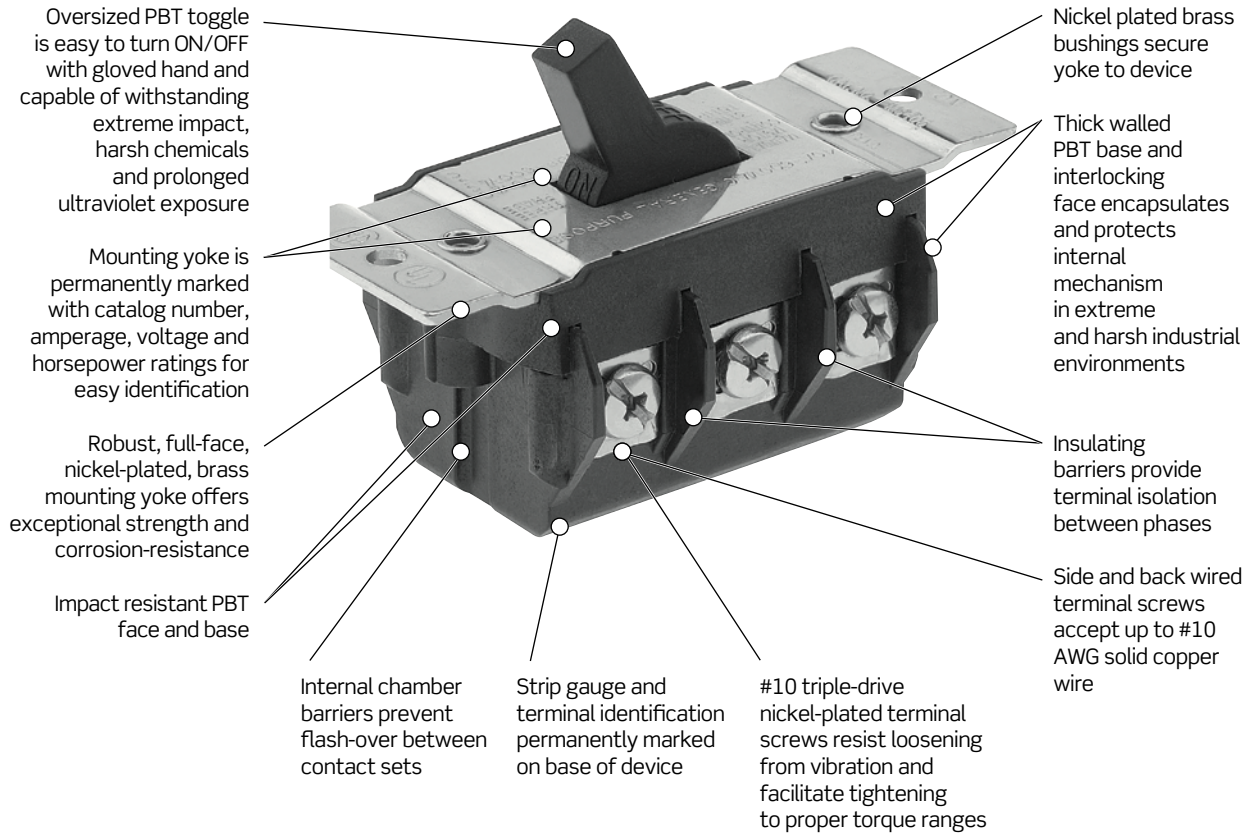

MS602-FW

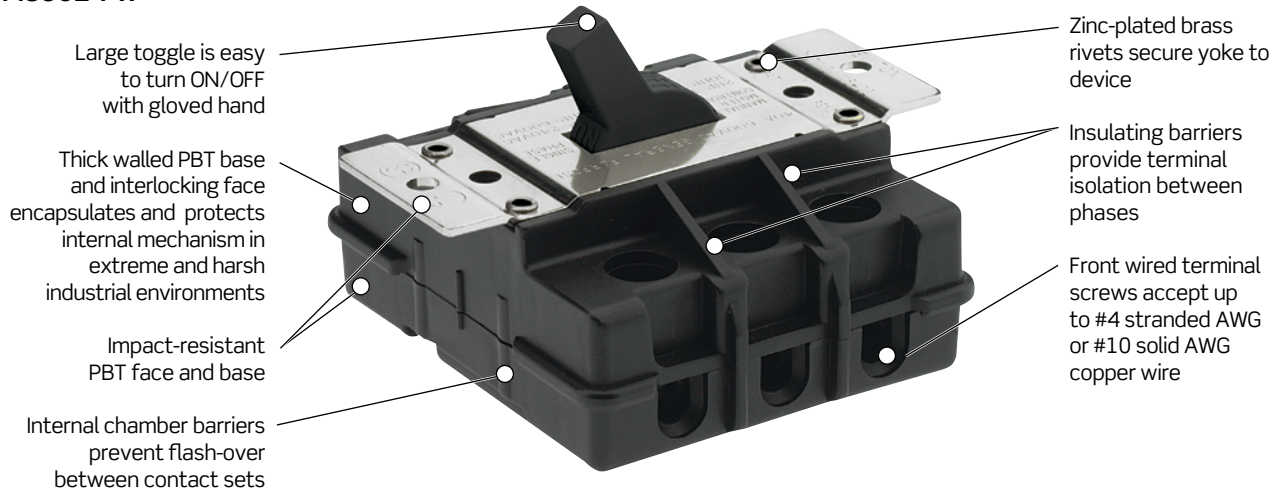

Features and Benefits

Motor Starting Switches

- All molded parts are thermoplastic to resist impacts, chemicals, temperature, tracking and arcing
- 30 Amp and 40 Amp switches are listed suitable as motor disconnect when protected by a 30 Amp time-delay fuse
- Positive-contact design and cam-driven mechanism enhances fast-make/slow-break
- Silver-alloy contacts for maximum conductivity and service life
- Multiple termination design accepts back and side wiring, terminal clamps or ring terminals
- Back and side wire terminals accept up to #10 AWG solid copper wire. For stranded #8 AWG wire, remove terminal clamp and use ring terminal (sold separately)
- Oversized #10 triple-drive terminal screws provide greater torque and resist backing out from vibration
- Insulating barrier between terminals provide isolation from each phase
- Nickel-plated brass mounting strap for superior corrosion resistance
- Large toggle provides positive actuation, even with gloved hand
- Backed by a limited 10-year warranty

Welder Starting Switch

- Capable of accommodating bus bar termination in multi-gang applications
- Hole for mounting hardware supports panel mounting with self-threading fasteners or pop rivets
- Terminal screws accept up to #10 AWG solid copper wire. For stranded #8 AWG wire, remove terminal clamp and use ring terminal (sold separately)
- Fast-threading, corrosion-resistant brass triple-drive screws for fast, easy installation
- Backed by a limited 10-year warranty

Sample Motor Starting Switches



MOTOR STARTER | Manual Starting Switches

AC Manual Motor Starting Switches
30A-600V AC — Suitable as Motor Disconnect

30A Motor Starting without Overload Protection

Switch Type	Pole	Phase	Description	Wiring Position	AC HP Rating				Cat. No.
					120V	240V	480V	600V	
Motor Switch NEMA Type 1 Enclosure	2P	1Ø	Metal Gray Enclosure	Back & Side	2HP	5HP	10HP	15HP	N1302-DS
	3P	3Ø	Metal Gray Enclosure	Back & Side	3HP	7.5HP	15HP	20HP	N1303-DS
	3P	3Ø	Thermoplastic Black Enclosure*	Back & Side	3HP	7.5HP	15HP	20HP	N1303-TDS
Motor Switch NEMA Type 3R Enclosure	2P	1Ø	Metal Gray Enclosure	Back & Side	2HP	5HP	10HP	15HP	N3302-DS
	3P	3Ø	Metal Gray Enclosure	Back & Side	3HP	7.5HP	15HP	20HP	N3303-DS
Motor Switch NEMA Type 4X Enclosure	2P	1Ø	Thermoplastic Gray Enclosure**	Back & Side	2HP	5HP	10HP	15HP	MS4X-302
	3P	3Ø	Thermoplastic Gray Enclosure**	Back & Side	3HP	7.5HP	15HP	20HP	MS4X-303
Motor Switch Only	2P	1Ø	Black Standard Toggle Switch	Back & Side	2HP	5HP	10HP	15HP	MS302-DS
	2P	1Ø	Black Short Toggle Switch	Back & Side	2HP	5HP	10HP	15HP	MS302-DSS
	3P	3Ø	Black Standard Toggle Switch	Back & Side	3HP	7.5HP	15HP	20HP	MS303-DS
	3P	3Ø	Black Short Toggle Switch	Back & Side	3HP	7.5HP	15HP	20HP	MS303-DSS

*Enclosure has black thermoplastic cover with steel box.

**4X Enclosures are high impact Valox™ in watertight enclosure rated 4X, 3R, 12K and IP67

40A-600V AC — Suitable as Motor Disconnect

40A Motor Starting without Overload Protection

Switch Type	Pole	Phase	Description	Wiring Position	AC HP Rating				Cat. No.
					120V	240V	480V	600V	
Motor Switch NEMA Type 4X Enclosure	2P	1Ø	Thermoplastic Gray Enclosure*	Back & Side	2HP	5HP	10HP	15HP	MS4X-402
	3P	3Ø	Thermoplastic Gray Enclosure*	Back & Side	3HP	7.5HP	15HP	20HP	MS4X-403
Motor Switch Only	2P	1Ø	Black Standard Toggle Switch	Back & Side	2HP	5HP	10HP	15HP	MS402-DS
	2P	1Ø	Black Standard Toggle Switch	Back & Side	2HP	5HP	10HP	15HP	MS403-DS

*4X Enclosures are high impact Valox™ in watertight enclosure rated 4X, 3R, 12K and IP67

MOTOR STARTER | Manual Starting Switches | Welder Switch

60A-600V AC — These items are **NOT** Suitable as Motor Disconnect

Motor Starting without Overload Protection									
Switch Type	Pole	Phase	Description	Wiring Position	AC HP Rating				Cat. No.
					120V	240V	480V	600V	
Motor Switch NEMA Type 3R Enclosure	2P	1Ø	Metal Black Enclosure	Front	—	10HP	15HP	20HP	N3602
	3P	3Ø	Metal Black Enclosure	Front	—	10HP	25HP	30HP	N3603
Motor Switch Only	2P	1Ø	Black Standard Toggle Switch	Back	—	10HP	15HP	20HP	MS602-BW
	2P	1Ø	Black Standard Toggle Switch	Front	—	10HP	15HP	20HP	MS602-FW
	3P	3Ø	Black Standard Toggle Switch	Back	—	10HP	25HP	30HP	MS603-BW
	3P	3Ø	Black Standard Toggle Switch	Front	—	10HP	25HP	30HP	MS603-FW

30A, 40A and 60A Enclosures Only

Suitable as Motor Disconnect			
Switch Type	Used With	Description	Cat. No.
Enclosure Only NEMA Type 1	30A	Metal Gray Enclosure	N13NC-DS
	30A	Thermoplastic Black Enclosure*	N13NC-TDS
Enclosure Only NEMA Type 3R	30/40A	Metal Gray Enclosure	N33NC-DS
Enclosure Only NEMA Type 3R	60A	Metal Gray Enclosure	N36NC

*Enclosure has black thermoplastic cover with steel box

Welder Switch

40A-600V AC

Motor Starting without Overload Protection						
Switch Type	Pole	Phase	Description	Wiring Position	AC HP Rating 250V	Cat. No.
Welder Switch Only	2P	—	Black Standard Toggle Switch	Back	5HP	WS402

SAFETY DISCONNECT SWITCHES

Powerswitch® Safety Disconnect Switches

Watertight and dust-tight Powerswitch® Safety Disconnect Switches are the ideal choice for process environments with particulate laden air, outdoor exposure, or water wash-down requirements. Heavy duty enclosed safety disconnect switches cut power to the circuit for equipment servicing and are designed to withstand higher short circuit currents than manual motor controllers.

Sample Safety Disconnect Switches



Features and Benefits

30 Amp

- Non-Fused and Fused
- IP67 Watertight
- NEMA 4X and IEC (DS30-AX)
- Fused models accept “Class-J” Time-Delay Fuses
- Backed by a limited 2-year warranty

60 Amp

- Non-Fused and Fused
- IP67 Watertight
- Hub sold separately
- Fused models accept “Class-J” Time-Delay Fuses
- Backed by a limited 2-year warranty

100 Amp

- Non-Fused
- IP67 Watertight
- Hub sold separately
- Fused models accept “Class-J” Time-Delay Fuses
- Backed by a limited 2-year warranty

SAFETY DISCONNECT SWITCHES

Powerswitch® Safety Disconnect Switches

Powerswitch® DS30-AX

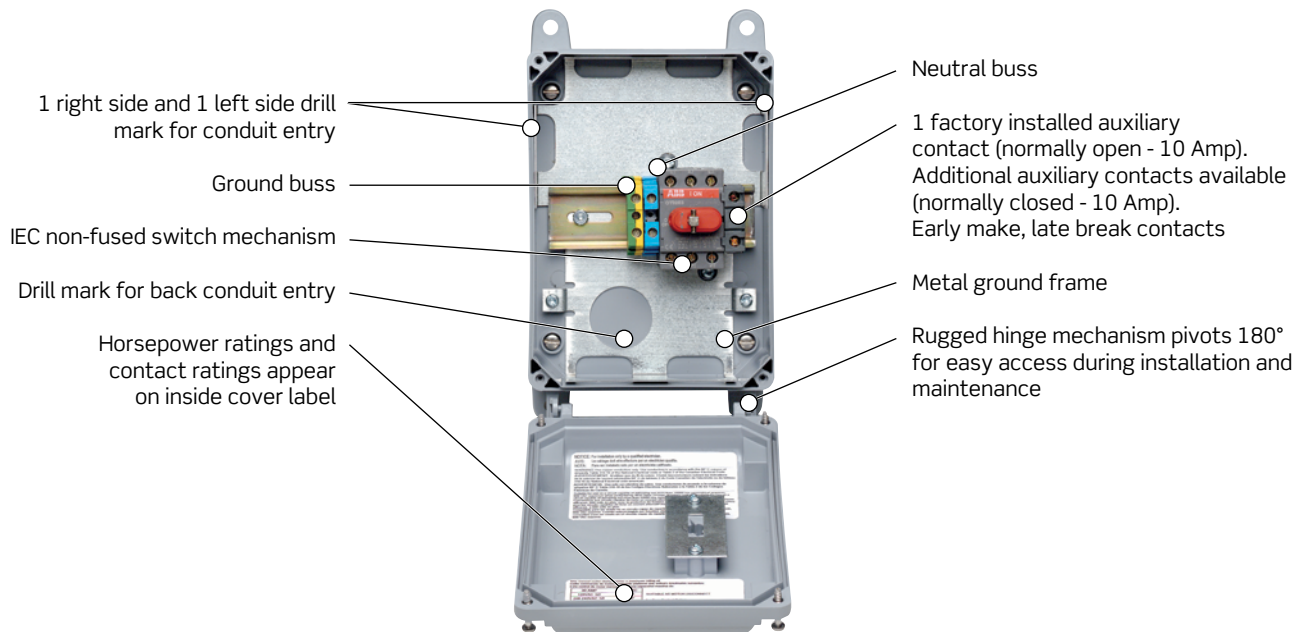
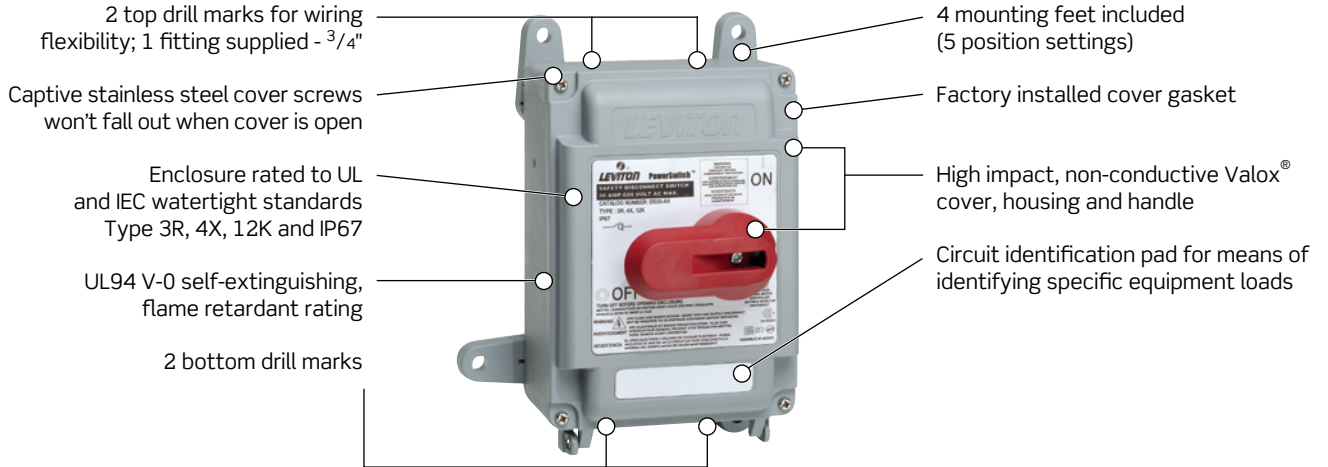

SAFETY DISCONNECT SWITCHES

Powerswitch® Safety Disconnect Switches

Powerswitch® DS60-FAX

Liquid-tight conduit fitting (sold separately) can be installed for top or bottom feed

Stainless steel screws are captive and will not fall out when cover is opened

Integrated lockout handle meets OSHA safety regulations

Impact UV and chemical-resistant Valox enclosure rated to UL and IEC watertight standards

- 3R, 4X & 12K
- IP67

Red “pistol grip” handle provides visual confirmation of switch’s status

Circuit identification pad for means of identifying specific equipment loads

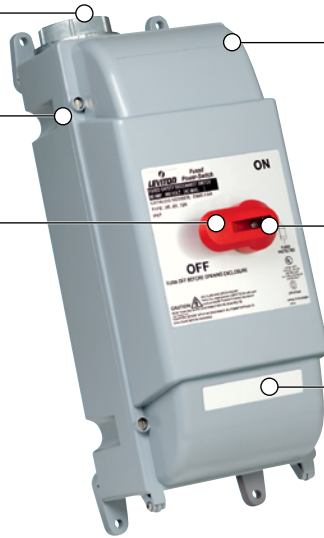

Pre-wired grounding plates (top and bottom of enclosure) connect to metal conduit grounding system

Disconnect switch with integrated fuse holder offers proven performance in a compact package

- Fused cartridges accept “Class J” fuses (not included)
- 1 factory installed auxiliary contact (normally open – 10 Amp)
- Additional auxiliary contact available (normally closed – 10 Amp)
- Easily accessible neutral and ground terminal blocks

Brass threaded inserts will not strip, provide higher torque, and form tighter seal between back box and cover

Generous wiring space for top to bottom wiring

Rugged hinge mechanism pivots 180° for easy access during installation and maintenance

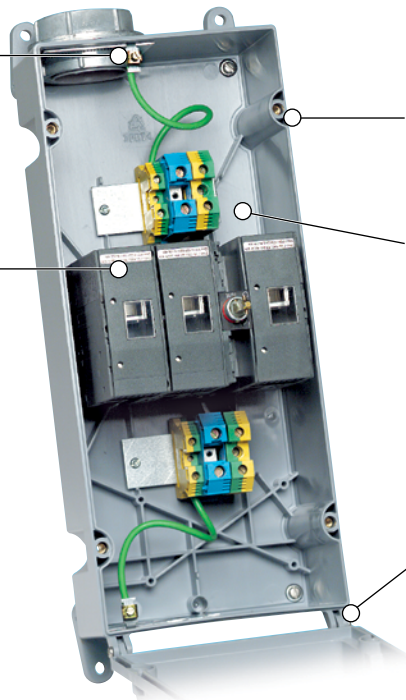

Handle (with padlock installed)

Cover Screws:
1-1/8" deep slotted, LG stainless steel

Mounting Screws:
10-24 x 1/2" deep slotted, LG stainless steel

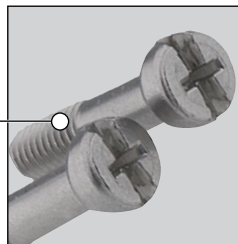

SAFETY DISCONNECT SWITCHES
Safety Disconnect Switches

Description	Amps	Max Voltage	RMS Symmetrical Amperes	Cat No.
Disconnect Switch Non-Fused*	30	600V AC	10,000A	DS30-AX
	60	600V AC	50,000A	DS60-AX
	100	600V AC	50,000A	DS100-AX
Disconnect Switch Fused**	30	600V AC	200,000A	DS30-FAX
	60	600V AC	200,000A	DS60-FAX

*Non-Fused are suitable for use on circuits capable of delivering not more than the RMS symmetrical amperes listed on the chart above.

**Fused, when protected by Class J fuses, 600V AC maximum, are suitable for use on circuits capable of delivering not more than the RMS symmetrical amperes listed on the chart above

Maximum HP Ratings as Per UL 508

Volts	DS30-AX	DS60-AX	DS100-AX	DS30-FAX	DS60-FAX
	Non-Fused	Non-Fused	Non-Fused	Fused	Fused
120V AC	2	2	5	2	N/R
208V AC	5	20	25	7.5	15
240V AC	5	10	15	3	N/R
480V AC	10	20	25	7.5	N/R
600V AC	N/A	20	20	20	N/R
3Ø Y120/208V AC	10	20	25	7.5	15
3Ø 240V AC	10	20	30	7.5	15
3Ø 480V AC	20	40	50	15	30
3Ø 600V AC	25	40	50	20	50

N/R: Not rated

N/A: Not available

SWITCHED ENCLOSURES | EDSR-23 and MIDSR-23

Powerswitch® Switched Enclosures

Our Powerswitch® switched enclosure devices combine a 30A, non-fused safety disconnect switch and a NEMA locking receptacle in the same enclosure for easier installation and maintenance. These disconnect switches with receptacles are non-metallic, watertight and are engineered to enhance safety and performance for critical power control installations.

MIDSR-23

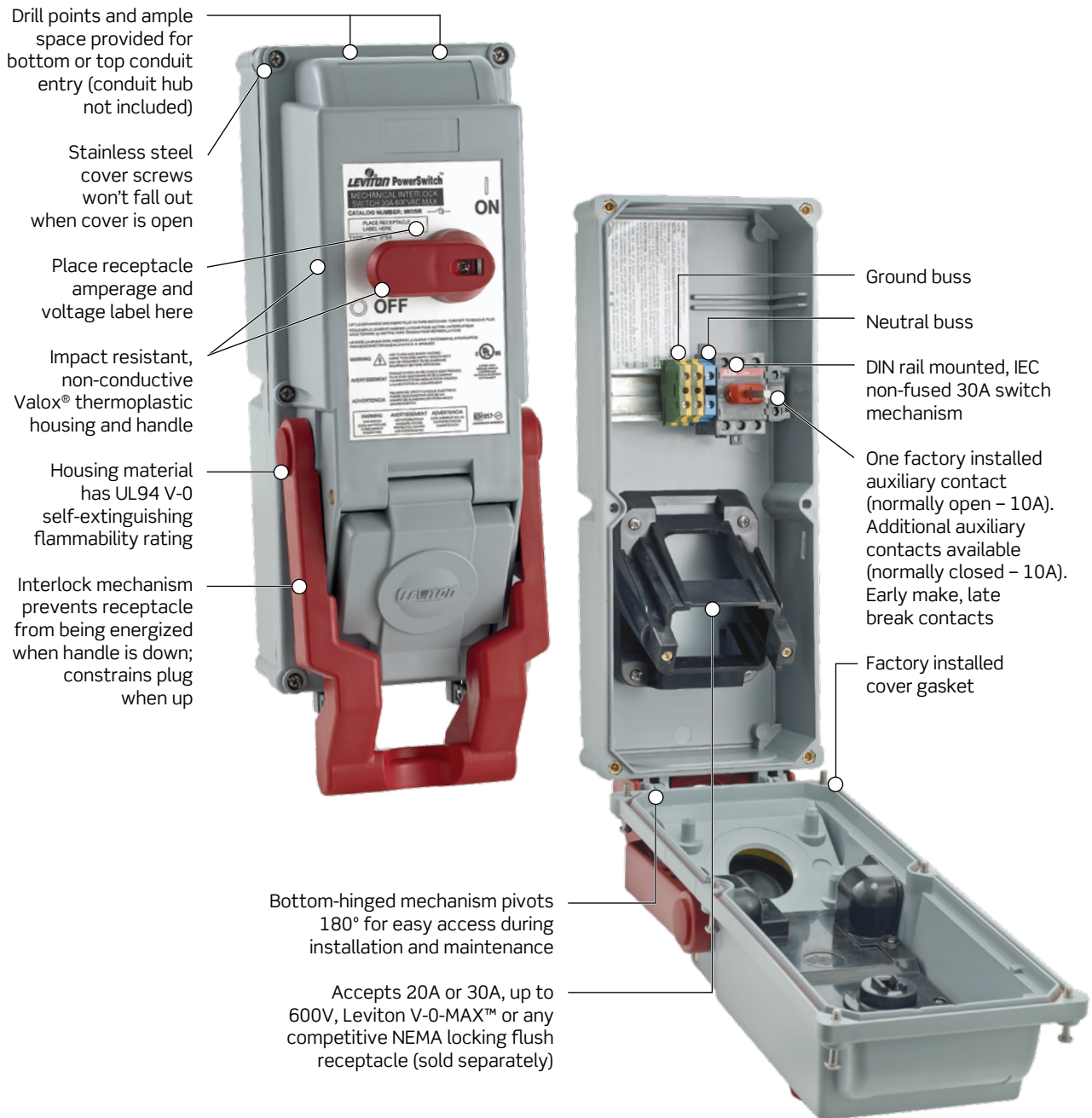

Features and Benefits

- Meet the requirements of outdoor/indoor installations, conforming to IP 66, UL Standard 50 and NEMA environmental ratings of 4X, 12K only when used in conjunction with Leviton Wetguard® plugs
- Meets the requirements of outdoor/indoor installations conforming to IP 54 and NEMA 3R with standard locking NEMA plugs and receptacles with cover closed when not in use
- For use with 20A-30A NEMA locking receptacles up to 600V (sold separately)
- Provide ON-OFF switched control for a connected load
- Lockout capability in compliance with OSHA Lockout/Tagout Regulation 29 CFR Part 1910.147 (in the OFF position) with an acceptable padlock/shackle, thereby assuring the connected equipment cannot be energized
- Auxiliary contact open prior to the line contacts for pilot duty switching
- Backed by a limited 2-year warranty
- Suitable for use on circuits capable of delivering not more than 10,000 RMS symmetrical amperes
- Certified to UL 231 and UL 686, UL 98 Fused, UL 508 Non-Fused, CSA C22.2 CE, IEC 60309-1 and 60309 2 standards

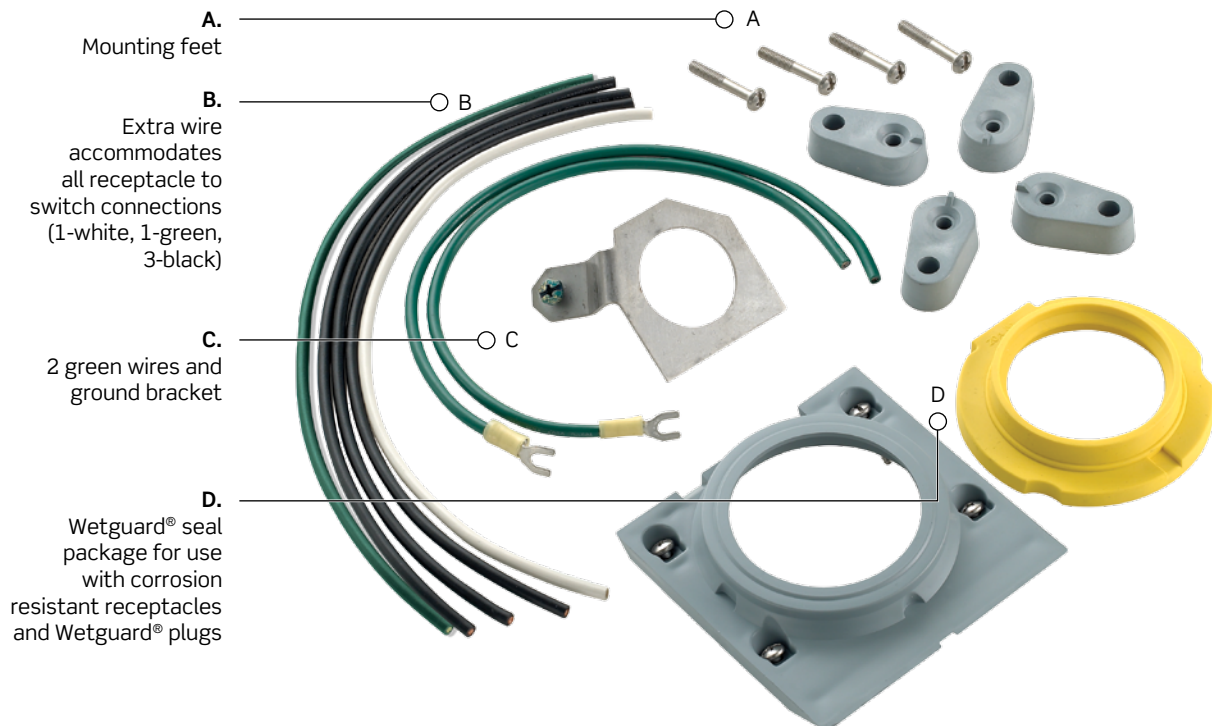
Powerswitch® EDSR-23 and MIDSR-23 30A 600V AC Mechanically Interlocked Disconnect Switch with Receptacle Bracket
Powerswitch® EDSR-23 and MIDSR-23 Accessories (included)

POWERSWITCH® SAFETY DISCONNECT | EDSR-23 and MIDSR-23

Powerswitch® Switched Enclosures
Switched Enclosure Devices

Description	Amps	Max Voltage	Short Circuit Current Withstand	Cat No.
Enclosed Disconnect Switch with Receptacle Bracket	30	600V AC	10,000A	EDSR-23
Mechanically Interlocked Disconnect Switch with Receptacle Bracket	30	600V AC	10,000A	MIDSR-23

Maximum HP Ratings as Per UL 508

Volts	EDSR-23 Non-Fused	MIDSR-23 Non-Fused
120V AC	2	2
208V AC	5	5
240V AC	5	5
480V AC	10	10
600V AC	N/A	N/A
3Ø Y120/208V AC	10	10
3Ø 240V AC	10	10
3Ø 480V AC	20	20
3Ø 600V AC	25	25

N/A: Not available



EDSR-23



MIDSR-23